

ÜRÜN KATALOĐU

Temmuz 2023 |||||2023-2

CETA FORM



Atölye Ekipmanları | El Aletleri | Otomotiv Aletleri

www.cetaform.com





CETA FORM

Değerli Müşterimiz,

Sizlere verdiğimiz hizmet kalitesini ve ürün çeşitliliğini artırmak amacıyla yatırımlarımıza hız kesmeden devam etmekteyiz. 2022 yılında 1 hat olarak devreye almış olduğumuz sıcak dövme tesisimize 2 hat daha ilave ediyoruz. Bu yatırım ile sıcak dövme kapasitemiz oldukça artmış olacaktır ve bu durum stoktan teslimat oranımıza çok olumlu yansiyacaktır.

Bunun yanında artan kapasite ihtiyacına istinaden, İstanbul Silivri’de toplamda yaklaşık 10.000 m²’lik bir kapalı alana sahip yeni tesisimizin inşaatına da Ağustos 2023 itibarı ile başlıyoruz. 2024 yılında devreye alınması planlanan bu tesis ile birlikte toplam kapalı alanımız yaklaşık 25.000 m²’ye ulaşacaktır.

Ceta Form olarak sürdürülebilirlik alanında da ciddi adımlar atmaya başladık. Bu doğrultuda mevcut fabrikamızda güneş paneli kurulumu Haziran ayında tamamlanmıştır. Dövme tesisimizde de bu kurulum 2023 yılı içerisinde tamamlanacaktır. Bunun yanında geri dönüşebilir ambalaj malzemeleri ve plastiklerin kullanımı, enerji tasarrufu sağlayan ekipmanlara yatırım gibi konular 2023 hedeflerimizde ilk sıralardadır. 2024 yılı itibarı ile yeşil dönüşümünü tamamlamış bir firma olmayı amaçlıyoruz.

Yılın ilk yarısında yaşanan yüksek maliyet artışı kaynaklı olarak güncellediğimiz yeni fiyatlarımızı içeren 2023-2 no.lu fiyat listemizi sizlere sunuyoruz.

Süre gelen desteğiniz için teşekkür eder, güçlü işbirliği ve kalıcı dostluğumuzun devamını dileriz.

Saygılarımla
Cemil Tayman



İÇİNDEKİLER

Ceta Form Hakkında	2-3
Ürünler	4-179
Teşhir Üniteleri	180
Stoktan Kalkan Ürünler	181
Nümerik İndeks	182-192
Ceta Form Garantisi	193

1	TAKIM ARABALARI VE ALET SETLERİ		4-35
2	ANAHTARLAR VE ALLENLER		36-48
3	LOKMA ANAHTARLAR VE AKSESUARLARI		49-74
4	TORK ANAHTARLARI		75-76
5	TORNAVİDALAR VE BİTS UÇLAR		77-98
6	PENSELER VE KESİCİLER		99-108
7	1000V İZOLELİ ALETLER VE MULTİMETRELER		109-119
8	MİKRO TORNAVİDALAR VE PENSELER		120-126
9	TESİSATÇI ALETLERİ		127-128
10	KESİCİ ALETLER VE EĞELER		129-139
11	ÇEKİÇ VE KESKİLER		140-142
12	ÖZEL OTOMOTİV ALETLERİ		143-161
13	ÖLÇÜ ALETLERİ		162-164
14	GENEL BAKIM VE ATÖLYE ALETLERİ		165-179
15	TEŞHİR ÜNİTELERİ		180

EL ALETLERİ UZMANI

Ceta Form, Türkiye'nin lider el aletleri üreticisi olan 48 yıllık bir kuruluştur. İstanbul'daki modern fabrikamızda tüm sektörlerdeki profesyonel kullanıcılar için yüksek kaliteli el aletleri geliştirir ve üretiriz. Türkiye'deki geniş bayi ağımızın yanında, yaklaşık 45 ülkede distribütörlerimiz ve İngiltere'de kendimize ait satış ofisimiz bulunmaktadır.



NEDEN CETA FORM



En Geniş Ürün Programı

Türkiye'deki el aletleri üreticileri arasında en geniş ürün çeşidini Ceta Form sunar; ürün programımız 4.000'in üzerinde ürün kalemi içermektedir. Müşterilerimiz tek kaynaktan ihtiyaçlarını karşılar, operasyon maliyetlerini düşürürler.



Ürün Tasarımları

Yeni ürün tasarımları konusunda Ceta Form çok ileri düzeydedir. Ürünlerimiz fonksiyonellik ve estetiğin zirve noktasındaki birleşimidir. İyi tasarımın getirdiği verimlilik artışının farkında olan tüketiciler, ürünlerimizden vazgeçmezler.



Güvenilir Lojistik

Katalogumuzda bulunan ürünlerin çok büyük bir kısmı stoklarımızda her zaman mevcuttur. Stoktan yüksek oranlı ve hızlı teslimatlar gerçekleştiririz. Stokta bulunmayan ürünler konusunda ise çabuk çözümler sunarız.



Detaylı Eğitim Programları

2 adet showroom aracımız ile tüketim noktalarını yoğun bir şekilde ziyaret eder ve eğitimler gerçekleştiririz; talep üzerine bayilerimizin belirleyeceği noktaları da ziyaret ederiz. Genel merkezimizdeki eğitim tesislerimiz de bayilerimizin ve kullanıcıların hizmetindedir.



Yenilikçi Firma

Sektörümüzün en yenilikçi firmasıyız. Modüler takım dolabı sistemleri ve özel otomotiv aletleri gibi yeni ürünleri Türk tüketicisi ile ilk buluşturan firma Ceta Form'dur. Ürün programımıza sürekli olarak tüketicilerimiz için katma değer sağlayan yeni ürünler eklenir.



Kaliteli Üretim

Ceta Form ISO 9001 onaylı bir üreticidir. Üretimimizde en iyi malzemeler ve en modern üretim teknikleri kullanılır; tüm kritik aşamalarda sıkı kalite kontrol uygulanır. Sonuç olarak aldığımız ürün şikâyetleri yok denecek düzeydedir.



Özel Teşhir Çözümleri

Müşterilerimizin satış noktalarına özel, çarpıcı ve yüksek satış cirosu sağlayan teşhir konseptleri geliştiririz; son tüketicilerin Ceta Form ürünlerini anlamasını ve satın almasını kolaylaştırırız.



Satış Destek Departmanımız

Konusunda tecrübeli çalışanlardan oluşan satış destek departmanımız tüm soru ve sorunlarınıza çabuk geri dönüş sağlar; e-mail, EDI, faks ve telefon ile siparişlerinizi alır. Hizmet kalitemiz üst düzeydedir.

ÜRETİMDE MÜKEMMELLİK

Ceta form el aletleri ve atölye ekipmanları üretim ve tasarımında 50 yılı yakın tecrübesi ile, yüksek kalite standartları ve üretim mükemmeliyeti ile özdeşleşmiştir. 2 ayrı üretim tesisimizde tek çatı altında onlarca farklı proses yürütmekteyiz. Entegre bir üretici olmamızdan dolayı kritik tüm süreçler %100 kontrolümüz altındadır.

■ ÜRÜN GELİŞTİRME VE TASARIM

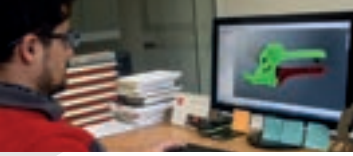

■ SICAK DÖVME



■ KALIP ÜRETİMİ



■ CNC İŞLEME

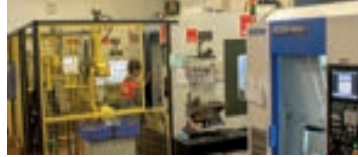

■ ROBOTİK ZİMPARALAMA



■ ÇELİK SAC ŞEKİLLENDİRME



■ PLASTİK ENJEKSİYON



■ PLASTİK ŞİŞİRME



■ PVC DALDIRMA



■ LOJİSTİK



3 ÜRETİM VE LOJİSTİK TESİS

Ceta Form 3 farklı lokasyondaki üretim ve lojistik tesislerinde faaliyet göstermektedir.

FABRİKA-1: ÜRETİM, SEVKİYAT VE YÖNETİM MERKEZİ



FABRİKA-2: SICAK DÖVME TESİSİ



SERBEST BÖLGE DEPOSU: ULUSLARARASI LOJİSTİK



BELGELENDİRİLMİŞ KALİTE

Ceta Form DIN/ISO kalite standartlarının üzerinde belirlediği firma içi ürün standartları ve uluslararası yönetim standartları doğrultusunda faaliyet göstermektedir. Canlı akım altında kullanılan birçok izoleli el aletlerimiz VDE tarafından test edilmiş, onaylanmış ve belgelendirilmiştir.

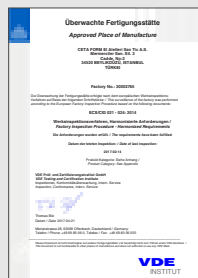
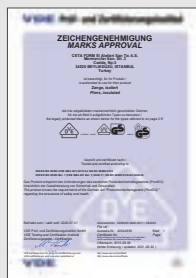
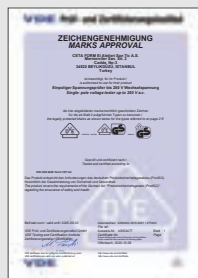

1000 V
EN 60900



1 Takım Arabaları ve Alet Setleri

4 | 35



A01M Serisi

GT-MAX Takım Arabaları (Boş)



KOD NO	Çekmece	YxGxD / mm	kg	FİYAT/TL
A01M-06	6	1018x746x458	67	
A01M-07	7	1018x746x458	67	
A01M-08	8	1018x746x458	70	

A01 Serisi

GT-PLUS Takım Arabaları (Boş)



KOD NO	Çekmece	YxGxD / mm	kg	FİYAT/TL
A01-06	6	975x710x450	60	
A01-07	7	975x710x450	62	
A01-08	8	975x710x450	72	

A01-W Serisi

GT-PLUS XL Takım Arabaları (Boş) - 6 Çekmeceli



A01-06W: PVC kaplı metal tezgahlı
A01-06WW: Ahşap tezgahlı

KOD NO	Çekmece	YxGxD / mm	kg	FİYAT/TL
A01-06W	6	997x1085x450	74	
A01-06WW	6	997x1085x450	82	

A01M-J Serisi

GT-MAX Jumbo Takım Arabaları (Boş)



Geniş Gövde

KOD NO	Çekmece	YxGxD / mm	kg	FİYAT/TL
A01M-07J	7	1018x922x458	77	
A01M-08J	8	1018x922x458	80	

A01-J Serisi

GT PLUS Jumbo Takım Arabaları (Boş)



Geniş Gövde

KOD NO	Çekmece	YxGxD / mm	kg	FİYAT/TL
A01-07J	7	975x890x450	72	
A01-08J	8	975x890x450	74	

A01-11 Serisi

GT PLUS Jumbo XL Takım Arabaları (Boş) - 11 Çekmeceli



A01-11: PVC kaplı metal tezgahlı
A01-11W: Ahşap tezgahlı

KOD NO	Çekmece	YxGxD / mm	kg	FİYAT/TL
A01-11	11	1020x1085x500	90	
A01-11W	11	1020x1085x500	97	

A02 Serisi

GT Takım Arabaları (Boş)



KOD NO	Çekmece	YxGxD / mm	kg	FİYAT/TL
A02-04*	3	825x630x450	38	
A02-05	5	825x630x450	47	
A02-06	6	825x630x450	49	

* A02-04 büyük parçalar için kilitleti entegre bir dolap bölümü ile sunulur

A03-SD

Servis Arabası (Standart)



KOD NO	YxGxD / mm	kg	FİYAT/TL
A03-SD	930 x 760 x 460	29	

A03-ID

Servis Arabası (Ağır Hizmet)



KOD NO	YxGxD / mm	kg	FİYAT/TL
A03-ID	950 x 910 x 560	35	

A17L-NW

Çalışma Masası (Ahşap Tezgâhli)



KOD NO	YxGxD / mm	kg	FİYAT/TL
A17L-NW	950 x 1700 x 700	45	

A17L-NS

Çalışma Masası (Paslanmaz Çelik Tezgâhli)



KOD NO	YxGxD / mm	kg	FİYAT/TL
A17L-NS	950 x 1700 x 700	59	

A17L-NG

Çalışma Masası (Galvanize Çelik Tezgâhli)



KOD NO	YxGxD / mm	kg	FİYAT/TL
A17L-NG	950 x 1700 x 700	64	

A17D Serisi

Çalışma Masaları - 3 Çekmeceli

Y x G x D (mm)
950 x 1700 x 700

KOD NO	TEZGÂH	kg	FİYAT/TL
A17D-W	Ahşap	69	
A17D-S	Paslanmaz Çelik	84	
A17D-G	Galvanize Çelik	89	

A17D-P Serisi

Çalışma Masaları (Panolu) - 3 Çekmeceli

Y x G x D (mm)
950 x 1700 x 730

KOD NO	TEZGÂH	kg	FİYAT/TL
A17D-WP	Ahşap	88	
A17D-SP	Paslanmaz Çelik	103	
A17D-GP	Galvanize Çelik	108	

Pano bölümünü tek olarak sipariş etmek için A20-170 kodunu kullanınız

A20-200SH

Panjurlu Alet Panosu (Boş) - L



KOD NO	GxYxD / mm	kg	FİYAT/TL
A20-200SH	2000 x 900 x 215	51	

1 Takım Arabaları ve Alet Setleri

A20-110SH

Panjurlu Alet Panosu (Boş) - M



KOD NO	GxYxD / mm	kg	FİYAT/TL
A20-110SH	1140 x 900 x 215	30	

A20 Serisi Alet Panoları

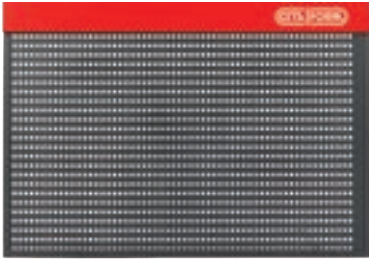

KOD NO	GxY / mm	kg	FİYAT/TL
A20-100	1000 x 700	9	
A20-170	1700 x 900	19	

A20-170 ayrıca A17L Serisi çalışma tezgâhlarına uyumludur

A01-PS

GT-PLUS Serisi için Alet Panosu

- GT-PLUS dolaplar (A01-06, 07, 08) ile uyumludur
- Kancasız teslim edilir



KOD NO	YxG / mm	kg	FİYAT/TL
A01-PS	600 x 620	5.0	

A01-PM

GT-PLUS Jumbo Serisi için Alet Panosu

- GT-PLUS Jumbo dolaplar (A01-07J, 08J) ile uyumludur
- Kancasız teslim edilir

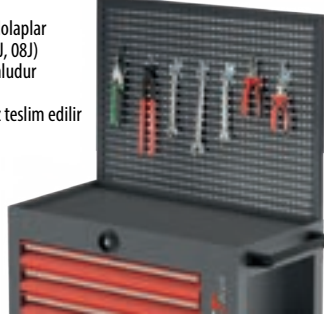

KOD NO	YxG / mm	kg	FİYAT/TL
A01-PM	600 x 796	6.5	

A01-PL

GT-PLUS XL Serisi için Alet Panosu

- GT-PLUS XL dolaplar (A01-06W, 06WW, A01-11, 11W) ile uyumludur
- Kancasız teslim edilir



KOD NO	YxG / mm	kg	FİYAT/TL
A01-PL	600 x 1128	7.7	

A17H Serisi

Kancalar (Alet Panoları için)

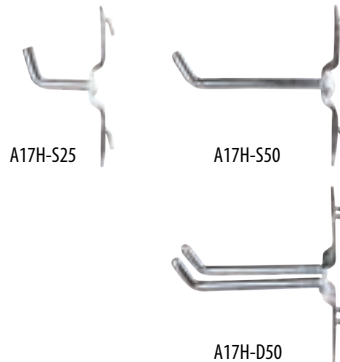

KOD NO	L / mm	kg	FİYAT/TL
A17H-S25	25	12 •	
A17H-S50	50	12 •	
A17H-D50	50	12 •	

A01M-LD

GT-MAX Serisi için Yan Kapak (Kilitli)

- GT-MAX ve GT-MAX Jumbo Serisi (A01M-06,07,08 ve A01M-07J, 08J) takım arabalarının sağ panel yuvasına entegre edilebilir
- 95 mm net derinlik ve yaklaşık 750 mm kullanılabilir yükseklik



KOD NO	kg	FİYAT/TL
A01M-LD	1	

A01M-CH

GT-MAX Serisi için Sprey Tutucu

- GT-MAX ve GT-MAX Jumbo Serisi (A01M-06,07,08 ve A01M-07J, 08J) takım arabalarının sağ panel yuvasına entegre edilebilir



KOD NO	kg	FİYAT/TL
A01M-CH	1	

A01M-PR

GT-MAX Serisi için Rulo Kağıt Havlu Tutucu

- GT-MAX ve GT-MAX Jumbo Serisi (A01M-06,07,08 ve A01M-07J, 08J) takım arabalarının sağ panel yuvasına entegre edilebilir
- Kağıt havlu dahil değildir



KOD NO	kg	FİYAT/TL
A01M-PR	1	

A01M-DH

GT-MAX Serisi için Doküman Gözü

- GT-MAX ve GT-MAX Jumbo Serisi (A01M-06,07,08 ve A01M-07J, 08J) takım arabalarının sağ panel yuvasına entegre edilebilir
- A4 ölçüsündeki dokümanlar için uygundur



KOD NO	KULLANIM	FİYAT/TL
A01M-DH	1	

A01-PM Serisi

PVC Mat (Takım Arabaları Çalışma Yüzeyleri için)

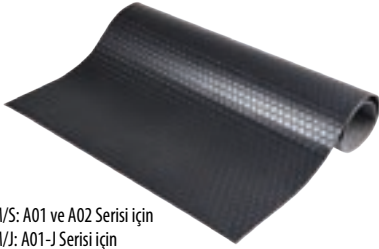

A01-PM/S: A01 ve A02 Serisi için
 A01-PM/J: A01-J Serisi için
 A01-PM/W: A01-W Serisi için
 A01-PM/XL: A01-11 Serisi için

KOD NO	YxG / mm	FİYAT/TL
A01-PM/S	445 x 625	1
A01-PM/J	445 x 800	1
A01-PM/W	445 x 1080	1
A01-PM/XL	495 x 1080	1

A-SL

Kilit Mekanizması



KOD NO	KULLANIM	FİYAT/TL
A-SL	GT-MAX, GT-PLUS, GT Serisi	1

A-SH

Tutma Kolu (Takım Arabaları için)



KOD NO	KULLANIM	FİYAT/TL
A-SH	GT-MAX, GT-PLUS, GT Serisi	1

A-STR-4045

Teleskopik Ray Takımı

yeni

KOD NO	LxG / mm	FİYAT/TL
A-STR-4045	400 x 45	1

A-SW100 Serisi

Tekerlekler - Ø 100 (GT Serisi ve A03-SD için)

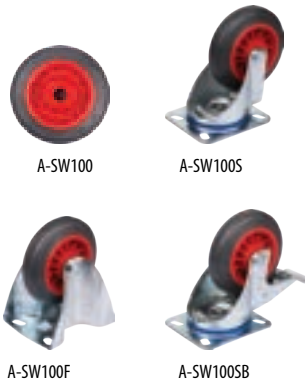

KOD NO	TİP	Ø / mm	FİYAT/TL
A-SW100	Sadece Tekerlek	100	1
A-SW100F	Sabit	100	1
A-SW100S	Döner	100	1
A-SW100SB	Frenli - Döner	100	1

A-SWS-01M

Üst Tabla (GT-MAX Serisi için)



KOD NO	YxGxD / mm	FİYAT/TL
A-SWS-01M	35 x 745 x 455	1

A-SWJ-01M

Üst Tabla (GT-MAX Jumbo Serisi için)



KOD NO	YxGxD / mm	FİYAT/TL
A-SWJ-01M	35 x 920 x 455	1

A-SW125 Serisi

(GT-MAX, GT-PLUS Serileri ve A03-ID için)



KOD NO	TİP	Ø / mm	FİYAT/TL
A-SW125	Sadece Tekerlek	125	1
A-SW125F	Sabit	125	1
A-SW125S	Döner	125	1
A-SW125SB	Frenli - Döner	125	1

1 Takım Arabaları ve Alet Setleri

A06-04

Takım Sandığı (Boş) - 4 Çekmeceli



KOD NO	Çekmece	YxGxD / mm	kg	FİYAT/TL
A06-04	4	492 x 625 x 442	35	

A06-04JS

Jumbo Takım Sandığı (Boş) - 4 Çekmeceli



KOD NO	Çekmece	YxGxD / mm	kg	FİYAT/TL
A06-04JS	4	492 x 800 x 442	42	

A06-08JX

Jumbo XL Takım Sandığı (Boş) - 8 Çekmeceli



KOD NO	Çekmece	YxGxD / mm	kg	FİYAT/TL
A06-08JX	8	492 x 1075 x 442	64	

A06-CT

Taşıma Arabası (Takım Sandıkları için)



KOD NO	YxGxD / mm	kg	FİYAT/TL
A06-CT	165 x 810 x 450	12	

A07-02

Portatif Takım Sandığı (Boş) - 2 Çekmeceli



KOD NO	Çekmece	YxGxD / mm	kg	FİYAT/TL
A07-02	2	250 x 565 x 255	11	

A07-03

Portatif Takım Sandığı (Boş) - 3 Çekmeceli



KOD NO	Çekmece	YxGxD / mm	kg	FİYAT/TL
A07-03	3	300 x 565 x 255	11.5	

A07-0301

Havacılık Takım Sandığı (Boş) - 3 Çekmeceli



KOD NO	Çekmece	YxGxD / mm	kg	FİYAT/TL
A07-0301	3	310 x 560 x 230	14	

A25-5 Serisi

5 Gözlü Metal Takım Çantaları



KOD NO	GÖZ SAYISI	GxYxD / mm	kg	FİYAT/TL
A25-5	5	420 x 195 x 200	4.3	
A25-5L	5	510 x 195 x 200	5.2	

A27-PL Serisi

Plastik Takım Çantaları



KOD NO	GxYxD / mm	kg	FİYAT/TL
A27-16PL	434 x 239 x 194	8 •	
A27-19PL	494 x 263 x 250	8 •	
A27-22PL	582 x 310 x 293	6 •	

A27J-28

Portatif Tekerlekli Takım Çantası

yeni

KOD NO	GxYxD / mm	kg	FİYAT/TL
A27J-28	595 x 420 x 380	5.0	

A32

Raptor Takım Çantası



KOD NO	GxYxD / mm	kg	FİYAT/TL
A32	530 x 400 x 180	5.0	

A32H

Raptor Takım Çantası (Çekçekli)



KOD NO	GxYxD / mm	kg	FİYAT/TL
A32H	530 x 400 x 230	6.3	

A32/T

A32 Raptor Takım Çantası için Çekçek



A32 için

KOD NO	GxYxD / mm	kg	FİYAT/TL
A32/T	320 x 490 / 920 x 70	1.3	

A26-ET01

Teknisyen Takım Çantası - Plus



KOD NO	GxYxD / mm	kg	FİYAT/TL
A26-ET01	440 x 340 x 200	2.0	

A26-IT01

Teknisyen Takım Çantası - Tech



KOD NO	GxYxD / mm	kg	FİYAT/TL
A26-IT01	460 x 340 x 150	1.9	

A26-BP01

Teknisyen Sırt Çantası



KOD NO	GxYxD / mm	kg	FİYAT/TL
A26-BP01	355 x 460 x 225	1.2	

A26-TB Serisi

Alet Çantaları - Basic



A26-TB12



A26-TB19

KOD NO	GxYxD / mm	kg	FİYAT/TL
A26-TB12	300 x 190 x 150	0.46	
A26-TB19	500 x 280 x 260	1.60	

A26-PB01

Kompakt Bel Çantası

yeni

KOD NO	GxY / mm	kg	FİYAT/TL
A26-PB01	170x330	0.15	

1 Takım Arabaları ve Alet Setleri

A50M-98A07

98 Parça Mekanikçi Alet Seti



KOD NO	FİYAT/TL	GxYxD (mm)
A50M-98A07		300 x 565 x 255

İÇERİK

B01	12 PC: 6, 7, 8, 9, 10, 11, 12, 13, 14, 17, 19, 22 mm Kombine Anahtar
LT/900	9 PC: 1.5, 2, 2.5, 3, 4, 5, 6, 8, 10 mm Topbaşlı L Allen Anahtar Takımı (Uzun Tip)
LT/700L	8 PC: T9, T10, T15, T20, T25, T27, T30, T40 TORX L Anahtar Takımı (Uzun Tip)
C02-H	12 PC: 4, 5, 5.5, 6, 7, 8, 9, 10, 11, 12, 13, 14 mm 1/4" 6 Köşe Lokma Anahtar
C22-H	18 PC: 8, 10, 11, 12, 13, 14, 15, 16, 17, 18, 19, 20, 21, 22, 24, 27, 30, 32 mm 1/2" 6 Köşe Lokma Anahtar
C01-12	1/4" Düğmeli Cırcır Kolu
C21-12	1/2" Düğmeli Cırcır Kolu
C01-20	1/4" Lokma Tornavidası (120 mm)
C01-40	1/4" T Kol (115 mm)
C21-40	1/2" T Kol (250 mm)
C01-70	2 PC: 50, 100 mm 1/4" Uzatma Kolu
C21-70	2 PC: 125, 250 mm 1/2" Uzatma Kolu
C01-80	1/4" Üniversal Mafsallı
C21-80	1/2" Üniversal Mafsallı
F10	4 PC: 3.0x75, 4.0x100, 5.5x125, 6.5x150 mm C-PLUS Düz Uçlu Tornavida
F10/TP	5.5 x 25 mm C-PLUS Topaç Düz Uçlu Tornavida
F14	2 PC: PH1x80, PH2x100 mm C-PLUS Yıldız Uçlu Tornavida
F14/TP	PH2 x 25 mm C-PLUS Topaç Yıldız Uçlu Tornavida
6105CP	16 PC: 3 mm C-PLUS Kontrol Kalem (VDE-Küçük)
E01-41	180 mm Kombine Pense
E06-41	160 mm Yan Keski
E15-41	160 mm Kargaburun
E30-54	250 mm Papağan Pense (Kutu Mafsallı)
E50-240-2	240 mm Üniversal Ayarlı Pense
J45CPM	C-Pro Maket Bıçağı (Metal Gövde) - 18 mm
L01-500	Tesviyeci Çekiç - 500 gr
L12-40	Plastik Kafalı Çekiç - Ø 40 mm
L25-150-2	Düz Keski - 18 x 150 mm
L29-4	Nokta Zımba - Ø4 x 120 mm
L31	4 PC: Ø(3, 4, 5, 6) x 150 mm Düz Pim Zımba
P05-0519	Compact Şerit Metre (5 M x 19 mm)
P15	2 PC: Paslanmaz Çelik Cetvel - 15, 30 cm
P54-20S	Filler Çakısı (Metrik - 20 Yaprak) (0.05 - 1.0 mm)
R11-PEN	Lu-MAX Kalem Tipi LED Cep Feneri - 100 Lümen

A50AS-159A07

159 Parça Havacılık Alet Seti



KOD NO	FİYAT/TL	GxYxD (mm)
A50AS-159A07		310 x 560 x 230

İÇERİK

B01AS	7/32 inch Kombine Anahtar (Kısa Tip-12 Köşe) - SAE
B01A	15 PC: 1/4, 9/32, 5/16, 11/32, 3/8, 7/16, 1/2, 9/16, 5/8, 11/16, 3/4, 13/16, 7/8, 15/16, 1 inch Kombine Anahtar - SAE
B09SA	9 PC: 7/32, 15/64, 1/4, 9/32, 5/16, 11/32, 3/8, 7/16, 1/2 inch Açılı Ağız Ağız Anahtar (Kısa Tip) - SAE
B07A	3 PC: 1/4x5/16, 3/8x7/16, 1/2x9/16 inch Cırcırlı Yıldız Anahtar (Düz) - SAE
B21-B	2 PC: 150, 250 mm Kurbağacık Anahtar
K99-F2M	9 PC: 0.05, 1/16, 5/64, 3/32, 7/64, 1/8, 9/64, 5/32, 3/16 inch Çıku Tipi Allen Anahtar Seti (Metal Kasa) - SAE
C02A-B	10 PC: 3/16, 7/32, 1/4, 9/32, 5/16, 11/32, 3/8, 7/16, 1/2, 9/16 inch 1/4" 12 Köşe (Yıldız) Lokma Anahtar - SAE
C04A-B	10 PC: 3/16, 7/32, 1/4, 9/32, 5/16, 11/32, 3/8, 7/16, 1/2, 9/16 inch 1/4" 12 Köşe (Yıldız) Derin Lokma Anahtar - SAE
C02UA	9 PC: 7/32, 1/4, 9/32, 5/16, 11/32, 3/8, 7/16, 1/2, 9/16 inch 1/4" 12 Köşe (Yıldız) Mafsallı Lokma Anahtar - SAE
C08AS-H	11 PC: 1/16, 5/64, 3/32, 7/64, 1/8, 9/64, 5/32, 3/16, 7/32, 1/4, 5/16 inch 1/4" Allen Uçlu Lokma - SAE
C01-T90	1/4" Kapalı Tip Cırcır Kolu (Metal Saplı)
C01-70	4 PC: 50, 75, 100, 150 mm 1/4" Uzatma Kolu
C01-75F	1/4" Bükülebilir Uzatma Kolu (150 mm)
C01-92	1/4" Lokma Adaptörü - D: 1/4" < E: 3/8"
C12A-B	13 PC: 1/4, 5/16, 3/8, 7/16, 1/2, 9/16, 5/8, 11/16, 3/4, 13/16, 7/8, 15/16, 1 inch 3/8" 12 Köşe (Yıldız) Lokma Anahtar - SAE
C14A-B	13 PC: 1/4, 5/16, 3/8, 7/16, 1/2, 9/16, 5/8, 11/16, 3/4, 13/16, 7/8, 15/16, 1 inch 3/8" 12 Köşe (Yıldız) Derin Lokma Anahtar - SAE
C11-T90	3/8" Kapalı Tip Cırcır Kolu (Metal Saplı)
C11-36MR	3/8" Mafsallı Kol (Metal Saplı) - 250 mm
C11-70	3 PC: 75, 150, 250 mm 3/8" Uzatma Kolu
C11-50MR	3/8" Firdöndü Kol (Metal Avuç Saplı) - 420 mm
C11-80	3/8" Üniversal Mafsallı
C11-91	3/8" Lokma Adaptörü - D: 3/8" > E: 1/4"
BT/8003	3/8" Bits Tutucu Lokma
F10	2 PC: 5.5x125, 8.0x150 mm C-PLUS Düz Uçlu Tornavida
F14	PH2x100 mm C-PLUS Yıldız Uçlu Tornavida
3100/TF2	PH2/6.0 x 175 mm Değişken Uçlu Tornavida
Z/12	PH1/PH2 x 100 mm Yıldız Uçlu Z Tornavida
Z/55	5.5/5.5 x 100 mm Düz Uçlu Z Tornavida
F26/RDS	12-in-1: Cırcırlı Topaç Bits Tornavidası
F26/BR2	Bits Cırcır Kolu No.2 - 1/4" x 90 mm
E01-44	180 mm Kombine Pense
E06-44	160 mm Yan Keski
E15-44	160 mm Kargaburun
E50-2	2 PC: 140, 240 mm Üniversal Ayarlı Pense
E30-54	250 mm Papağan Pense (Kutu Mafsallı)
E80-230R	Tel Bükme Pensesi (Cırcırlı) - 230 mm
L02-12	Bombe Başlı Çekiç - 12 Oz/340 gr
L12-40	Plastik Kafalı Çekiç - Ø 40 mm
L35A-51	5 PC: Keski ve Zımba Takımı - SAE
R.P6	Lumax PRO 2AA El Feneri (Focus)
R15-1000	Mıknatıslı Parça Yakalama (Spiral Şaftlı) - Kap.:1000 gr
R16-700	Makinist Parmağı (Mıknatıslı) (Kap.: 500 gr)
R20R	Teleskopik Yuvarlak Ayna - Ø 50 -25/90cm
R36-1	Düz Uçlu Biz

A50M-43

43 Parça Mekanikçi Alet Seti



43 Parça Mekanikçi Alet Seti

43 Parça Mekanikçi Alet Seti (Takım Çantaları ile)

Sadece içerik



(A50M-43+A25-5L)



(A50M-43+A27-19PL)



(A50M-43+A32)



(A50M-43+A32H)



KOD NO A50M-43

A50M-43A25

A50M-43A27

A50M-43A32

A50M-43A32H

FİYAT/TL

A50M-80PH4

80 Parça Universal Alet Seti



KOD NO

PARÇA

GxYxD / mm

FİYAT/TL

A50M-80PH4

80

440x320x100

1 Takım Arabaları ve Alet Setleri

CFS

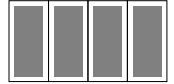

700x370 mm

B99-E41T

41 Parça Anahtar Seti

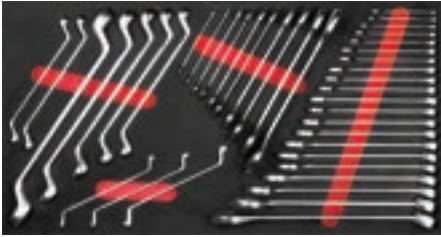

KOD NO	PARÇA SAYISI	FİYAT/ TL
B99-E41T	41	

B01	21 PC: 6, 7, 8, 9, 10, 11, 12, 13, 14, 15, 16, 17, 18, 19, 20, 21, 22, 24, 27, 30, 32 mm Kombine Anahtar
B10	10 PC: 6x7, 8x9, 10x11, 12x13, 14x15, 16x17, 18x19, 20x22, 24x27, 30x32 mm Çatal İki Ağız Anahtar (Kısa Tip)
B14	10 PC: 6x7, 8x9, 10x11, 12x13, 14x15, 16x17, 18x19, 20x22, 24x27, 30x32 mm Yıldız İki Ağız Anahtar

CF-E105

105 Parça Tornavida ve 1/2" Lokmalı Bits Seti



KOD NO	PARÇA SAYISI	FİYAT/ TL
CF-E105	105	

F10	4 PC: 3.0x75, 4.0x100, 5.5x125, 6.5x150 mm C-PLUS Düz Uçlu Tornavida
F14	2 PC: PH1x80, PH2x100 mm C-PLUS Yıldız Uçlu Tornavida
F10/TP	1 PC: 5.5 x 25 mm C-PLUS Topaç Düz Uçlu Tornavida
F14/TP	1 PC: PH2 x 25 mm C-PLUS Topaç Yıldız Uçlu Tornavida
F18	7 PC: T10x80, T15x80, T20x100, T25x100, T27x115, T30x115, T40x130 C-PLUS TORX Uçlu Tornavida
F26/BT	Bits Tutucu Tornavida - 1/4" x 100 mm
CB/ST31	31 PC: Bits Uç Takımı
F26/RDS	12-in-1: Cırcırlı Topaç Bits Tornavidası
F26/BR2	Bits Cırcır Kolu No.2 - 1/4" x 90 mm
6105CP	C-PLUS Kontrol Kalem (VDE-Küçük)
G09-11	Oto Elektrik Kontrol Kalem - 6/24 DC (V)
LT/900	9 PC: 1.5, 2, 2.5, 3, 4, 5, 6, 8, 10 mm Topbaşlı L Allen Anahtar Takımı (Uzun Tip)
LT/700L	8 PC: T9, T10, T15, T20, T25, T27, T30, T40 TORX L Anahtar Takımı (Uzun Tip)
C285-H	7 PC: (5, 6, 7, 8, 10, 12, 14) 1/2" Allen Uçlu Lokma - Kısa Tip
C285-T	9 PC: (T20, T25, T27, T30, T40, T45, T50, T55, T60) x 55mm 1/2" TORX Uçlu Lokma - Kısa Tip
C285-TL	4 PC: (T30, T40, T45, T50) 1/2" TORX Uçlu Lokma - Uzun Tip
C285-XL	3 PC: (M6, M8, M14) x 100 mm 1/2" XZN Uçlu Lokma - Uzun Tip
C285-XXL	2 PC: (M10, M12) 1/2" XZN Uçlu Lokma - Ekstra Uzun Tip
C285-X16	1 PC: M16 x 55 mm 1/2" XZN Uçlu Lokma - Kısa Tip

F99-E95

95 Parça Tornavida ve L/T Anahtar Seti



KOD NO	PARÇA SAYISI	FİYAT/ TL
F99-E95	95	

F10	4 PC: 3x75, 4x100, 5.5x125, 6.5x150 mm C-PLUS Düz Uçlu Tornavida
F14	2 PC: PH1x80, PH2x100 mm C-PLUS Yıldız Uçlu Tornavida
F10/TP	1 PC: 5.5x25 mm C-PLUS Topaç Düz Uçlu Tornavida
F14/TP	1 PC: PH2x25 mm C-PLUS Topaç Yıldız Uçlu Tornavida
F18	7 PC: T10x80, T15x80, T20x100, T25x100, T27x115, T30x115, T40x130 mm C-PLUS TORX Uçlu Tornavida
F20	5 PC: (6, 7, 8, 10, 13)x125 mm C-PLUS Lokma Uçlu Tornavida
H01	4 PC: 1.5x40, 2x60, 2.5x80, 3x80 mm Düz Uçlu Elektronik Tornavida
H02	2 PC: PH00x60, PH0x60 mm Yıldız Uçlu Elektronik Tornavida
K10	6 PC: 2x100, 2.5x100, 3x100, 4x150, 5x150, 6x200 mm T Saplı Allen Anahtar
LT/900	9 PC: 1.5, 2, 2.5, 3, 4, 5, 6, 8, 10 mm Topbaşlı L Allen Anahtar Takımı (Uzun Tip)
LT/700L	8 PC: T9, T10, T15, T20, T25, T27, T30, T40 TORX L Anahtar Takımı (Uzun Tip)
F26/BT	C-PLUS Bits Tutucu Tornavida - 1/4" x 100 mm
CB/ST31	31 PC: Bits Uç Takımı
F26/RDS	12-in-1: Cırcırlı Topaç Bits Tornavidası
F26/BR2	Bits Cırcır Kolu No.2 - 1/4" x 90 mm
6105CP	C-PLUS Kontrol Kalem (VDE-Küçük)

EL-E34

34 Parça Alet Seti

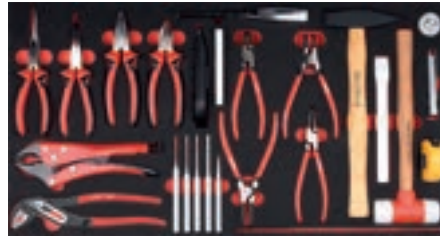

KOD NO	PARÇA SAYISI	FİYAT/ TL
EL-E34	34	

E01-41	180 mm Kombine Pense
E06-41	160 mm Yan Keski
E15-41	200 mm Kargaburun
E16-41	200 mm Eğri Kargaburun
E30-54	250 mm Papagan Pense (Kutu Mafsal)
E50-2	240 mm Üniversal Ayarlı Pense
E65-44	180 mm Dış Segman Pensesi (Düz Uçlu-Yaylı)
E66-44	180 mm Dış Segman Pensesi (Eğri Uçlu-Yaylı)
E67-44	180 mm İç Segman Pensesi (Düz Uçlu)
E68-44	180 mm İç Segman Pensesi (Eğri Uçlu)
N12-10	Hortum Kelepçe Pensesi (Yaylı Kelepçeler için)
J45CPM	C-Pro Maket Bıçağı (Metal Gövde) - 18 mm
J45-R	10 PC: 18 mm Maket Bıçağı Yedeği
L01-500	Tesviyeci Çekiçi - 500 gr
L12-40	Plastik Kafalı Çekiçi - Ø40 mm
L12-R40	Yedek Plastik Kafa (L12-40 için) - Tek
L25-200-2	Düz Keski - 24x 200 mm
L29-4	Nokta Zimba - Ø4 x 120 mm
L31	4 PC: Ø(3, 4, 5, 6) x 150 mm Düz Pim Zimba
P05-0519	Compact Şerit Metre (5 M x 19 mm)
P15-030	Paslanmaz Çelik Cetvel - 30 cm
P54-205	Filler Çakısı (Metrik - 20 Yaprak) (0.05 - 1.0 mm)

JLR-E62

62 Parça Alet Seti



KOD NO	PARÇA SAYISI	FİYAT/ TL
JLR-E62	62	

J55-108H	Standart Eğe (Kalın) - 20 x 200 mm
J56-108H	Yarım Yuvarlak Eğe (Kalın) - 20 x 200 mm
J57-108H	Yuvarlak Eğe (Kalın) - Ø7.5 x 200 mm
J58-108H	Kare Eğe (Kalın) - 8 x 200 mm
J59-108H	Üçgen Eğe (Kalın) - 15 x 200 mm
J75-R06	6 PC: Saatçi Eğe Takımı
J45CPM	C-Pro Maket Bıçağı (Metal Gövde) - 18 mm
J45-R	10 PC: 18 mm Maket Bıçağı Yedeği
L01-500	Tesviyeci Çekiçi - 500 gr
L12-40	Plastik Kafalı Çekiçi - Ø 40 mm
L12-R40	Yedek Plastik Kafa (L12-40 için) - Tek
L25-200-2	Düz Keski - 24x 200 mm
L29-4	Nokta Zimba - Ø4 x 120 mm
L31	4 PC: Ø(3, 4, 5, 6) x 150 mm Düz Pim Zimba
P05-0519	Compact Şerit Metre (5 M x 19 mm)
P15-030	Paslanmaz Çelik Cetvel - 30 cm
P54-205	Filler Çakısı (Metrik - 20 Yaprak) (0.05 - 1.0 mm)
R11-PEN	Kalem Tipi LED Cep Feneri - 100 lümen
R15-1000	Mıknatıslı Parça Yakalama (Kap: 1000 gr) - 400 mm
A205210	19 PC: 1, 1.5, 2, 2.5, 3, 3.5, 4, 4.5, 5, 5.5, 6, 6.5, 7, 7.5, 8, 8.5, 9, 9.5, 10 mm HSS Matkap Ucu Takımı
R35CT	Karbür Uçlu Metal Çizecek - 145 mm
R36 Serisi	4 PC: Düz Uçlu, Açılı Uçlu, 90° Uçlu, Kanca Uçlu Bizler
R37-25	Conta Kazıma Aleti - 25 x 150 mm
R40-4	Plastik Saplı Tel Fırça (4 Sıra Telli) - 275 mm

KNR-E37

37 Parça Alet Seti

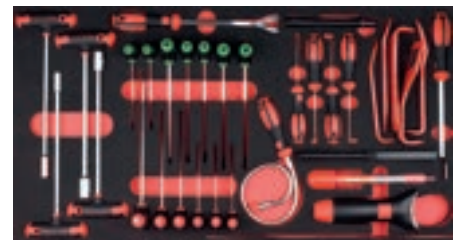

KOD NO	PARÇA SAYISI	FİYAT/ TL
KNR-E37	37	

K20	4 PC: (7, 8, 10, 13)x125 mm T Saplı Lokma Anahtar
K10	6 PC: 2x100, 2.5x100, 3x100, 4x150, 5x150, 6x200mm T Saplı Allen Anahtar
K12	7 PC: T10x100, T15x100, T20x150, T25x150, T27x150, T30x150, T40x150 mm T Saplı TORX Anahtar
N12-05	Antifriz Bomesi - 200 mm
N14-0615	Metal Bantlı Yağ Filtre Anahtar - Ø 60-100 mm
N14-06R	4 PC: Yedek Metal Bant (N14-06 Serisi için)
N21-10	Fren Kaliperi Fırçası - 220 mm
N31-1105	5 PC: Döşeme ve Trim Sökme Takımı
N31-12	Döşeme Klips Sökme Aleti - 150 mm
R11-PEN	Kalem Tipi LED Cep Feneri - 100 lümen
R15-1000	Mıknatıslı Parça Yakalama (Kap: 1000 gr) - 400 mm
R36 Serisi	4 PC: Düz Uçlu, Açılı Uçlu, 90° Uçlu, Kanca Uçlu Bizler
R37-25	Conta Kazıma Aleti - 25 x 150 mm

**B01-E21/2**

21 Parça Kombine Anahtar Takımı

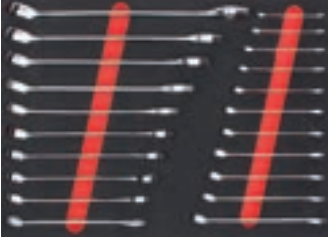
Yeni

KOD NO	PARÇA SAYISI	FİYAT/ TL
B01-E21/2	21	

B01 21 PC: 6, 7, 8, 9, 10, 11, 12, 13, 14, 15, 16, 17, 18, 19, 20, 21, 22, 24, 27, 30, 32 mm Kombine Anahtar

B99-E24T

24 Parça Kombine ve Çatal İki Ağz Anahtar Seti

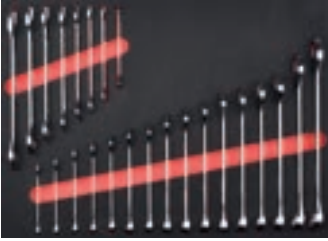

KOD NO	PARÇA SAYISI	FİYAT/ TL
B99-E24T	24	

B01 16 PC: 6, 7, 8, 9, 10, 11, 12, 13, 14, 15, 16, 17, 18, 19, 22, 24 mm Kombine Anahtar
B10 8 PC: 6x7, 8x9, 10x11, 12x13, 14x15, 16x17, 18x19, 20x22 mm Çatal İki Ağz Anahtar (Kısa Tip)

B99-E241

24 Parça Kombine ve Yıldız İki Ağz Anahtar Seti

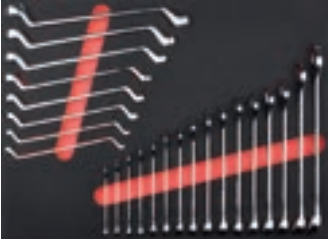

KOD NO	PARÇA SAYISI	FİYAT/ TL
B99-E241	24	

B01 16 PC: 6, 7, 8, 9, 10, 11, 12, 13, 14, 15, 16, 17, 18, 19, 22, 24 mm Kombine Anahtar
B14 8 PC: 6x7, 8x9, 10x11, 12x13, 14x15, 16x17, 18x19, 20x22 mm Yıldız İki Ağz Anahtar

B99-E32T

32 Parça Anahtar Seti

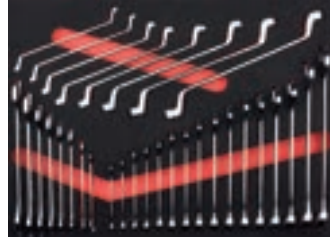

KOD NO	PARÇA SAYISI	FİYAT/ TL
B99-E32T	32	

B01 16 PC: 6, 7, 8, 9, 10, 11, 12, 13, 14, 15, 16, 17, 18, 19, 22, 24 mm Kombine Anahtar
B10 8 PC: 6x7, 8x9, 10x11, 12x13, 14x15, 16x17, 18x19, 20x22 mm Çatal İki Ağz Anahtar (Kısa Tip)
B14 8 PC: 6x7, 8x9, 10x11, 12x13, 14x15, 16x17, 18x19, 20x22 mm Yıldız İki Ağz Anahtar

B99A-E26

26 Parça Kombine ve Çatal İki Ağz Anahtar Seti - SAE

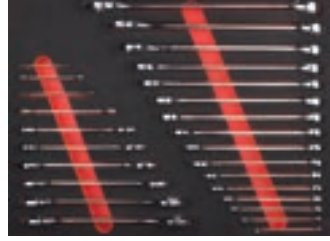

KOD NO	PARÇA SAYISI	FİYAT/ TL
B99A-E26	26	

B01A 16 PC: 1/4, 5/16, 3/8, 7/16, 1/2, 9/16, 5/8, 11/16, 3/4, 13/16, 7/8, 15/16, 1, 1 1/16, 1 1/8, 1 1/4 inch Kombine Anahtar - SAE
B09A 10 PC: 1/4x5/16, 5/16x3/8, 7/16x1/2, 1/2x9/16, 9/16x5/8, 5/8x3/4, 11/16x3/4, 13/16x7/8, 15/16x1, 1-1/16x1-1/8 inch Çatal İki Ağz Anahtar - SAE

B99A-E31

31 Parça Anahtar Seti - SAE



KOD NO	PARÇA SAYISI	FİYAT/ TL
B99A-E31	31	

B01AS 7/32 inch Kombine Anahtar (Kısa Tip-12 Köşe) - SAE
B01A 15 PC: 1/4, 9/32, 5/16, 11/32, 3/8, 7/16, 1/2, 9/16, 5/8, 11/16, 3/4, 13/16, 7/8, 15/16, 1 inch Kombine Anahtar - SAE
B07A 4 PC: 1/4x5/16, 5/16x11/32, 3/8x7/16, 1/2x9/16 inch Cırcırlı Yıldız Anahtar (Düz) - SAE
B09SA 9 PC: 7/32, 15/64, 1/4, 9/32, 5/16, 11/32, 3/8, 7/16, 1/2 inch Açılı Açık Ağz Anahtar (Kısa Tip) - SAE
B21-B 2 PC: 150, 250 mm Kurbağacık Anahtar (Fosfat Kaplı)

BC-E08

8 Parça Alet Seti



KOD NO	PARÇA SAYISI	FİYAT/ TL
BC-E08	8	

B01 3 PC: 27, 30, 32 mm Kombine Anahtar
B14 2 PC: 24x27, 30x32 mm Yıldız İki Ağz Anahtar
C21-79W 1/2" Uzatma Kolu (Bombe Başlı) - 500 mm
C31-40 3/4" T Kol - 500 mm
N23-0750 Lastik Levyesi - (500 mm : 20")

BC-E081

8 Parça Alet Seti



KOD NO	PARÇA SAYISI	FİYAT/ TL
BC-E081	8	

B01 3 PC: 27, 30, 32 mm Kombine Anahtar
B14 2 PC: 21x23, 24x26 mm Yıldız İki Ağz Anahtar
C21-79W 1/2" Uzatma Kolu (Bombe Başlı) - 500 mm
C31-40 3/4" T Kol - 500 mm
N23-0750 Lastik Levyesi - (500 mm : 20")



1 Takım Arabaları ve Alet Setleri

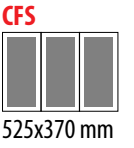

BC-E40

40 Parça C-GEAR Cırcırlı Kombine Anahtar ve 1/2" Lokmal Bits Seti



KOD NO	PARÇA SAYISI	FİYAT/TL
BC-E40	40	
B05	6 PC: 8, 10, 12, 13, 17, 19 mm C-GEAR Cırcırlı Kombine Anahtar (Düz)	
B19	10x11 mm Rakor Anahtar	
C28S-T	8 PC: (T25, T27, T30, T40, T45, T50, T55, T60) x 55 mm 1/2" TORX Uçlu Lokma - Kısa Tip	
C28S-H	9 PC: (5, 6, 7, 8, 10, 12, 14, 17, 19) x 55 mm 1/2" Allen Uçlu Lokma - Kısa Tip	
C28S-HBXL	4 PC: (6, 7, 8, 10 mm) x 140 mm 1/2" Topbaşı Allen Uçlu Lokma - Ekstra Uzun Tip	
C28S-X	7 PC: (M5, M6, M8, M10, M12, M14, M16) x 55 mm 1/2" XZN Uçlu Lokma - Kısa Tip	
C28S-XL	2 PC: (M8, M14) x 100 mm 1/2" XZN Uçlu Lokma - Uzun Tip	
C28S-XXL	2 PC: (M10, M12) x 140 mm 1/2" XZN Uçlu Lokma - Ekstra Uzun Tip	
C68-X18	M18 x 78 mm 1/2" XZN Uçlu Havalı Lokma	

C99-E68H2

68 Parça 1/4" + 1/2" 6 Köşe Lokma Takımı



KOD NO	PARÇA SAYISI	FİYAT/TL
C99-E68H2	68	
C02-H	11 PC: 4, 5, 5.5, 6, 7, 8, 9, 10, 11, 12, 13 mm 1/4" 6 Köşe Lokma Anahtar	
C01-12	1/4" Düğmeli Cırcır Kolu	
C01-20	1/4" Lokma Tornavidası (120 mm)	
C01-40	1/4" T Kol (115 mm)	
C01-73	1/4" Uzatma Kolu (100 mm)	
C01-80	1/4" Üniversal Mafsalsal	
F26/BT	C-PLUS Bits Tutucu Tornavida - 1/4" x 100 mm	
BT/8001	1/4" Bits Tutucu Lokma	
CB/610	3 PC: 4, 5.5, 6.5 mm Düz Bits Uç	
CB/250	2 PC: PH1, PH2 Yıldız Bits Uç	
CB/350	2 PC: PZ1, PZ2 Pozitridriv Bits Uç	
CB/800	6 PC: T10, T15, T20, T25, T30, T40 TORX Bits Uç	
CB/1800	4 PC: 3, 4, 5, 6 mm Allen Bits Uç	
C22-H	16 PC: 10, 11, 12, 13, 14, 15, 16, 17, 18, 19, 21, 22, 24, 27, 30, 32 mm 1/2" 6 Köşe Lokma Anahtar	
C21-12	1/2" Düğmeli Cırcır Kolu	
C21-40	1/2" T Kol (250 mm)	
C21-70	2 PC: 125, 250 mm 1/2" Uzatma Kolu	
C21-80	1/2" Üniversal Mafsalsal	
BT/8007	1/2" Bits Tutucu Lokma (5/16" Bitsler için)	
CB/516SL	10 mm 5/16" Düz Bits Uç (Darbeli Kullanım)	
CB/516PH	3 PC: PH2, PH3, PH4 5/16" Yıldız Bits Uç (Darbeli Kullanım)	
CB/516TX	4 PC: T30, T40, T45, T50 5/16" TORX Bits Uç (Darbeli Kullanım)	
CB/516HX	3 PC: 5, 6, 8 mm 5/16" Allen Bits Uç (Darbeli Kullanım)	

C99A-E96BMR

96 Parça 1/4" + 1/2" 12 Köşe (Yıldız) Lokma Takımı - SAE



KOD NO	PARÇA SAYISI	FİYAT/TL
C99A-E96BMR	96	
C02A-B	10 PC: 3/16, 7/32, 1/4, 9/32, 5/16, 11/32, 3/8, 7/16, 1/2, 9/16 inch 1/4" 12 Köşe (Yıldız) Lokma Anahtar - SAE	
C04A-B	10 PC: 3/16, 7/32, 1/4, 9/32, 5/16, 11/32, 3/8, 7/16, 1/2, 9/16 inch 1/4" 12 Köşe (Yıldız) Derin Lokma Anahtar - SAE	
C08S-S	3 PC: 4, 5.5, 6.5 mm 1/4" Düz Uçlu Lokma	
C08S-PH	2 PC: PH1, PH2 1/4" Yıldız Uçlu Lokma	
C08S-PZ	2 PC: PZ1, PZ2 1/4" Pozitridriv Uçlu Lokma	
C08S-T	8 PC: T8, T10, T15, T20, T25, T27, T30, T40 1/4" TORX Uçlu Lokma	
C08AS-H	11 PC: 1/16, 5/64, 3/32, 7/64, 1/8, 9/64, 5/32, 3/16, 7/32, 1/4, 5/16 inch 1/4" Allen Uçlu Lokma - SAE	
C01-T90	1/4" Kapalı Tip Cırcır Kolu (Metal Saplı)	
C01-20	1/4" Lokma Tornavidası (150 mm)	
C01-40	1/4" T Kol (115 mm)	
C01-70	2 PC: 50, 150 mm 1/4" Uzatma Kolu	
C01-75F	1/4" Bükülebilir Uzatma Kolu (150 mm)	
C01-80	1/4" Üniversal Mafsalsal	
C01-92	1/4" Lokma Adaptörü - D:1/4" < E:3/8"	
BT/8001	1/4" Bits Tutucu Lokma	
CB/800T	7 PC: T10, T15, T20, T25, T27, T30, T40 1/4" Delikli TORX Bits Uç	
C22A-B	15 PC: 3/8, 7/16, 1/2, 9/16, 5/8, 11/16, 3/4, 13/16, 7/8, 15/16, 1, 1-1/16, 1-1/8, 1-3/16, 1-1/4 inch 1/2" 12 Köşe (Yıldız) Lokma Anahtar - SAE	
C21-T90	1/2" Kapalı Tip Cırcır Kolu (Metal Saplı)	
C21-40	1/2" T Kol (250 mm)	
C21-70	2 PC: 125, 250 mm 1/2" Uzatma Kolu	
C21-80	1/2" Üniversal Mafsalsal	
C21-91S	1/2" Lokma Adaptörü - D:1/2" > E:3/8"	
C21-92	1/2" Lokma Adaptörü - D:1/2" < E:3/4"	
BT/8007	1/2" Bits Tutucu Lokma (5/16" Bitsler için)	
CB/516SL	10 mm 5/16" Düz Bits Uç (Darbeli Kullanım)	
CB/516PH	3 PC: PH2, PH3, PH4 5/16" Yıldız Bits Uç (Darbeli Kullanım)	
CB/516TX	4 PC: T30, T40, T45, T50 5/16" TORX Bits Uç (Darbeli Kullanım)	
CB/516HX	3 PC: 5, 6, 8 mm 5/16" Allen Bits Uç (Darbeli Kullanım)	





C99-E99H2

99 Parça 1/4" + 1/2" 6 Köşe Lokma Takımı



KOD NO	PARÇA SAYISI	FİYAT/TL
C99-E99H2	99	
C02-H	12 PC: 4, 5, 5.5, 6, 7, 8, 9, 10, 11, 12, 13, 14 mm 1/4" 6 Köşe Lokma Anahtar	
C04-H	11 PC: 4, 5, 5.5, 6, 7, 8, 9, 10, 11, 12, 13 mm 1/4" 6 Köşe Derin Lokma Anahtar	
C08S-S	3 PC: 4, 5, 5.5, 6.5 mm 1/4" Düz Uçlu Lokma	
C08S-PH	2 PC: PH1, PH2 1/4" Yıldız Uçlu Lokma	
C08S-PZ	2 PC: PZ1, PZ2 1/4" Pozitiv Uçlu Lokma	
C08S-T	8 PC: T8, T10, T15, T20, T25, T27, T30, T40 1/4" TORX Uçlu Lokma	
C08S-H	5 PC: 3, 4, 5, 6, 8 mm 1/4" Allen Uçlu Lokma	
C01-12	1/4" Düğmeli Cırcır Kolu	
C01-20	1/4" Lokma Tornavidası (150 mm)	
C01-40	1/4" T Kol (115 mm)	
C01-70	2 PC: 50, 150 mm 1/4" Uzatma Kolu	
C01-75F	1/4" Bükülebilir Uzatma Kolu (150 mm)	
C01-80	1/4" Ünsel Mafsal	
C01-92	1/4" Lokma Adaptörü - D:1/4" < E:3/8"	
BT/8001	1/4" Bits Tutucu Lokma	
CB/800T	7 PC: T10, T15, T20, T25, T27, T30, T40 Delikli TORX Bits Uç	
C22-H	18 PC: 8, 10, 11, 12, 13, 14, 15, 16, 17, 18, 19, 20, 21, 22, 24, 27, 30, 32 mm 1/2" 6 Köşe Lokma Anahtar	
C24-H	3 PC: 13, 17, 19 mm 1/2" 6 Köşe Derin Lokma Anahtar	
C21-12	1/2" Düğmeli Cırcır Kolu	
C21-40	1/2" T Kol (250 mm)	
C21-70	2 PC: 125, 250 mm 1/2" Uzatma Kolu	
C21-80	1/2" Ünsel Mafsal	
C21-91S	1/2" Lokma Adaptörü - D:1/2" > E:3/8"	
C21-92	1/2" Lokma Adaptörü - D:1/2" < E:3/4"	
BT/8007	1/2" Bits Tutucu Lokma (5/16" Bitsler için)	
CB/516SL	10 mm 5/16" Düz Bits Uç (Darbeli Kullanım)	
CB/516PH	3 PC: PH2, PH3, PH4 5/16" Yıldız Bits Uç (Darbeli Kullanım)	
CB/516TX	4 PC: T30, T40, T45, T50 5/16" TORX Bits Uç (Darbeli Kullanım)	
CB/516HX	3 PC: 5, 6, 8 mm 5/16" Allen Bits Uç (Darbeli Kullanım)	

C99-E115H2

115 Parça 1/4" + 3/8" + 1/2" 6 Köşe Lokma Takımı

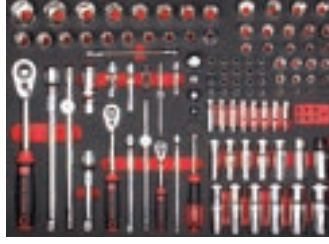

KOD NO	PARÇA SAYISI	FİYAT/TL
C99-E115H2	115	
C02-H	12 PC: 4, 5, 5.5, 6, 7, 8, 9, 10, 11, 12, 13, 14 mm 1/4" 6 Köşe Lokma Anahtar	
C04-H	8 PC: 4, 5, 5.5, 6, 7, 8, 9, 10 mm 1/4" 6 Köşe Derin Lokma Anahtar	
C08S-S	3 PC: 4, 5, 5.5, 6.5 mm 1/4" Düz Uçlu Lokma	
C08S-PH	2 PC: PH1, PH2 1/4" Yıldız Uçlu Lokma	
C08S-PZ	2 PC: PZ1, PZ2 1/4" Pozitiv Uçlu Lokma	
C08S-T	8 PC: T8, T10, T15, T20, T25, T27, T30, T40 1/4" TORX Uçlu Lokma	
C08S-H	5 PC: 3, 4, 5, 6, 8 mm 1/4" Allen Uçlu Lokma	
C01-12	1/4" Düğmeli Cırcır Kolu	
C01-20	1/4" Lokma Tornavidası (150 mm)	
C01-40	1/4" T Kol (115 mm)	
C01-70	2 PC: 50, 150 mm 1/4" Uzatma Kolu	
C01-75F	1/4" Bükülebilir Uzatma Kolu (150 mm)	
C01-80	1/4" Ünsel Mafsal	
C01-92	1/4" Lokma Adaptörü - D:1/4" < E:3/8"	
BT/8001	1/4" Bits Tutucu Lokma	
CB/800T	7 PC: T10, T15, T20, T25, T27, T30, T40 Delikli TORX Bits Uç	
C12-H	14 PC: 8, 9, 10, 11, 12, 13, 14, 15, 16, 17, 18, 19, 21, 22 mm 3/8" 6 Köşe Lokma Anahtar	
C14-H	5 PC: 11, 12, 13, 14, 15 mm 3/8" 6 Köşe Derin Lokma Anahtar	
C11-12	3/8" Düğmeli Cırcır Kolu	
C11-40	3/8" T Kol (200 mm)	
C11-70	2 PC: 75, 150 mm 3/8" Uzatma Kolları	
C11-80	3/8" Ünsel Mafsal	
C11-91	3/8" Lokma Adaptörü - D: 3/8" > E: 1/4"	
C11-92S	3/8" Lokma Adaptörü - D: 3/8" < E: 1/2"	
C22-H	18 PC: 8, 10, 11, 12, 13, 14, 15, 16, 17, 18, 19, 20, 21, 22, 24, 27, 30, 32 mm 1/2" 6 Köşe Lokma Anahtar	
C24-H	6 PC: 16, 17, 18, 19, 22, 24 mm 1/2" 6 Köşe Derin Lokma Anahtar	
C27-R	2 PC: 16, 21 mm 1/2" Buji Lokması (Contalı)	
C21-12	1/2" Düğmeli Cırcır Kolu	
C21-40	1/2" T Kol (250 mm)	
C21-70	2 PC: 125, 250 mm 1/2" Uzatma Kolu	
C21-80	1/2" Ünsel Mafsal	
C21-91S	1/2" Lokma Adaptörü - D:1/2" > E:3/8"	
C21-92	1/2" Lokma Adaptörü - D:1/2" < E:3/4"	

C99-E95H2

95 Parça 1/4" + 1/2" Lokma Takımı



KOD NO	PARÇA SAYISI	FİYAT/TL
C99-E95H2	95	
C02-H	12 PC: 4, 5, 5.5, 6, 7, 8, 9, 10, 11, 12, 13, 14 mm 1/4" 6 Köşe Lokma Anahtar	
C06	5 PC: E4, E5, E6, E7, E8 1/4" Dış TORX Lokma Anahtar	
C08S-S	5.5 mm 1/4" Düz Uçlu Lokma	
C08S-PH	2 PC: PH1, PH2 1/4" Yıldız Uçlu Lokma	
C08S-T	9 PC: T6, T7, T8, T9, T10, T15, T20, T25, T27 1/4" TORX Uçlu Lokma	
C08S-H	4 PC: 3, 4, 5, 6 mm 1/4" Allen Uçlu Lokma	
C01-12	1/4" Düğmeli Cırcır Kolu	
C01-20	1/4" Lokma Tornavidası (150 mm)	
C01-70	3 PC: 50, 100, 150 mm 1/4" Uzatma Kolu	
C01-80	1/4" Ünsel Mafsal	
C01-92	1/4" Lokma Adaptörü - D:1/4" < E:3/8"	
C11-91	3/8" Lokma Adaptörü - D: 3/8" > E: 1/4"	
C11-92S	3/8" Lokma Adaptörü - D: 3/8" < E: 1/2"	
C22-H	17 PC: 10, 11, 12, 13, 14, 15, 16, 17, 18, 19, 20, 21, 22, 24, 27, 30, 32 mm 1/2" 6 Köşe Lokma Anahtar	
C22-B	17 PC: 8, 9, 10, 12, 13, 14, 15, 16, 17, 18, 19, 21, 22, 24, 27, 30, 32 mm 1/2" 12 Köşe (Yıldız) Lokma Anahtar	
C26	6 PC: E10, E12, E14, E16, E18, E20 1/2" Dış TORX Lokma Anahtar	
C64W-H	2 PC: 17, 19 mm 1/2" Havalı Bijon Lokma Anahtar (Plastik Korumalı)	
C21-12	1/2" Düğmeli Cırcır Kolu	
C21-40	1/2" T Kol (250 mm)	
C21-70W	3 PC: 50, 125, 250 mm 1/2" Uzatma Kolu (Bombe Başlı)	
C21-80	1/2" Ünsel Mafsal	
C21-91S	1/2" Lokma Adaptörü - D:1/2" > E:3/8"	
C21-92	1/2" Lokma Adaptörü - D:1/2" < E:3/4"	
C31-91	3/4" Lokma Adaptörü - D:3/4" > E:1/2"	
C62-B	2 PC: 32, 36 mm 1/2" 12 Köşe (Yıldız) Havalı Lokma Anahtar	

1 Takım Arabaları ve Alet Setleri



C99-E114H2

114 Parça 1/4"+3/8"+1/2" Lokma Takımı

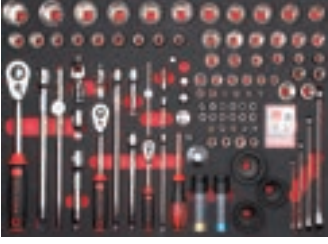

KOD NO	PARÇA SAYISI	FİYAT/TL
C99-E114H2	114	
B17	4 PC: E6xE8, E10xE12, E14xE18, E20xE24 Dış TORX Anahtar	
C02-H	12 PC: 4, 5, 5.5, 6, 7, 8, 9, 10, 11, 12, 13, 14 mm 1/4" 6 Köşe Lokma Anahtar	
C06	5 PC: E4, E5, E6, E7, E8 1/4" Dış TORX Lokma Anahtar	
C08S-S	3 PC: 4.0, 5.5, 6.5 mm 1/4" Düz Uçlu Lokma	
C08S-PH	2 PC: PH1, PH2 1/4" Yıldız Uçlu Lokma	
C08S-PZ	2 PC: PZ1, PZ2 1/4" Pozitiv Uçlu Lokma	
C08S-H	5 PC: 3, 4, 5, 6, 8 mm 1/4" Allen Uçlu Lokma	
C01-12	1/4" Düğmeli Cırcır Kolu	
C01-20	1/4" Lokma Tornavidası (150 mm)	
C01-40	1/4" T Kol (115 mm)	
C01-70	2 PC: 50, 150 mm 1/4" Uzatma Kolu	
C01-80	1/4" Ünsel Mafsal	
C01-92	1/4" Lokma Adaptörü - D:1/4" < E:3/8"	
C12-H	12 PC: 10, 11, 12, 13, 14, 15, 16, 17, 18, 19, 21, 22 mm 3/8" 6 Köşe Lokma Anahtar	
C16	4 PC: E10, E11, E12, E14 3/8" Dış TORX Lokma Anahtar	
C11-12	3/8" Düğmeli Cırcır Kolu	
C11-70	3 PC: 75, 150, 250 mm 3/8" Uzatma Kolu	
C11-80	3/8" Ünsel Mafsal	
C11-91	3/8" Lokma Adaptörü - D: 3/8" > E: 1/4"	
C11-92S	3/8" Lokma Adaptörü - D: 3/8" < E: 1/2"	
C22-B	20 PC: 10, 11, 12, 13, 14, 15, 16, 17, 18, 19, 20, 21, 22, 23, 24, 26, 27, 28, 30, 32 mm 1/2" 12 Köşe (Yıldız) Lokma Anahtar	
C26	4 PC: E16, E18, E20, E24 1/2" Dış TORX Lokma Anahtar	
C64W-H	2 PC: 17, 19 mm 1/2" Havalı Bijon Lokma Anahtar (Plastik Korumalı)	
C21-12	1/2" Düğmeli Cırcır Kolu	
C21-40	1/2" T Kol (250 mm)	
C21-70W	3 PC: 50, 125, 250 mm 1/2" Uzatma Kolu (Bombe Başlı)	
C21-80	1/2" Ünsel Mafsal	
C21-91S	1/2" Lokma Adaptörü - D:1/2" > E:3/8"	
C21-92	1/2" Lokma Adaptörü - D:1/2" < E:3/4"	
C62-B	3 PC: 32, 34, 36 mm 1/2" 12 Köşe (Yıldız) Havalı Lokma Anahtar	
C31-91	3/4" Lokma Adaptörü (D:3/4" > E:1/2)	
CB/800	5 PC: T5, T6, T7, T8, T9 TORX Bits Uç	
CB/800T	7 PC: T10, T15, T20, T25, T27, T30, T40 Delikli TORX Bits Uç	
BT/8001	1/4" Bits Tutucu Lokma	

C99-E77H2

77 Parça 1/4"+1/2" 6 Köşe Lokma ve Lokmalı Bits Seti



KOD NO	PARÇA SAYISI	FİYAT/TL
C99-E77H2	77	
C02-H	12 PC: 4, 5, 5.5, 6, 7, 8, 9, 10, 11, 12, 13, 14 mm 1/4" 6 Köşe Lokma Anahtar	
C04-H	11 PC: 4, 5, 5.5, 6, 7, 8, 9, 10, 11, 12, 13 mm 1/4" 6 Köşe Derin Lokma Anahtar	
C08S-S	3 PC: 4, 5.5, 6.5 mm 1/4" Düz Uçlu Lokma	
C08S-PH	2 PC: PH1, PH2 1/4" Yıldız Uçlu Lokma	
C08S-PZ	2 PC: PZ1, PZ2 1/4" Pozitiv Uçlu Lokma	
C08S-H	5 PC: 3, 4, 5, 6, 8 mm 1/4" Allen Uçlu Lokma	
C01-12	1/4" Düğmeli Cırcır Kolu	
C01-20	1/4" Lokma Tornavidası (150 mm)	
C01-40	1/4" T Kol (115 mm)	
C01-70	2 PC: 50, 150 mm 1/4" Uzatma Kolu	
C01-80	1/4" Ünsel Mafsal	
C01-92	1/4" Lokma Adaptörü - D:1/4" < E:3/8"	
C22-H	17 PC: 10, 11, 12, 13, 14, 15, 16, 17, 18, 19, 20, 21, 22, 24, 27, 30, 32 mm 1/2" 6 Köşe Lokma Anahtar	
C28S-H	8 PC: 5, 6, 7, 8, 10, 12, 14, 17 mm 1/2" Allen Uçlu Lokma	
C64W-H	2 PC: 17, 19 mm 1/2" Havalı Bijon Lokma Anahtar (Plastik Korumalı)	
C21-12	1/2" Düğmeli Cırcır Kolu	
C21-40	1/2" T Kol (250 mm)	
C21-70	2 PC: 125, 250 mm 1/2" Uzatma Kolu	
C21-71W	50 mm 1/2" Uzatma Kolu (Bombe Başlı)	
C21-80	1/2" Ünsel Mafsal	
C21-91S	1/2" Lokma Adaptörü - D:1/2" > E:3/8"	
C21-92	1/2" Lokma Adaptörü - D:1/2" < E:3/4"	

C99-E79H2

79 Parça 3/8" Lokma ve TORX Alet Seti



KOD NO	PARÇA SAYISI	FİYAT/TL
C99-E79H2	79	
B17	4 PC: E6xE8, E10xE12, E14xE18, E20xE24 Dış TORX Anahtar	
B19	10x11 mm Rakor Anahtar	
C06	5 PC: E4, E5, E6, E7, E8 1/4" Dış TORX Lokma Anahtar	
C12-H	15 PC: 7, 8, 9, 10, 11, 12, 13, 14, 15, 16, 17, 18, 19, 21, 22 mm 3/8" 6 Köşe Lokma Anahtar	
C14-H	4 PC: 10, 11, 12, 13 mm 3/8" 6 Köşe Derin Lokma Anahtar	
C12U-B	10 PC: 10, 11, 12, 13, 14, 15, 16, 17, 18, 19 mm 3/8" 12 Köşe (Yıldız) Mafsalı Lokma Anahtar	
C16	4 PC: E10, E11, E12, E14 3/8" Dış TORX Lokma Anahtar	
C18S-H	9 mm 3/8" Allen Uçlu Lokma	
C18S-T	4 PC: T40, T45, T50, T55 3/8" TORX Uçlu Lokma	
C11-12	3/8" Düğmeli Cırcır Kolu	
C11-40	3/8" T Kol (200 mm)	
C11-70	3 PC: 75, 150, 250 mm 3/8" Uzatma Kolu	
C11-80	3/8" Ünsel Mafsal	
C11-91	3/8" Lokma Adaptörü - D: 3/8" > E: 1/4"	
C11-92S	3/8" Lokma Adaptörü - D: 3/8" < E: 1/2"	
C26	4 PC: E16, E18, E20, E24 1/2" Dış TORX Lokma Anahtar	
C28S-T	3 PC: T50, T55, T60 1/2" TORX Uçlu Lokma	
CB/800	4 PC: T6, T7, T8, T9 TORX Bits Uç	
CB/800T	7 PC: T10, T15, T20, T25, T27, T30, T40 Delikli TORX Bits Uç	
BT/8001	1/4" Bits Tutucu Lokma	
CB/3000G	3 PC: (M6, M8, M10) x 30 mm H10 XZN Bits Uçlar (Kısa Tip)	
BT/8005	3/8" Bits Tutucu Lokma (10 mm)	



C99A-E115BMR

115 Parça 1/4" + 3/8" 12 Köşe (Yıldız) Lokma Takımı - SAE



KOD NO	PARÇA SAYISI	FİYAT/TL
C99A-E115BMR	115	
C02A-B	10 PC: 3/16, 7/32, 1/4, 9/32, 5/16, 11/32, 3/8, 7/16, 1/2, 9/16 inch 1/4" 12 Köşe (Yıldız) Lokma Anahtar - SAE	
C02UA-B	9 PC: 7/32, 1/4, 9/32, 5/16, 11/32, 3/8, 7/16, 1/2, 9/16 inch 1/4" 12 Köşe (Yıldız) Mafsallı Lokma Anahtar - SAE	
C04A-B	10 PC: 3/16, 7/32, 1/4, 9/32, 5/16, 11/32, 3/8, 7/16, 1/2, 9/16 inch 1/4" 12 Köşe (Yıldız) Derin Lokma Anahtar - SAE	
C08AS-H	11 PC: 1/16, 5/64, 3/32, 7/64, 1/8, 9/64, 5/32, 3/16, 7/32, 1/4, 5/16 inch 1/4" Allen Uçlu Lokma - SAE	
C01-T90	1/4" Kapalı Tip Cırcır Kolu (Metal Saplı)	
C01-20	1/4" Lokma Tornavidası (150 mm)	
C01-70	2 PC: 50, 150 mm 1/4" Uzatma Kolu	
C01-75F	1/4" Bükülebilir Uzatma Kolu (150 mm)	
C01-80	1/4" Üniversal Mafsallı	
C01-92	1/4" Lokma Adaptörü - D:1/4" < E:3/8"	
C12A-B	13 PC: 1/4, 5/16, 3/8, 7/16, 1/2, 9/16, 5/8, 11/16, 3/4, 13/16, 7/8, 15/16, 1 inch 3/8" 12 Köşe (Yıldız) Lokma Anahtar - SAE	
C14A-B	13 PC: 1/4, 5/16, 3/8, 7/16, 1/2, 9/16, 5/8, 11/16, 3/4, 13/16, 7/8, 15/16, 1 inch 3/8" 12 Köşe (Yıldız) Derin Lokma Anahtar - SAE	
C11-T90	3/8" Kapalı Tip Cırcır Kolu (Metal Saplı)	
C11-36MR	3/8" Mafsallı Kol (Metal Saplı) - 250 mm	
C11-50MR	3/8" Fırdöndü Kol (Metal Avuç Saplı) - 420 mm	
C11-70	3 PC: 75, 150, 250 mm 3/8" Uzatma Kolu	
C11-80	3/8" Üniversal Mafsallı	
C11-91	3/8" Lokma Adaptörü - D: 3/8" > E: 1/4"	
CB/ST31	31 PC: Bits Uç Takımı	
F26/BR2	Bits Cırcır Kolu No.2 - 1/4" x 90 mm	
BT/8001	1/4" Bits Tutucu Lokma	
BT/8003	3/8" Bits Tutucu Lokma	

CF-E108

108 Parça Tornavida ve TORX Alet Seti



KOD NO	PARÇA SAYISI	FİYAT/TL
CF-E108	108	
F10	4 PC: 3.0x75, 4.0x100, 5.5x125, 6.5x150 mm C-PLUS Düz Uçlu Tornavida	
F14	2 PC: PH1x80, PH2x100 mm C-PLUS Yıldız Uçlu Tornavida	
F10/TP	5.5 x 25 mm C-PLUS Topaç Düz Uçlu Tornavida	
F14/TP	PH2 x 25 mm C-PLUS Topaç Yıldız Uçlu Tornavida	
F26/BT	C-PLUS Bits Tutucu Tornavida - 1/4" x 100 mm	
CB/ST31	31 PC: Bits Uç Takımı	
F26/RDS	12-in-1: Cırcırli Topaç Bits Tornavidası	
F26/BR2	Bits Cırcır Kolu No.2 - 1/4" x 90 mm	
6105CP	C-PLUS Kontrol Kalemi (VDE-Küçük)	
G09-11	Oto Elektrik Kontrol Kalemi - 6/24 DC (V)	
F18	7 PC: T10x80, T15x80, T20x100, T25x100, T27x115, T30x115, T40x130 mm C-PLUS TORX Uçlu Tornavida	
LT/900	9 PC: 1.5, 2, 2.5, 3, 4, 5, 6, 8, 10 mm Topbaşı L Allen Anahtar Takımı (Uzun Tip)	
LT/700L	8 PC: T9, T10, T15, T20, T25, T27, T30, T40 TORX L Anahtar Takımı (Uzun Tip)	
C06	6 PC: E4, E5, E6, E7, E8, E10 1/4" Dış TORX Lokma Anahtar	
C26	6 PC: E12, E14, E16, E18, E20, E24 1/2" Dış TORX Lokma Anahtar	
C28S-T	9 PC: (T20, T25, T27, T30, T40, T45, T50, T55, T60) x 55 mm 1/2" TORX Uçlu Lokma - Kısa Tip	
C28S-TL	4 PC: (T30, T40, T45, T50) x 100 mm 1/2" TORX Uçlu Lokma - Uzun Tip	
C28S-XL	4 PC: (M6, M8, M10, M12) x 100 mm 1/2" XZN Uçlu Lokma - Uzun Tip	

EF-E27

27 Parça Alet Seti



KOD NO	PARÇA SAYISI	FİYAT/TL
EF-E27	27	
4100M	4 PC: 3.0x75, 4.0x100, 5.5x125, 6.5x150 mm TOREX Düz Uçlu Tornavida	
4200M	2 PC: PH1x80, PH2x100 mm TOREX Yıldız Uçlu Tornavida	
1300M	5 PC: (6, 7, 8, 10, 13)x125 mm TOREX Lokma Uçlu Tornavida	
LT/9	9 PC: 1.5, 2, 2.5, 3, 4, 5, 6, 8, 10 mm Allen L Anahtar Takımı (Kısa Tip)	
6105CP	C-PLUS Kontrol Kalemi (VDE-Küçük)	
E01-41	180 mm Kombine Pense	
E06-41	160 mm Yan Keski	
E15-41	160 mm Kargaburun	
E30-54	250 mm Papağan Pense (Kutu Mafsallı)	
L01-500	Tesviyeci Çekiçi - 500 gr	
L25-200-2	Düz Keski - 24x 200 mm	

F99-E81

81 Parça Tornavida ve T Saplı Allen Anahtar Seti



KOD NO	PARÇA SAYISI	FİYAT/TL
F99-E81	81	
F10	4 PC: 3.0x75, 4.0x100, 5.5x125, 6.5x150 mm C-PLUS Düz Uçlu Tornavida	
F14	2 PC: PH1x80, PH2x100 mm C-PLUS Yıldız Uçlu Tornavida	
F10/TP	5.5 x 25 mm C-PLUS Topaç Düz Uçlu Tornavida	
F14/TP	PH2 x 25 mm C-PLUS Topaç Yıldız Uçlu Tornavida	
F20	5 PC: (6, 7, 8, 10, 13)x125 mm C-PLUS Lokma Uçlu Tornavida	
K10	6 PC: 2x100, 2.5x100, 3x100, 4x150, 5x150, 6x200 mm T Saplı Allen Anahtar	
LT/900	9 PC: 1.5, 2, 2.5, 3, 4, 5, 6, 8, 10 mm Topbaşı L Allen Anahtar Takımı (Uzun Tip)	
LT/700L	8 PC: T9, T10, T15, T20, T25, T27, T30, T40 TORX L Anahtar Takımı (Uzun Tip)	
F26/BT	C-PLUS Bits Tutucu Tornavida - 1/4" x 100 mm	
CB/ST31	31 PC: Bits Uç Takımı	
F26/RDS	12-in-1: Cırcırli Topaç Bits Tornavidası	
6105CP	C-PLUS Kontrol Kalemi (VDE-Küçük)	

F99A-E80

80 Parça Tornavida ve L/T Anahtar Seti - SAE



KOD NO	PARÇA SAYISI	FİYAT/TL
F99A-E80	80	
F10	4 PC: 3.0x75, 4.0x100, 5.5x125, 6.5x150 mm C-PLUS Düz Uçlu Tornavida	
F14	2 PC: PH1x80, PH2x100 mm C-PLUS Yıldız Uçlu Tornavida	
F10/TP	5.5 x 25 mm C-PLUS Topaç Düz Uçlu Tornavida	
F14/TP	PH2 x 25 mm C-PLUS Topaç Yıldız Uçlu Tornavida	
F20A	3 PC: (1/4, 5/16, 3/8 inch)x125 mm C-PLUS Lokma Uçlu Tornavida - SAE	
K10A	7 PC: 5/64x100, 3/32x100, 1/8x100, 5/32x150, 3/16x150, 1/4x150, 5/16x200 mm T Saplı Allen Anahtar - SAE	
LT/900AF	9 PC: 1/16, 5/64, 3/32, 1/8, 5/32, 3/16, 1/4, 5/16, 3/8 inch Topbaşı L Allen Anahtar Tk. (Uzun Tip) - SAE	
LT/700L	8 PC: T9, T10, T15, T20, T25, T27, T30, T40 TORX L Anahtar Takımı (Uzun Tip)	
F26/BT	C-PLUS Bits Tutucu Tornavida - 1/4" x 100 mm	
CB/ST31	31 PC: Bits Uç Takımı	
F26/RDS	12-in-1: Cırcırli Topaç Bits Tornavidası	
6105CP	C-PLUS Kontrol Kalemi (VDE-Küçük)	

1 Takım Arabaları ve Alet Setleri

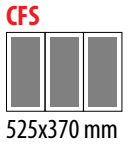

525x370 mm

FLR-E36

36 Parça Alet Seti



KOD NO	PARÇA SAYISI	FİYAT/TL
FLR-E36	36	
F20	4 PC: (7, 8, 10, 13)x125 mm C-PLUS Lokma Uçlu Tornavida	
J45CPM	C-Pro Maket Bıçağı (Metal Gövde) - 18 mm	
J45-R	10 PC: 18 mm Maket Bıçağı Yedeği	
L01-500	Tesviyeci Çekiç - 500 gr	
L12-40	Plastik Kafalı Çekiç - Ø 40 mm	
L12-R40	Yedek Plastik Kafa (L12-40 için) - Tek	
L25-200-2	Düz Keski - 24x200 mm	
L29-4	Nokta Zimba - Ø4 x 120 mm	
L31	4 PC: Ø(3, 4, 5, 6) x 150 mm Düz Pim Zimba	
N21-10	Fren Kaliperi Fırçası - 220 mm	
N31-12	Döşeme Klips Sökme Aleti - 150 mm	
P05-0519	Compact Şerit Metre (5 M x 19 mm)	
P15-030	Paslanmaz Çelik Cetvel- 30 cm	
P54-205	Filler Çakısı (Metrik - 20 Yaprak) (0.05 - 1.0 mm)	
R11-PEN	Kalem Tipi LED Cep Feneri - 100 Lümen	
R15-1000	Mıknatıslı Parça Yakalama (Kap: 1000 gr)- 400 mm	
R36-1	Düz Uçlu Biz	
R36-2	Açılı Uçlu Biz	
R36-3	90° Uçlu Biz	
R36-4	Kanca Uçlu Biz	
R37-25	Conta Kazıma Aleti - 25 x 150 mm	

EF-E34

34 Parça Alet Seti



KOD NO	PARÇA SAYISI	FİYAT/TL
EF-E34	34	
F10	2 PC: 5.5x125, 8.0x150 mm C-PLUS Düz Uçlu Tornavida	
F14	3 PC: PH0x80, PH1x80, PH2x100 mm C-PLUS Yıldız Uçlu Tornavida	
3100/TF2	PH2/6.0 x 175 mm Değişken Uçlu Tornavida	
Z/12	PH1/PH2 x 100 mm Yıldız Uçlu Z Tornavida	
Z/40	4.0/4.0 x 100 mm Düz Uçlu Z Tornavida	
LT/900AF	9 PC: 1/16, 5/64, 3/32, 1/8, 5/32, 3/16, 1/4, 5/16, 3/8 inch Topbaşı L Allen Anahtar Takımı (Uzun Tip)-SAE	
K99-F2M	9 PC: 0.05, 1/16, 5/64, 3/32, 7/64, 1/8, 9/64, 5/32, 3/16 inch Çakı Tipi Allen Anahtar Seti (Metal Kasa) - SAE	
E01-44	180 mm Kombine Pense	
E06-44	160 mm Yan Keski	
E15-44	200 mm Kargaburun	
E16-44	160 mm Eğri Kargaburun	
E30-54	250 mm Papağan Pense (Kutu Mafsal)	
E80-230R	Tel Bükme Pensesi (Çırcırlı) - 230 mm	
E50-2	2 PC: 140, 190 mm Üniversal Ayarlı Pense	

E99-E10

10 Parça Pense Seti



KOD NO	PARÇA SAYISI	FİYAT/TL
E99-E10	10	
E01-41	180 mm Kombine Pense	
E06-41	160 mm Yan Keski	
E15-41	200 mm Kargaburun	
E16-41	200 mm Eğri Kargaburun	
E30-54	250 mm Papağan Pense (Kutu Mafsal)	
E50-2	240 mm Üniversal Ayarlı Pense	
E65-44	180 mm Dış Segman Pensesi (Düz Uçlu-Yaylı)	
E66-44	180 mm Dış Segman Pensesi (Eğri Uçlu-Yaylı)	
E67-44	180 mm İç Segman Pensesi (Düz Uçlu)	
E68-44	180 mm İç Segman Pensesi (Eğri Uçlu)	

F99-E79

79 Parça Tornavida ve L/T Anahtar Seti



KOD NO	PARÇA SAYISI	FİYAT/TL
F99-E79	79	
F10	4 PC: 3.0x75, 4.0x100, 5.5x125, 6.5x150 mm C-PLUS Düz Uçlu Tornavida	
F14	2 PC: PH1x80, PH2x100 mm C-PLUS Yıldız Uçlu Tornavida	
F10/TP	5.5 x 25 mm C-PLUS Topaç Düz Uçlu Tornavida	
F14/TP	PH2 x 25 mm C-PLUS Topaç Yıldız Uçlu Tornavida	
F26/BT	C-PLUS Bits Tutucu Tornavida - 1/4" x 100 mm	
CB/ST31	31 PC: Bits Uç Takımı	
F26/RDS	12-in-1: Çırcırlı Topaç Bits Tornavidası	
F26/BR2	Bits Çırcırlı Kolu No.2 - 1/4" x 90 mm	
6105CP	C-PLUS Kontrol Kalemi (VDE-Küçük)	
G09-11	Oto Elektrik Kontrol Kalemi - 6/24 DC (V)	
F18	7 PC: T10x80, T15x80, T20x100, T25x100, T27x115, T30x115, T40x130 mm C-PLUS TORX Uçlu Tornavida	
LT/900	9 PC: 1.5, 2, 2.5, 3, 4, 5, 6, 8, 10 mm Topbaşı L Allen Anahtar Takımı (Uzun Tip)	
LT/700L	8 PC: T9, T10, T15, T20, T25, T27, T30, T40 TORX L Anahtar Takımı (Uzun Tip)	

EF-E72

72 Parça Alet Seti



KOD NO	PARÇA SAYISI	FİYAT/TL
EF-E72	72	
F10	4 PC: 3.0x75, 4.0x100, 5.5x125, 6.5x150 mm C-PLUS Düz Uçlu Tornavida	
F14	2 PC: PH1x80, PH2x100 mm C-PLUS Yıldız Uçlu Tornavida	
LT/900	9 PC: 1.5, 2, 2.5, 3, 4, 5, 6, 8, 10 mm Topbaşı L Allen Anahtar Takımı (Uzun Tip)	
CB/ST31	31 PC: Bits Uç Takımı	
6105CP	C-PLUS Kontrol Kalemi (VDE-Küçük)	
E01-41	180 mm Kombine Pense	
E06-41	160 mm Yan Keski	
E15-41	200 mm Kargaburun	
E30-54	250 mm Papağan Pense (Kutu Mafsal)	
J45C	Compact Maket Bıçağı - 18 mm	
J45-R	10 PC: 18 mm Maket Bıçağı Yedeği	
L01-500	Tesviyeci Çekiç - 500 gr	
L25-200-2	Düz Keski - 24x200 mm	
L29-4	Nokta Zimba - Ø4 x 120 mm	
L31	4 PC: Ø(3, 4, 5, 6) x 150 mm Düz Pim Zimba	
P05-0519	Compact Şerit Metre (5 M x 19 mm)	
P15-030	Paslanmaz Çelik Cetvel- 30 cm	
P54-205	Filler Çakısı (Metrik - 20 Yaprak) (0.05 - 1.0 mm)	

EL-E28

28 Parça Alet Seti



KOD NO	PARÇA SAYISI	FİYAT/TL
EL-E28	28	
E01-41	180 mm Kombine Pense	
E06-41	160 mm Yan Keski	
E15-41	160 mm Kargaburun	
E30-54	250 mm Papağan Pense (Kutu Mafsal)	
E50-2	240 mm Üniversal Ayarlı Pense	
J45CPM	C-Pro Maket Bıçağı (Metal Gövde) - 18 mm	
J45-R	10 PC: 18 mm Maket Bıçağı Yedeği	
L01-500	Tesviyeci Çekiç - 500 gr	
L12-40	Plastik Kafalı Çekiç - Ø 40 mm	
L12-R40	Yedek Plastik Kafa (L12-40 için) - Tek	
L25-200-2	Düz Keski - 24 x 200 mm	
L29-4	Nokta Zimba - Ø4 x 120 mm	
L31	4 PC: Ø(3, 4, 5, 6) x 150 mm Düz Pim Zimba	
P05-0519	Compact Şerit Metre (5 M x 19 mm)	
P15-030	Paslanmaz Çelik Cetvel- 30 cm	
P54-205	Filler Çakısı (Metrik - 20 Yaprak) (0.05 - 1.0 mm)	



E55-E07

7 Parça Ayarlı Pense Seti



KOD NO	PARÇA SAYISI	FİYAT/TL
E55-E07	7	
E55-2	2 PC: 2x280 mm "C" Tipi Ayarlı Pense	
E55P-2	3 PC: 2x180, 300 mm "C" Tipi Ayarlı Pense (Pabuç Ağız)	
L25-250G-2	Plastik Korumalı Düz Keski - 28x250 mm	
R40-4	Plastik Saplı Tel Fırça (4 Sıra Telli) - 275 mm	

E50-E16

16 Parça Ayarlı Pense Seti

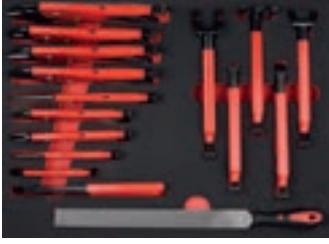

KOD NO	PARÇA SAYISI	FİYAT/TL
E50-E16	16	
E30-54	250 mm Papağan Pense (Kutu Mafsal)	
E50-2	3 PC: 140, 190, 240 mm Üniversal Ayarlı Pense	
E50L-2	2 PC: 170, 230 mm Uzun Burunlu Ayarlı Pense	
E51-2	2 PC: 190, 240 mm Düz Ağızlı Ayarlı Pense	
E52-2	240 mm Özel Ağızlı Ayarlı Pense	
E52S-2	240 mm Özel Ağızlı Ayarlı Pense (Çok Amaçlı Çene)	
E56-J1	210 mm Eksenel Ayarlı Pense - J Tip	
E56-J2	235 mm Eksenel Ayarlı Pense - JJ Tip	
E56-L1	195 mm Eksenel Ayarlı Pense - L Tip	
E56-L2	220 mm Eksenel Ayarlı Pense - LL Tip	
E56-W1	195 mm Eksenel Ayarlı Pense - W Tip	
J55-112H	Standart Eğe (Kalın) - 30 x 300 mm	

GB99-E20

20 Parça 1000V Anahtar Seti

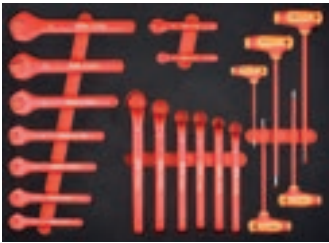

KOD NO	PARÇA SAYISI	FİYAT/TL
GB99-E20	20	
GB09	9 PC: 8, 10, 11, 12, 13, 14, 17, 19, 22 mm 1000V Çatal Ağız Anahtar	
GB14	6 PC: 10, 12, 13, 14, 17, 19 mm 1000V Yıldız Ağız Anahtar	
GK10	5 PC: 3, 4, 5, 6, 8 mm 1000V T-Saplı Allen Anahtar	

GC10-E52H2

52 Parça 3/8" + 1/2" 1000V 6 Köşe Lokma Takımı



KOD NO	PARÇA SAYISI	FİYAT/TL
GC10-E52H2	52	
GC12-H	16 PC: 6, 7, 8, 9, 10, 11, 12, 13, 14, 15, 16, 17, 18, 19, 20, 22 mm 1000V 3/8" 6 Köşe Lokma Anahtar	
GC18S-T	6 PC: (T20, T25, T27, T30, T40, T45)x65 mm 1000V 3/8" TORX Uçlu Lokma	
GC18S-X	2 PC: (M8, M10)x75 mm 3/8" 1000V XZN Uçlu Lokma	
GC18S-H	4 PC: (4, 5, 6, 8)x65 mm 3/8" 1000V Allen Uçlu Lokma	
GC11-12	3/8" 1000V Düğmeli Cırcır Kolu	
GC11-40	3/8" 1000V T-Kol - 210 mm	
GC11-70	2 PC: 93, 170 mm 3/8" 1000V Uzatma Kolu	
GC22-H	16 PC: 10, 11, 12, 13, 14, 15, 16, 17, 18, 19, 20, 22, 24, 27, 30, 32 mm 1/2" 1000V 6 Köşe Lokma Anahtar	
GC21-12	1/2" 1000V Düğmeli Cırcır Kolu	
GC21-40	1/2" 1000V T-Kol - 205 mm	
GC21-70	2 PC: 140, 270 mm 1/2" 1000V Uzatma Kolu	

GF99-E52

52 Parça C-PLUS 1000V Tornavida Takımı

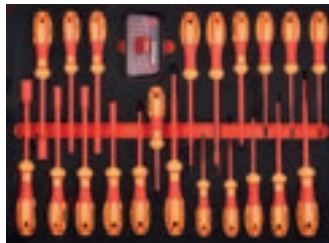

KOD NO	PARÇA SAYISI	FİYAT/TL
GF99-E52	52	
G01	5 PC: 2.5x75, 3.0x100, 4.0x100, 5.5x125, 6.5x150 mm C-PLUS 1000V Düz Uçlu Tornavidalar (VDE)	
G02	3 PC: PH1x80, PH2x100, PH3x150 mm C-PLUS 1000V Yıldız Uçlu Tornavidalar (VDE)	
G04	6 PC: T10x100, T15x100, T20x100, T25x125, T27x150, T30x150 mm C-PLUS 1000V TORX Uçlu Tornavidalar (VDE)	
G07	6 PC: 5.5x125, 6.0x125, 7.0x125, 8.0x125, 10x125, 13x125 mm C-PLUS 1000V Lokma Uçlu Tornavidalar (VDE)	
G26/BT	C-PLUS 1000V Bits Tornavidası (VDE) 1/4" x 100 mm	
CB/ST31	31 PC: Bits Uç Takımı	

GE99-E08

8 Parça 1000V Alet Seti



KOD NO	PARÇA SAYISI	FİYAT/TL
GE99-E08	8	
G10-18	180 mm 1000V Kombine Pense (VDE)	
G12-18	160 mm 1000V Yan Keski (VDE)	
G15-18	200 mm 1000V Kargaburun (VDE)	
G16-18	200 mm 1000V Eğri Kargaburun (VDE)	
G30-58-0170	170 mm 1000V RZR Serisi Kablo Kesici (VDE)	
G25-58-0250	250 mm 1000V Papağan Pense (VDE)	
G40-48-0145	Çok Amaçlı Elektrikli Makası - 145 mm	
G50-P1	1000V Kablo Bıçağı - Düz - 215 mm	

JL-E53

53 Parça Alet Seti



KOD NO	PARÇA SAYISI	FİYAT/TL
JL-E53	53	
J55-108H	Standart Eğe (Kalın) - 20 x 200 mm	
J56-108H	Yarım Yuvarlak Eğe (Kalın) - 20 x 200 mm	
J57-108H	Yuvarlak Eğe (Kalın) - Ø7.5 x 200 mm	
J58-108H	Kare Eğe (Kalın) - 8 x 200 mm	
J59-108H	Üçgen Eğe (Kalın) - 15 x 200 mm	
J75-R06	6 PC: Saatçi Eğe Takımı	
J45CPM	C-Pro Maket Bıçağı (Metal Gövde) - 18 mm	
J45-R	10 PC: 18 mm Maket Bıçağı Yedeği	
L01-500	Tesviyeci Çekiçi - 500 gr	
L12-40	Plastik Kafalı Çekiç - Ø 40 mm	
L12-R40	Yedek Plastik Kafa (L12-40 için) - Tek	
L25-200-2	Düz Keski - 24x 200 mm	
L29-4	Nokta Zimba - Ø4 x 120 mm	
L31	4 PC: Ø(3, 4, 5, 6) x 150 mm Düz Pim Zimba	
P05-0519	Compact Şerit Metre (5 M x 19 mm)	
P15-030	Paslanmaz Çelik Cetvel - 30 cm	
P54-20S	Filler Çakısı (Metrik - 20 Yaprak) (0.05 - 1.0 mm)	
A20S210	19 PC: 1, 1.5, 2, 2.5, 3, 3.5, 4, 4.5, 5, 5.5, 6, 6.5, 7, 7.5, 8, 8.5, 9, 9.5, 10 mm HSS Matkap Ucu Takımı	

1 Takım Arabaları ve Alet Setleri

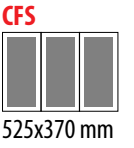

525x370 mm

LPR-E17

17 Parça Alet Seti



KOD NO	PARÇA SAYISI	FİYAT/TL
LPR-E17	17	
L02-16	Bombe Başlı Çekiç - 16 Oz/450 gr	
L12-40	Plastik Kafalı Çekiç - Ø 40 mm	
L12-R40	Yedek Plastik Kafa (L12-40 için) - Tek	
L29	3 PC: Ø3x110, Ø4x120, Ø5x150 mm Nokta Zimba	
L31	2 PC: Ø(2, 5)x150 mm Düz Pim Zimba	
P05A	Compact Şerit Metre (Inch/Metrik) 5M-16 FT x 19 mm	
P15-030	Paslanmaz Çelik Cetvel- 30 cm	
P45A	Mekanik Kumpas - 150 mm	
R.P6	Lumax PRO 2AA El Feneri (Focus)	
R15-0500	Mıknatıslı Parça Yakalama (Spiral Şaftlı) - Kap.:500 gr	
R16-700	Makinist Parmağı (Mıknatıslı) (Kap.: 500 gr)	
R20R	Teleskopik Yuvarlak Ayna- Ø 50 -25/90cm	
R35DE	Çift Uçlu Metal Çizecek -235 mm	
J47SPQ	Katlanır Maket Bıçağı (Trapez Bıçaklı)-19 mm	

ENJ-E21

21 Parça Alet Seti



KOD NO	PARÇA SAYISI	FİYAT/TL
ENJ-E21	21	
K20	6 PC: (6, 7, 8, 10, 11, 13)x125 mm T Saplı Lokma Anahtar	
E36-54	225 mm Betoncu Kerpeteni (PVC Daldırma Sap)	
E50-2	240 mm Üniversal Ayarlı Pense	
L01-300	Tesviyeci Çekiçleri- 300 gr	
L25-250G-2	28x250 mm Plastik Korumalı Düz Keski	
R40-4	275 mm Plastik Saplı Tel Fırça (4 Sıra Telli)	
R35DE	Çift Uçlu Metal Çizecek -235 mm	
N31-1105	5 PC: 5 Parça Döşeme ve Trim Sökme Takımı	
N31-12	150 mm Döşeme Klips Sökme Aleti	
J04-250L	250 mm Mafsallı Sac Makası (Sol Kesim)	
J04-250R	250 mm Mafsallı Sac Makası (Sağ Kesim)	
J81-200	10x200 mm Üç Kenarlı Raspa	

EJ-E07

7 Parça Alet Seti



KOD NO	PARÇA SAYISI	FİYAT/TL
EJ-E07	7	
E01-41	180 mm Kombine Pense	
E30-54	300 mm Papağan Pense (Kutu Mafsallı)	
E36-54	280 mm Betoncu Kerpeteni (PVC Daldırma Sap)	
J04-250L	250 mm Mafsallı Sac Makası (Sol Kesim)	
J04-250R	250 mm Mafsallı Sac Makası (Sağ Kesim)	
N33-04	370 mm Kaportacı Eğe Kolu (Yedekli - 9 TPI Radyal Eğe)	
L20-0401	400 mm Keçe Levyesi	

N30-E12

12 Parça Kaporta Alet Seti



KOD NO	PARÇA SAYISI	FİYAT/TL
N30-E12	12	
N33-04	370 mm Kaportacı Eğe Kolu (Yedekli - 9 TPI Radyal Eğe)	
N33-04R1D	350 mm Kaportacı Eğe Yedeği (Çapraz Kesim) - 9 TPI	
N33-04R1C	350 mm Kaportacı Eğe Yedeği (Radyal Kesim) - 9 TPI	
J55-H	3 PC: 300 mm Standart Eğe - Ergonomik Saplı (Kalın, Orta, İnce)	
N33-02PW	Kama Dayama	
N33-02TO	Tırnak Dayama	
N33-02DE	Topuz Dayam	
N33-02UA	Üniversal Ray Dayama	
N33-02HE	Topuk Dayama	
N33-02PWC	Bombeli Dayama	

N30-E05

5 Parça Kaporta Alet Seti

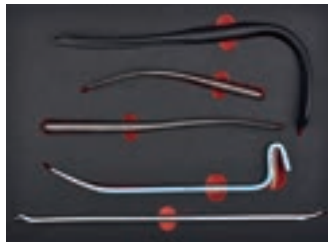

KOD NO	PARÇA SAYISI	FİYAT/TL
N30-E05	5	
N33-03DS	Çift Uçlu Traşca (Açılı ve Düz Uçlar)	
N33-03SL	Uzun Tek Ağızlı Traşca (Düz Ağız)	
N33-03SS	Kısa Tek Ağızlı Traşca (Düz Ağız)	
N33-03BI	Bükme Demiri	
N23-0750	Lastik Levyesi - (500 mm : 20")	

N30-E09

9 Parça Kaporta Alet Seti

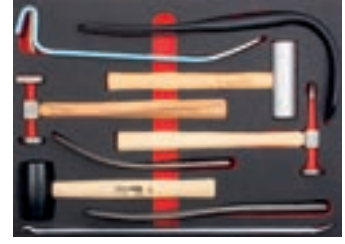

KOD NO	PARÇA SAYISI	FİYAT/TL
N30-E09	9	
N33-03DS	Çift Ağızlı Traşca (Kavisli ve Düz Ağız)	
N33-03SL	Uzun Tek Ağızlı Traşca (Düz Ağız)	
N33-03SS	Kısa Tek Ağızlı Traşca (Düz Ağız)	
N33-03BI	Bükme Demiri	
N33-01BMCZ/MS	Kaportacı Çekici (Düz Yuvarlak ve Tırtıklı Kare Kafa)	
N33-01BPF	Kaportacı Çekici (Düz Yuvarlak ve Sivri Uçlu Bombe Kafa)	
L16-40	Lastik Tokmak- Ø60 mm	
L17-40	Alüminyum Çekiç - Ø 40 mm	
N23-0750	Lastik Levyesi - (500 mm : 20")	

N30-E10

10 Parça Kaporta Alet Seti



KOD NO	PARÇA SAYISI	FİYAT/TL
N30-E10	10	
N33-01BMCZ/MS	Kaportacı Çekici (Düz Yuvarlak ve Tırtıklı Kare Kafa)	
N33-01BPF	Kaportacı Çekici (Düz Yuvarlak ve Sivri Uçlu Bombe Kafa)	
L17-40	Alüminyum Çekiç - Ø 40 mm	
L12-30	Plastik Kafalı Çekiç - Ø 30 mm	
L12-R30	Yedek Kafa (L12-30 için) - Tek	
L12DB-45	Geri Tepmesiz Plastik Çekiç - Ø45 mm	
L01-300	Tesviyeci Çekiçi - 300 gr	
N33-02TO	Tırnak Dayama	
N33-02UA	Üniversal Ray Dayama	
N33-02CW	Virgül Dayama	

B99-E20T

20 Parça Kombine ve Çatal İki Ağız Anahtar Seti

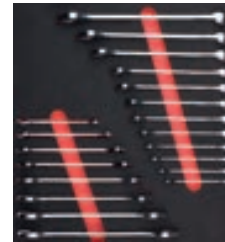

CFS
350x370 mm

KOD NO	PARÇA SAYISI	FİYAT/TL
B99-E20T	20	
B01	12 PC: 6, 7, 8, 9, 10, 11, 12, 13, 14, 17, 19, 22 mm Kombine Anahtar	
B10	8 PC: 6x7, 8x9, 10x11, 12x13, 14x15, 16x17, 18x19, 20x22 mm Çatal İki Ağız Anahtar (Kısa Tip)	

**B01-E12**

12 Parça Kombine Anahtar Takımı

yeni

KOD NO	PARÇA SAYISI	FİYAT/ TL
B01-E12	12	

B01 **12 PC:** 8, 9, 10, 11, 12, 13, 14, 15, 16, 17, 19, 22 mm Kombine Anahtar

B01-E16

16 Parça Kombine Anahtar Takımı



KOD NO	PARÇA SAYISI	FİYAT/ TL
B01-E16	16	

B01 **16 PC:** 6, 7, 8, 9, 10, 11, 12, 13, 14, 15, 16, 17, 18, 19, 22, 24 mm Kombine Anahtar

B01A-E14

14 Parça Kombine Anahtar Takımı - SAE

yeni

KOD NO	PARÇA SAYISI	FİYAT/ TL
B01A-E14	14	

B01A **14 PC:** (1/4, 5/16, 11/32, 3/8, 7/16, 1/2, 9/16, 5/8, 11/16, 3/4, 13/16, 7/8, 15/16, 1 inch) Kombine Anahtar-SAE

B05-E12

12 Parça C-GEAR Cırcırlı Kombine Anahtar Takımı (Düz)



KOD NO	PARÇA SAYISI	FİYAT/ TL
B05-E12	12	

B05 **8 PC:** 8, 10, 11, 12, 13, 14, 17, 19 mm C-GEAR Cırcırlı Kombine Anahtar (Düz)
B05-S **3 PC:** 1/4"- 10 mm, 3/8"- 13 mm, 1/2"- 19 mm C-GEAR Lokma Adaptör
B05-14B 1/4"- 10 mm C-GEAR Bits Adaptörü

B06-E12

12 Parça C-GEAR Cırcırlı Kombine Anahtar Takımı (Mafsallı)



KOD NO	PARÇA SAYISI	FİYAT/ TL
B06-E12	12	

B06 **8 PC:** 8, 10, 11, 12, 13, 14, 17, 19 mm C-GEAR Cırcırlı Kombine Anahtar (Mafsallı)
B05-S **3 PC:** 1/4"- 10 mm, 3/8"- 13 mm, 1/2"- 19 mm C-GEAR Lokma Adaptör
B05-14B 1/4"- 10 mm C-GEAR Bits Adaptörü

B10-E08

8 Parça Çatal İki Ağız Anahtar Takımı (Kısa Tip)

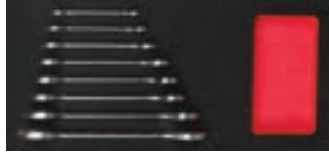

KOD NO	PARÇA SAYISI	FİYAT/ TL
B10-E08	8	

B10 **8 PC:** 6x7, 8x9, 10x11, 12x13, 14x15, 16x17, 18x19, 20x22 mm Çatal İki Ağız Anahtar (Kısa Tip)

B10-E12

12 Parça Çatal İki Ağız Anahtar Takımı (Kısa Tip)

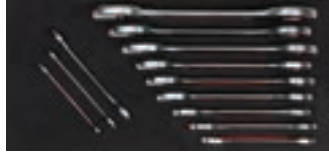

KOD NO	PARÇA SAYISI	FİYAT/ TL
B10-E12	12	

B10 **12 PC:** 6x7, 8x9, 10x11, 12x13, 14x15, 16x17, 18x19, 20x22, 21x23, 24x26, 25x28, 30x32 mm Çatal İki Ağız Anahtar (Kısa Tip)

B09-E08

8 Parça Çatal İki Ağız Anahtar Takımı (Uzun Tip)

yeni

KOD NO	PARÇA SAYISI	FİYAT/ TL
B09-E08	8	

B09 **8 PC:** 6x7, 8x9, 10x11, 12x13, 14x15, 16x17, 18x19, 20x22 mm Çatal İki Ağız Anahtar (Uzun)

B09-E12

12 Parça Çatal İki Ağız Anahtar Takımı (Uzun Tip)

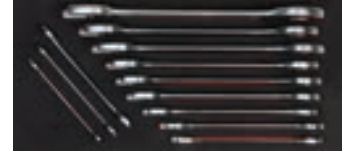
yeni

KOD NO	PARÇA SAYISI	FİYAT/ TL
B09-E12	12	

B09 **12 PC:** 6x7, 8x9, 10x11, 12x13, 14x15, 16x17, 18x19, 20x22, 21x23, 24x26, 25x28, 30x32 mm Çatal İki Ağız Anahtar (Uzun)

B14-E08

8 Parça Yıldız İki Ağız Anahtar Takımı



KOD NO	PARÇA SAYISI	FİYAT/ TL
B14-E08	8	

B14 **8 PC:** 6x7, 8x9, 10x11, 12x13, 14x15, 16x17, 18x19, 20x22 mm Yıldız İki Ağız Anahtar

B17-E18

18 Parça Dış TORX Lokma ve Anahtar Seti

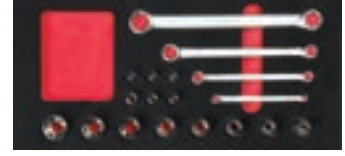

KOD NO	PARÇA SAYISI	FİYAT/ TL
B17-E18	18	

B17 ★ **4 PC:** E06xE08, E10xE12, E14xE18, E20xE24 Dış TORX Anahtar
C06 ★ **6 PC:** E4, E5, E6, E7, E8, E10 1/4" Dış TORX Lokma Anahtar
C26 ★ **8 PC:** E10, E12, E14, E16, E18, E20, E22, E24 1/2" Dış TORX Lokma Anahtar

B28-E08

8 Parça Pipo İki Ağız L Tipi Anahtar Takımı



KOD NO	PARÇA SAYISI	FİYAT/ TL
B28-E08	8	

B28 ○ **8 PC:** 8, 10, 11, 12, 13, 14, 17, 19 mm Pipo İki Ağız L Tipi Anahtar

1 Takım Arabaları ve Alet Setleri

CFS
175x370 mm

K99-10-E06

6 Parça T Saplı Allen Anahtar Takımı



KOD NO	PARÇA SAYISI	FİYAT/TL
K99-10-E06	6	
K10	○ 6 PC: 2, 2.5, 3, 4, 5, 6 mm T-Saplı Allen Anahtar	

K99-10-E15

15 Parça T Saplı ve L Topbaşlı Allen Anahtar Seti



KOD NO	PARÇA SAYISI	FİYAT/TL
K99-10-E15	15	
K10	○ 6 PC: 2, 2.5, 3, 4, 5, 6 mm T Saplı Allen Anahtar	
LT/900	○ 9 PC: 1.5, 2, 2.5, 3, 4, 5, 6, 8, 10 mm Topbaşlı L Allen Anahtar Takımı (Uzun Tip)	

K99-10A-E06

6 Parça T Saplı Allen Anahtar Takımı - SAE



KOD NO	PARÇA SAYISI	FİYAT/TL
K99-10A-E06	6	
K10A	○ 6 PC: 3/32, 1/8, 5/32, 3/16, 7/32, 1/4 inch T-Saplı Allen Anahtar	

K99-10A-E15

15 Parça T Saplı ve L Topbaşlı Allen Anahtar Seti - SAE



KOD NO	PARÇA SAYISI	FİYAT/TL
K99-10A-E15	15	
K10A	○ 6 PC: 3/32, 1/8, 5/32, 3/16, 7/32, 1/4 inch T-Saplı Allen Anahtar	
LT/900AF	○ 9 PC: 1/16, 5/64, 3/32, 1/8, 5/32, 3/16, 1/4, 5/16, 3/8 inch Topbaşlı L Allen Anahtar Takımı (Uzun Tip)	

K99-12-E06

6 Parça T-Saplı TORX Anahtar Seti



KOD NO	PARÇA SAYISI	FİYAT/TL
K99-12-E06	6	
K12	○ 6 PC: T10, T15, T20, T25, T30, T40 T-Saplı TORX Anahtar	

K99-12-E14

14 Parça T Saplı ve L TORX Anahtar Seti



KOD NO	PARÇA SAYISI	FİYAT/TL
K99-12-E14	14	
K12	○ 6 PC: T10, T15, T20, T25, T30, T40 T-Saplı TORX Anahtar	
LT/700L	○ 8 PC: T9, T10, T15, T20, T25, T27, T30, T40 TORX L Anahtar Takımı (Uzun Tip)	

C00-E26H2

26 Parça 1/4" 6 Köşe Lokma ve Allen Anahtar Seti



KOD NO	PARÇA SAYISI	FİYAT/TL
C00-E26H2	26	
C02-H	○ 12 PC: 4, 5, 5.5, 6, 7, 8, 9, 10, 11, 12, 13, 14 mm 1/4" 6 Köşe Lokma Anahtar	
C01-12	1/4" Düğmeli Cırcır Kolu	
C01-40	1/4" T Kol (115 mm)	
C01-70	2 PC: 50, 150 mm 1/4" Uzatma Kolu	
C01-80	1/4" Ünsel Mafsal	
LT/9	○ 9 PC: 1.5, 2, 2.5, 3, 4, 5, 6, 8, 10 mm L Allen Anahtar Takımı (Kısa Tip)	

C00-E52H2

52 Parça 1/4" 6 Köşe Lokma ve Allen Anahtar Seti



KOD NO	PARÇA SAYISI	FİYAT/TL
C00-E52H2	52	
C02-H	○ 12 PC: 4, 5, 5.5, 6, 7, 8, 9, 10, 11, 12, 13, 14 mm 1/4" 6 Köşe Lokma Anahtar	
C04-H	○ 10 PC: 5, 5.5, 6, 7, 8, 9, 10, 11, 12, 13 mm 1/4" 6 Köşe Derin Lokma Anahtar	
C08S-T	○ 7 PC: T10, T15, T20, T25, T27, T30, T40 1/4" TORX Uçlu Lokma	
C08S-H	○ 5 PC: 3, 4, 5, 6, 8 mm 1/4" Allen Uçlu Lokma	
C08S-S	○ 5.5 mm 1/4" Düz Uçlu Lokma	
C08S-PH	○ 2 PC: PH1, PH2 1/4" Yıldız Uçlu Lokma	
C01-12	1/4" Düğmeli Cırcır Kolu	
C01-20	1/4" Lokma Tornavidası (150 mm)	
C01-40	1/4" T Kol (115 mm)	
C01-70	2 PC: 50, 150 mm 1/4" Uzatma Kolu	
C01-80	1/4" Ünsel Mafsal	
LT/9	○ 9 PC: 1.5, 2, 2.5, 3, 4, 5, 6, 8, 10 mm L Allen Anahtar Takımı (Kısa Tip)	

C00A-E15BT

15 Parça 1/4" 12 Köşe (Yıldız) Lokma Anahtar Takımı - SAE



KOD NO	PARÇA SAYISI	FİYAT/TL
C00A-E15BT	15	
C02A-B	○ 10 PC: 3/16, 7/32, 1/4, 9/32, 5/16, 11/32, 3/8, 7/16, 1/2, 9/16 inch 1/4" 12 Köşe (Yıldız) Lokma Anahtar - SAE	
C01-T90	1/4" Kapalı Tip Cırcır Kolu (Metal Saplı)	
C01-20	1/4" Lokma Tornavidası (150 mm)	
C01-70	2 PC: 50, 150 mm 1/4" Uzatma Kolu	
C01-80	1/4" Ünsel Mafsal	

C00A-E25BT

25 Parça 1/4" 12 Köşe (Yıldız) Lokma Anahtar Takımı - SAE



KOD NO	PARÇA SAYISI	FİYAT/TL
C00A-E25BT	25	
C02A-B	○ 10 PC: 3/16, 7/32, 1/4, 9/32, 5/16, 11/32, 3/8, 7/16, 1/2, 9/16 inch 1/4" 12 Köşe (Yıldız) Lokma Anahtar - SAE	
C04A-B	○ 10 PC: 3/16, 7/32, 1/4, 9/32, 5/16, 11/32, 3/8, 7/16, 1/2, 9/16 inch 1/4" 12 Köşe (Yıldız) Derin Lokma Anahtar - SAE	
C01-T90	1/4" Kapalı Tip Cırcır Kolu (Metal Saplı)	
C01-20	1/4" Lokma Tornavidası (150 mm)	
C01-70	2 PC: 50, 150 mm 1/4" Uzatma Kolu	
C01-80	1/4" Ünsel Mafsal	



C00A-E39BT

39 Parça 1/4" 12 Köşe (Yıldız) Lokma Anahtar Takımı - SAE



KOD NO	PARÇA SAYISI	FİYAT/TL
C00A-E39BT	39	
C02A-B	10 PC: 3/16, 7/32, 1/4, 9/32, 5/16, 11/32, 3/8, 7/16, 1/2, 9/16 inch 1/4" 12 Köşe (Yıldız) Lokma Anahtar - SAE	
C04A-B	10 PC: 3/16, 7/32, 1/4, 9/32, 5/16, 11/32, 3/8, 7/16, 1/2, 9/16 inch 1/4" 12 Köşe (Yıldız) Derin Lokma Anahtar - SAE	
C08AS-H	11 PC: 1/16, 5/64, 3/32, 7/64, 1/8, 9/64, 5/32, 3/16, 7/32, 1/4, 5/16 inch 1/4" Allen Uçlu Lokma	
C01-T90	1/4" Kapalı Tip Cırcır Kolu (Metal Saplı)	
C01-20	1/4" Lokma Tornavidası (150 mm)	
C01-70	3 PC: 50, 100, 150 mm 1/4" Uzatma Kolu	
C01-75F	1/4" Bükülebilir Uzatma Kolu (150 mm)	
C01-35MR	1/4" Mafsalı Kol (Metal Sap)	
C01-80	1/4" Üniversal Mafsal	

C00C-E45BHT

45 Parça 1/4" Lokma Anahtar Takımı - Metrik/SAE



KOD NO	PARÇA SAYISI	FİYAT/TL
C00C-E45BHT	45	
C02-H	10 PC: 5,5, 6, 7, 8, 9, 10, 11, 12, 13, 14 mm 1/4" 6 Köşe Lokma Anahtar	
C04-H	10 PC: 5,5, 6, 7, 8, 9, 10, 11, 12, 13, 14 mm 1/4" 6 Köşe Derin Lokma Anahtar	
C02A-B	10 PC: 3/16, 7/32, 1/4, 9/32, 5/16, 11/32, 3/8, 7/16, 1/2, 9/16 inch 1/4" 12 Köşe (Yıldız) Lokma Anahtar - SAE	
C04A-B	10 PC: 3/16, 7/32, 1/4, 9/32, 5/16, 11/32, 3/8, 7/16, 1/2, 9/16 inch 1/4" 12 Köşe (Yıldız) Derin Lokma Anahtar - SAE	
C01-T90	1/4" Kapalı Tip Cırcır Kolu (Metal Saplı)	
C01-20	1/4" Lokma Tornavidası (150 mm)	
C01-70	2 PC: 50, 150 mm 1/4" Uzatma Kolu	
C01-80	1/4" Üniversal Mafsal	

C10-E18H2

18 Parça 3/8" 6 Köşe Lokma Anahtar Takımı



KOD NO	PARÇA SAYISI	FİYAT/TL
C10-E18H2	18	
C12-H	13 PC: 8, 10, 11, 12, 13, 14, 15, 16, 17, 18, 19, 21, 22 mm 3/8" 6 Köşe Lokma Anahtar	
C11-12	3/8" Düğmeli Cırcır Kolu	
C11-40	3/8" T Kol (200 mm)	
C11-70	2 PC: 75, 150 mm 3/8" Uzatma Kolu	
C11-80	3/8" Üniversal Mafsal	

C10A-E17BT

17 Parça 3/8" 12 Köşe (Yıldız) Lokma Anahtar Takımı - SAE



KOD NO	PARÇA SAYISI	FİYAT/TL
C10A-E17BT	17	
C12A-B	13 PC: 1/4, 5/16, 3/8, 7/16, 1/2, 9/16, 5/8, 11/16, 3/4, 13/16, 7/8, 15/16, 1 inch 3/8" 12 Köşe (Yıldız) Lokma Anahtar - SAE	
C11-T90	3/8" Kapalı Tip Cırcır Kolu (Metal Saplı)	
C11-70	2 PC: 75, 150 mm 3/8" Uzatma Kolu	
C11-80	3/8" Üniversal Mafsal	

C10A-E30BT

30 Parça 3/8" 12 Köşe (Yıldız) Lokma Anahtar Takımı - SAE



KOD NO	PARÇA SAYISI	FİYAT/TL
C10A-E30BT	30	
C12A-B	13 PC: 1/4, 5/16, 3/8, 7/16, 1/2, 9/16, 5/8, 11/16, 3/4, 13/16, 7/8, 15/16, 1 inch 3/8" 12 Köşe (Yıldız) Lokma Anahtar - SAE	
C14A-B	13 PC: 1/4, 5/16, 3/8, 7/16, 1/2, 9/16, 5/8, 11/16, 3/4, 13/16, 7/8, 15/16, 1 inch 3/8" 12 Köşe (Yıldız) Derin Lokma Anahtar - SAE	
C11-T90	3/8" Kapalı Tip Cırcır Kolu (Metal Saplı)	
C11-70	2 PC: 75, 150 mm 3/8" Uzatma Kolu	
C11-80	3/8" Üniversal Mafsal	

C24-E13H

13 Parça 1/2" 6 Köşe Derin Lokma Anahtar Takımı



KOD NO	PARÇA SAYISI	FİYAT/TL
C24-E13H	13	
C24-H	13 PC: 10, 11, 12, 13, 14, 15, 16, 17, 18, 19, 21, 22, 24 mm 1/2" 6 Köşe Derin Lokma Anahtar	

C28S-E14H

14 Parça 1/2" Allen Lokmalı Bits Takımı

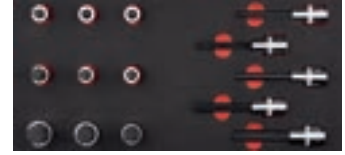

KOD NO	PARÇA SAYISI	FİYAT/TL
C28S-E14H	14	
C28S-H	9 PC: (5, 6, 7, 8, 10, 12, 14, 17, 19) x 55 mm 1/2" Allen Uçlu Lokma - Kısa Tip	
C28S-HL	5 PC: (5, 6, 8, 10, 12) x 100 mm 1/2" Allen Uçlu Lokma - Uzun Tip	

C28S-E29

29 Parça 1/2" TORX-Allen-XZN Lokmalı Bits Takımı

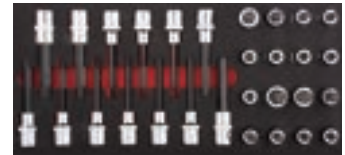

KOD NO	PARÇA SAYISI	FİYAT/TL
C28S-E29	29	
C28S-T	9 PC: (T20, T25, T27, T30, T40, T45, T50, T55, T60) x 55 mm 1/2" TORX Uçlu Lokma - Kısa Tip	
C28S-TL	4 PC: (T30, T40, T45, T50) x 100 mm 1/2" TORX Uçlu Lokma - Uzun Tip	
C28S-H	7 PC: (5, 6, 7, 8, 10, 12, 14) x 55 mm 1/2" Allen Uçlu Lokma - Kısa Tip	
C28S-HL	4 PC: (6, 8, 10, 12 mm) x 100 mm 1/2" Allen Uçlu Lokma - Uzun Tip	
C28S-XL	5 PC: (M6, M8, M10, M12, M14) x 100 mm 1/2" XZN Uçlu Lokma - Uzun Tip	

C20-E23H2

23 Parça 1/2" 6 Köşe Lokma Anahtar Takımı



KOD NO	PARÇA SAYISI	FİYAT/TL
C20-E23H2	23	
C22-H	18 PC: 8, 10, 11, 12, 13, 14, 15, 16, 17, 18, 19, 20, 21, 22, 24, 27, 30, 32 mm 1/2" 6 Köşe Lokma Anahtar	
C21-12	1/2" Düğmeli Cırcır Kolu	
C21-40	1/2" T Kol (250 mm)	
C21-70	2 PC: 125, 250 mm 1/2" Uzatma Kolu	
C21-80	1/2" Üniversal Mafsal	

1 Takım Arabaları ve Alet Setleri

CFS
175x370 mm

C20A-E20BT

20 Parça 1/2" 12 Köşe (Yıldız) Lokma Anahtar Takımı - SAE



KOD NO	PARÇA SAYISI	FİYAT/ TL
C20A-E20BT	20	

- C22A-B ○ 15 PC: 3/8, 7/16, 1/2, 9/16, 5/8, 11/16, 3/4, 13/16, 7/8, 15/16, 1, 1-1/16, 1-1/8, 1-3/16, 1-1/4 inch
1/2" 12 Köşe (Yıldız) Lokma Anahtar - SAE
- C21-T90 1/2" Kapalı Tip Cırcır Kolu (Metal Saplı)
- C21-40 1/2" T Kol (250 mm)
- C21-70 2 PC: 125, 250 mm 1/2" Uzatma Kolu
- C21-80 1/2" Ünsel Mafsal

C28-SSE40

40 Parça H10 TORX-Allen-XZN Lokmalı Bits Uç Tk.

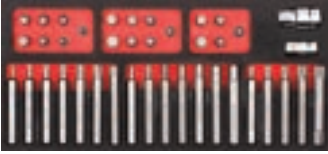

KOD NO	PARÇA SAYISI	FİYAT/ TL
C28-SSE40	40	

- BT/8005 ○ 3/8" Bits Tutucu Lokma (10 mm)
- BT/8008 ○ 1/2" Bits Tutucu Lokma (10 mm)
- CB/1000 7 PC: (T20, T25, T30, T40, T45, T50, T55) x 30 mm
H10 TORX Bits Uç - Kısa Tip
- CB/1100G 7 PC: (T20, T25, T30, T40, T45, T50, T55) x 75 mm
H10 TORX Bits Uç - Uzun Tip
- CB/2000G ○ 7 PC: (4, 5, 6, 7, 8, 10, 12) x 30 mm
H10 Allen Bits Uç - Kısa Tip
- CB/2100G ○ 7 PC: (4, 5, 6, 7, 8, 10, 12) x 75 mm
H10 Allen Bits Uç - Uzun Tip
- CB/3000G ○ 5 PC: (M5, M6, M8, M10, M12) x 30 mm
H10 XZN Bits Uç - Kısa Tip
- CB/3100G ○ 5 PC: (M5, M6, M8, M10, M12) x 75 mm
H10 XZN Bits Uç - Uzun Tip

C62-E10

10 Parça 1/2" 6 Köşe Havalı Lokma Anahtar Takımı



KOD NO	PARÇA SAYISI	FİYAT/ TL
C62-E10	10	

- C62-H ○ 9 PC: 13, 15, 16, 17, 18, 19, 21, 22, 24 mm
1/2" 6 Köşe Havalı Lokma Anahtar
- C61-80 ○ 1/2" Havalı Ünsel Mafsal

C64-E10/2

10 Parça 1/2" 6 Köşe Havalı Derin Lokma Anahtar Tk.



KOD NO	PARÇA SAYISI	FİYAT/ TL
C64-E10/2	10	

- C64-H ○ 9 PC: 13, 15, 16, 17, 18, 19, 21, 22, 24 mm
1/2" 6 Köşe Havalı Derin Lokma Anahtar
- C61-80 ○ 1/2" Havalı Ünsel Mafsal

F99-E701

7 Parça C-PLUS Düz-PH Tornavida Takımı

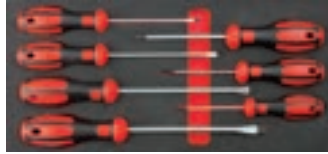

KOD NO	PARÇA SAYISI	FİYAT/ TL
F99-E701	7	

- F10 5 PC: 3x75, 4x100, 5.5x125, 6.5x150, 8x150 mm
C-PLUS Düz Uçlu Tornavida
- F14 2 PC: PH1x80, PH2x100 mm
C-PLUS Yıldız Uçlu Tornavida

4000M-E701

7 Parça TOREX Düz-PH Tornavida Takımı



KOD NO	PARÇA SAYISI	FİYAT/ TL
4000M-E701	7	

- 4100M 5 PC: 3x75, 4x100, 5.5x125, 6.5x150, 8x150 mm
TOREX Düz Uçlu Tornavida
- 4200M 2 PC: PH1x80, PH2x100 mm
TOREX Yıldız Uçlu Tornavida

F99-E3901

39 Parça C-PLUS Düz-PH Tornavida ve Bits Seti



KOD NO	PARÇA SAYISI	FİYAT/ TL
F99-E3901	39	

- F10 4 PC: 3x75, 4x100, 5.5x125, 6.5x150 mm
C-PLUS Düz Uçlu Tornavida
- F14 2 PC: PH1x80, PH2x100 mm
C-PLUS Yıldız Uçlu Tornavida
- F26/BT C-PLUS Bits Tutucu Tornavida - 1/4"x100 mm
- CB/ST31 31 PC: Bits Uç Takımı
- 6105CP C-PLUS Kontrol Kalem (VDE-Küçük)

F99-E3902

39 Parça C-PLUS Düz-PZ Tornavida ve Bits Seti



KOD NO	PARÇA SAYISI	FİYAT/ TL
F99-E3902	39	

- F10 4 PC: 3x75, 4x100, 5.5x125, 6.5x150 mm
C-PLUS Düz Uçlu Tornavida
- F17 2 PC: PZ1x80, PZ2x100 mm
C-PLUS Pozitif Uçlu Tornavida
- F26/BT C-PLUS Bits Tutucu Tornavida - 1/4"x100 mm
- CB/ST31 31 PC: Bits Uç Takımı
- 6105CP C-PLUS Kontrol Kalem (VDE-Küçük)

F99-E0705

7 Parça C-PLUS TORX Tornavida Takımı



KOD NO	PARÇA SAYISI	FİYAT/ TL
F99-E0705	7	

- F18 7 PC: T10x80, T15x80, T20x100, T25x100, T27x115, T30x115, T40x130 mm
C-PLUS TORX Uçlu Tornavida

F99-E0706

7 Parça C-PLUS Delikli TORX Tornavida Takımı



KOD NO	PARÇA SAYISI	FİYAT/ TL
F99-E0706	7	

- F19 7 PC: T10x80, T15x80, T20x100, T25x100, T27x115, T30x115, T40x130 mm
C-PLUS Delikli TORX Uçlu Tornavida

4400M-E701

7 Parça TOREX TORX Tornavida Takımı

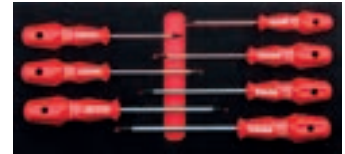

KOD NO	PARÇA SAYISI	FİYAT/ TL
4400M-E701	7	

- 4400M 7 PC: T10x80, T15x80, T20x100, T25x100, T27x115, T30x115, T40x130 mm
TOREX TORX Uçlu Tornavida



F99-E0507

5 Parça C-PLUS Lokma Tornavida Takımı

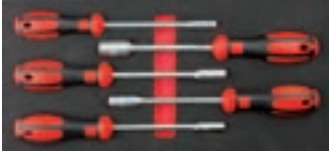

KOD NO	PARÇA SAYISI	FİYAT/ TL
F99-E0507	5	

F20 ○ 5 PC: (6, 7, 8, 10, 13)x125 mm C-PLUS Lokma Uçlu Tornavida

1300M-E501

5 Parça TOREX Lokma Tornavida Takımı

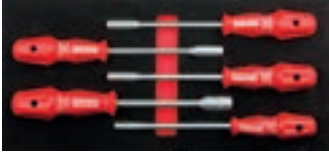

KOD NO	PARÇA SAYISI	FİYAT/ TL
1300M-E501	5	

1300M ○ 5 PC: (6, 7, 8, 10, 13)x125 mm TOREX Lokma Uçlu Tornavida

E99-41-E0103

3 Parça DuoTech Pense Takımı (Polisajlı)



KOD NO	PARÇA SAYISI	FİYAT/ TL
E99-41-E0103	3	

E01-41 180 mm Kombine Pense
E06-41 160 mm Yan Keski
E15-41 160 mm Kargaburun

E99-E0502

2 Parça Pense Seti



KOD NO	PARÇA SAYISI	FİYAT/ TL
E99-E0502	2	

E30-54 250 mm Papağan Pense (Kutu Mafsal)
E50-2 240 mm Üniversal Ayarlı Pense

E99-44-E0404

4 Parça Segman Pensesi Takımı



KOD NO	PARÇA SAYISI	FİYAT/ TL
E99-44-E0404	4	

E65-44 180 mm Dış Segman Pensesi (Düz Uçlu-Yaylı)
E66-44 180 mm Dış Segman Pensesi (Eğri Uçlu-Yaylı)
E67-44 180 mm İç Segman Pensesi (Düz Uçlu)
E68-44 180 mm İç Segman Penseleri (Eğri Uçlu)

G99-E701

7 Parça C-PLUS VDE 1000V Düz-PH Tornavida Takımı



KOD NO	PARÇA SAYISI	FİYAT/ TL
G99-E701	7	

G01 ● 4 PC: 3x100, 4x100, 5.5x125, 6.5x150 mm C-PLUS 1000V Düz Uçlu Tornavida (VDE Onaylı)
G02 ⊕ 2 PC: PH1x80, PH2x100 mm C-PLUS 1000V Yıldız Uçlu Tornavida (VDE Onaylı)
G105CP ● C-PLUS Kontrol Kalem (VDE-Küçük)

G99-18-E0103

3 Parça DuoTech VDE 1000 V Pense Takımı



KOD NO	PARÇA SAYISI	FİYAT/ TL
G99-18-E0103	3	

G10-18 180 mm 1000V Kombine Pense (VDE Onaylı)
G12-18 160 mm 1000V Yan Keski (VDE Onaylı)
G15-18 160 mm 1000V Kargaburun (VDE Onaylı)

H99-E06

6 Parça C-TRONIC Mikro Pense ve Cımbız Seti



KOD NO	PARÇA SAYISI	FİYAT/ TL
H99-E06	6	

H305-1105B Elektronikçi Yan Keski (Açılı Kesim) -110 mm
H315-1205B Elektronikçi Tepe Keski-120 mm
H335-120 Elektronikçi Kargaburun (Dişli Tutma Yüzeği)- 120 mm
H37-120 Elektronikçi Yassı Kargaburun- 120 mm
H43-120-SA Küt Uçlu Cımbız (Düz)- 120 mm
H43-125B-SA Küt Uçlu Cımbız (Eğri)- 125 mm

H99-31-E0310

10 Parça C-TRONIC Mikro Pense ve Tornavida Seti



KOD NO	PARÇA SAYISI	FİYAT/ TL
H99-31-E0310	10	

H305-1105B Elektronikçi Yan Keski (Açılı Kesim) -110 mm
H335-120 Elektronikçi Kargaburun (Dişli Tutma Yüzeği)- 120 mm
H355-140 Elektronikçi İğne Kargaburun- 140 mm
H01 4 PC: 1.5x40, 2.0x60, 2.5x80, 3.0x80 mm Düz Uçlu Elektronikçi Tornavida
H02 2 PC: PH00x60, PH0x60 mm Yıldız Uçlu Elektronikçi Tornavida
H43-120-SA Küt Uçlu Cımbız (Düz)- 120 mm

J72-E0811

11 Parça Tesviyeci ve Saatçi Eğe Takımı



KOD NO	PARÇA SAYISI	FİYAT/ TL
J72-E0811	11	

J55-108H Standart Eğe (Kalın) - 20 x 200 mm
J56-108H Yarım Yuvarlak Eğe (Kalın) - 20 x 200 mm
J57-108H Yuvarlak Eğe (Kalın) - 07.5 x 200 mm
J58-108H Kare Eğe (Kalın) - 8 x 200 mm
J59-108H Üçgen Eğe (Kalın) - 15 x 200 mm
J75-R06 6 PC: Saatçi Eğe Takımı

JP99-E06

6 Parça Ölçüm ve Kesim Alet Seti



KOD NO	PARÇA SAYISI	FİYAT/ TL
JP99-E06	6	

J04-250S 250 mm Mafsalı Sac Makası (Düz Kesim)
R35CT Karbür Uçlu Metal Çizecek- 145 mm
J45C Compact Maket Bıçağı - 18 mm
P05-0519 Compact Şerit Metre (5 M x 19 mm)
P15-030 Paslanmaz Çelik Cetvel- 30 cm
P54-20S Filler Çakısı (Metrik - 20 Yaprak) (0.05 - 1.0 mm)

1 Takım Arabaları ve Alet Setleri

CFS
175x370 mm

L99-E02 2 Parça Çekiç Seti



KOD NO	PARÇA SAYISI	FİYAT/TL
L99-E02	2	
L01-500	Tesviyeci Çekiçi - 500 gr	
L12-40	Plastik Kafalı Çekiç - Ø 40 mm	

L99-E08 8 Parça Çekiç ve Keski Seti



KOD NO	PARÇA SAYISI	FİYAT/TL
L99-E08	8	
L01-500	Tesviyeci Çekiçi - 500 gr	
L12-40	Plastik Kafalı Çekiç - Ø 40 mm	
L25-200-2	Düz Keski - 24 x 200 mm	
L29-4	Nokta Zimba - Ø4 x 120 mm	
L31	4 PC: Ø(3, 4, 5, 6) x 150 mm Düz Pim Zimba	

R01-E05 5 Parça Perçin Tabancası Seti



KOD NO	PARÇA SAYISI	FİYAT/TL
R01-E05	5	
R01-STD	Perçin Tabancası (Yeni Jenerasyon)	
BR	4x20 PC: 2.4x6, 3.2x8, 4x12, 4.8x20 mm Perçin	

yeni
içerik

R99-E24 24 Parça Genel Bakım Seti



KOD NO	PARÇA SAYISI	FİYAT/TL
R99-E24	24	
A205210	19 PC: 1, 1.5, 2, 2.5, 3, 3.5, 4, 4.5, 5, 5.5, 6, 6.5, 7, 7.5, 8, 8.5, 9, 9.5, 10 mm HSS Matkap Ucu Takımı	
R11-MINI	LED Cep Feneri (Kompakt) - 70 Lümen	
J45C	Compact Maket Bıçağı - 18 mm	
P05-0519	Compact Şerit Metre (5 M x 19 mm)	
P15-030	Paslanmaz Çelik Cetvel- 30 cm	
P54-205	Filler Çakısı (Metrik - 20 Yaprak) (0.05 - 1.0 mm)	

yeni
içerik

R99-E32 32 Parça Matkap Ucu ve Darbeli Tornavida Seti



KOD NO	PARÇA SAYISI	FİYAT/TL
R99-E32	32	
A205210	19 PC: 1, 1.5, 2, 2.5, 3, 3.5, 4, 4.5, 5, 5.5, 6, 6.5, 7, 7.5, 8, 8.5, 9, 9.5, 10 mm HSS Matkap Ucu Takımı	
R15-1000	Mıknatıslı Parça Yakalama (Kap: 1000 gr)- 400 mm	
F28/BT	5/16" Darbeli Bits Tornavidası	
CB/516SL	10 mm 5/16" Düz Bits Uç (Darbeli Kullanım)	
CB/516PH	3 PC: PH2, PH3, PH4	
CB/516TX	5/16" Yıldız Bits Uç (Darbeli Kullanım)	
CB/516TX	4 PC: T30, T40, T45, T50	
CB/516TX	5/16" TORX Bits Uç (Darbeli Kullanım)	
CB/516HX	3 PC: 5, 6, 8 mm	
CB/516HX	5/16" Allen Bits Uç (Darbeli Kullanım)	

N14-E11 11 Parça Karter Tapa ve Yağ Filtre Sökme Seti



KOD NO	PARÇA SAYISI	FİYAT/TL
N14-E11	11	
N14-0615	Metal Bantlı Yağ Filtre Anahtar (65-100 mm)	
N14-10	Karter Tapa Anahtar- 285 mm (8 x 10 mm)	
N14-12S	3 PC: 8, 10, 12 mm	
N14-12H	3/8" Kare Uçlu Karter Tapa Lokması	
N14-12H	5 PC: 8, 10, 12, 14, 17 mm	
N14-12H	3/8" Altı Köşe Uçlu Karter Tapa Lokması	
C11-40	3/8" T Kol- 200 mm	

N23-E05 5 Parça Lastik Bakım Seti



KOD NO	PARÇA SAYISI	FİYAT/TL
N23-E05	5	
C64W-H	3 PC: 17, 19, 21 mm	
N23-08TD	1/2" Havalı Bijon Lokma Anahtar (Plastik Korumalı)	
N23-08TD	Dijital Lastik Diş Derinlik Kumpası - (0-25 mm)	
N23-0831	Lastik Hava Basınç Ölçer (Otomobiller için) 10 - 120 psi	

N43-E09 9 Parça Oto Elektrik Seti



KOD NO	PARÇA SAYISI	FİYAT/TL
N43-E09	9	
G09-11	Oto Elektrik Kontrol Kalem- 6/24 DC (V)	
G09-16	Profesyonel Oto Elektrik Kontrol Kalem- 3/48 DC (V)	
E69-YT1	İzoleli Kablo Pabucu Sıkma Pensesi (0.5 - 6.0 mm ²)	
KYK	6 SET: Kablo Pabucu	

N17-E09 9 Parça Özel Oto Lokma Takımı



KOD NO	PARÇA SAYISI	FİYAT/TL
N17-E09	9	
N17-05	3 PC: 22x78, 22x110, 27x78 mm	
N17-05	1/2" Dizel Enjektör Lokması	
N18-1522S	3/8" Oksijen (Lambda) Sensör Lokması- 22x90 mm	
N18-1522SL	1/2" Açılı Oksijen (Lambda) Sensör Lokması- 22 mm	
C17-R14C	3/8" 12 Köşe Buji Lokması (İnce Cidarlı)	
C27-R	2 PC: 16, 21 mm 1/2" Buji Lokması (Contalı)	
C21-915	1/2" Lokma Adaptörü - D:1/2" E:3/8"	

yeni

N36-E04 4 Parça Cam Sökme Kiti



KOD NO	PARÇA SAYISI	FİYAT/TL
N36-E04	4	
N36-WRT	Cam Sökme Aparatı	
N36-WH2	Cam Ayırma Telleri için Tutucu Sap (Çift)	
N36-CS0722	Cam Macunu Kesme Teli (0.7 mm Kare) - 22 metre	

yeni

AE00 5 Bölmeli Boş Eva Modülü



KOD NO	PARÇA SAYISI	FİYAT/TL
AE00	-	

Bu modül özellikle 2 modüllü çekmeceleri 3 modüle tamamlamaya yarar ve vida, somun, pul gibi parçaların depolanması için kullanılır.

JUNIOR Genel Maksatlı Alet Seti

121 Parça

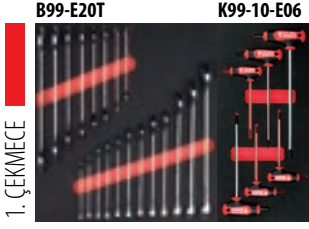

121 Parça JUNIOR Alet Seti

Sadece İçerik



121 Parça JUNIOR Alet Setleri (Takım Arabalı)

(A50TK-121T+A01-06)

(A50TK-121T+A02-06)



GT Plus
6 ÇEKMECE



GT
6 ÇEKMECE

KOD NO **A50TK-121T**

A50TK-121A01T

A50TK-121A02T

FİYAT / TL

JUNIOR Genel Maksatlı Alet Seti

123 Parça

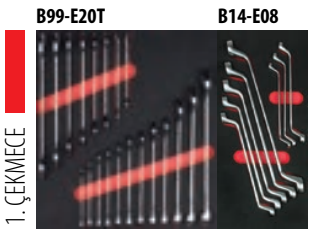

123 Parça JUNIOR Alet Seti

Sadece İçerik

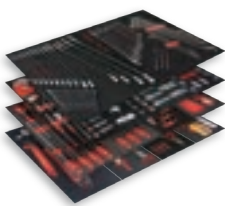

123 Parça JUNIOR Alet Setleri (Takım Arabalı)

(A50TK-123T+A01-06)

(A50TK-123T+A02-06)



GT Plus
6 ÇEKMECE



GT
6 ÇEKMECE

KOD NO **A50TK-123T**

A50TK-123A01T

A50TK-123A02T

FİYAT / TL

1 Takım Arabaları ve Alet Setleri

JUNIOR Genel Maksatlı Alet Seti

164 Parça



164 Parça JUNIOR Genel Maksatlı Alet Seti

164 Parça JUNIOR Genel Maksatlı Alet Setleri (Takım Arabalı)

Sadece İçerik



(A50TK-164+A01-06)

(A50TK-164+A02-06)



GT PLUS
6 ÇEKMECE



GT
6 ÇEKMECE

KOD NO A50TK-164T

A50TK-164A01T

A50TK-164A02T

FİYAT / TL

MIDI-1 Genel Maksatlı Alet Seti

232 Parça



232 Parça MIDI-1 Genel Maksatlı Alet Seti

232 Parça MIDI-1 Genel Maksatlı Alet Setleri (Takım Arabalı)

Sadece İçerik



(A50TK-232/1T+A01M-06)

(A50TK-232/1T+A01-06)

(A50TK-232/1T+A02-06)



GT MAX
6 ÇEKMECE



GT PLUS
6 ÇEKMECE



GT
6 ÇEKMECE

KOD NO A50TK-232/1T

A50TK-232/1A01MT

A50TK-232/1A01T

A50TK-232/1A02T

FİYAT / TL

MIDI-2 Genel Maksatlı Alet Seti

232 Parça

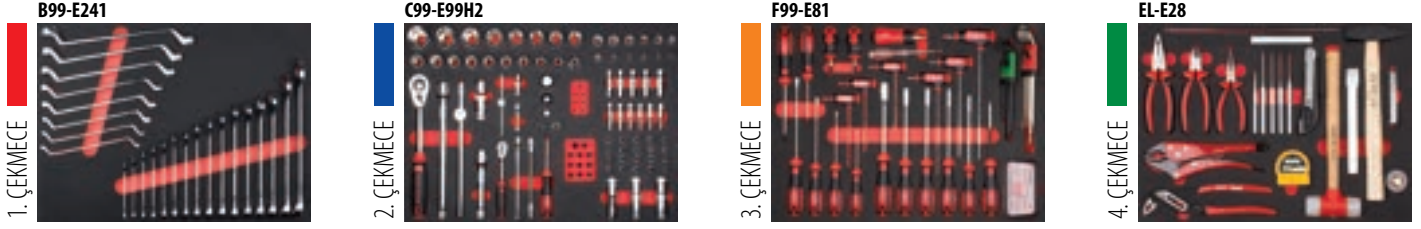

232 Parça MIDI-2 Genel Maksatlı Alet Seti

Sadece İçerik



232 Parça MIDI-2 Genel Maksatlı Alet Setleri (Takım Arabalı)

(A50TK-232/2+A01M-06)

(A50TK-232/2+A01-06)

(A50TK-232/2+A02-06)



GT
MAX
6 ÇEKMECE



GT
PLUS
6 ÇEKMECE



GT
6 ÇEKMECE

KOD NO	A50TK-232/2	A50TK-232/2A01M	A50TK-232/2A01	A50TK-232/2A02
FİYAT / TL				

MIDI-SAE Genel Maksatlı Alet Seti

230 Parça



230 Parça MIDI-SAE Genel Maksatlı Alet Seti

Sadece İçerik



230 Parça MIDI-SAE Genel Maksatlı Alet Setleri (Takım Arabalı)

(A50TK-230+A01M-06)

(A50TK-230+A01-06)

(A50TK-230+A02-06)



GT
MAX
6 ÇEKMECE



GT
PLUS
6 ÇEKMECE



GT
6 ÇEKMECE

KOD NO	A50TK-230	A50TK-230A01M	A50TK-230A01	A50TK-230A02
FİYAT / TL				

1 Takım Arabaları ve Alet Setleri

MAXI Genel Maksatlı Alet Seti

275 Parça

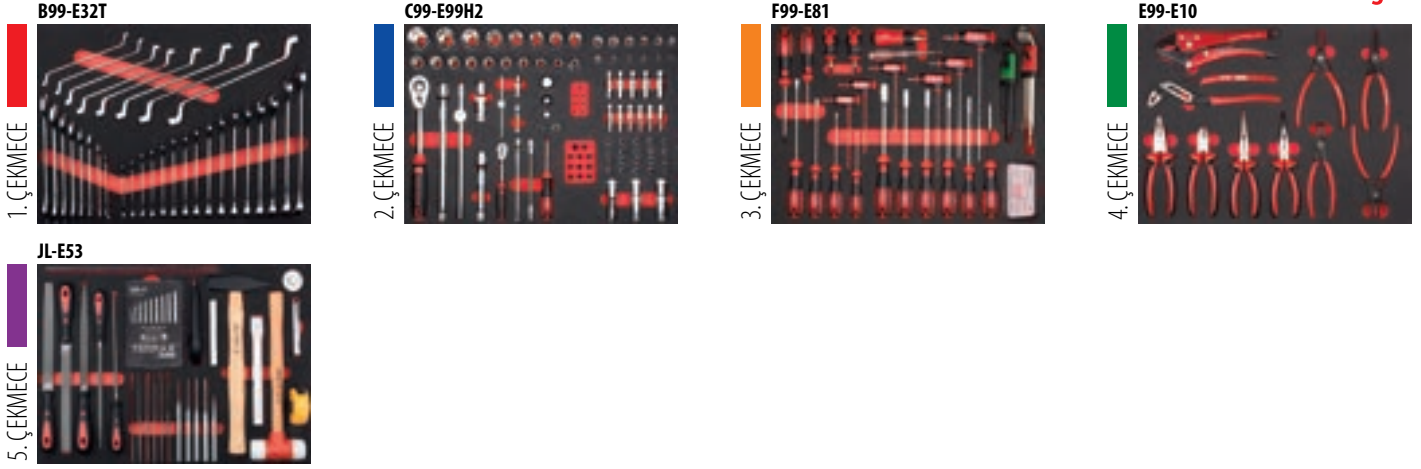

275 Parça MAXI Genel Maksatlı Alet Seti

Sadece İçerik



KOD NO	A50TK-275T
FİYAT / TL	

275 Parça MAXI Genel Maksatlı Alet Setleri (Takım Arabalı)

(A50TK-275T+A01M-07)



A50TK-275A01MT

(A50TK-275T+A01-07)



A50TK-275A01T

SUPER MAXI Genel Maksatlı Alet Seti

343 Parça

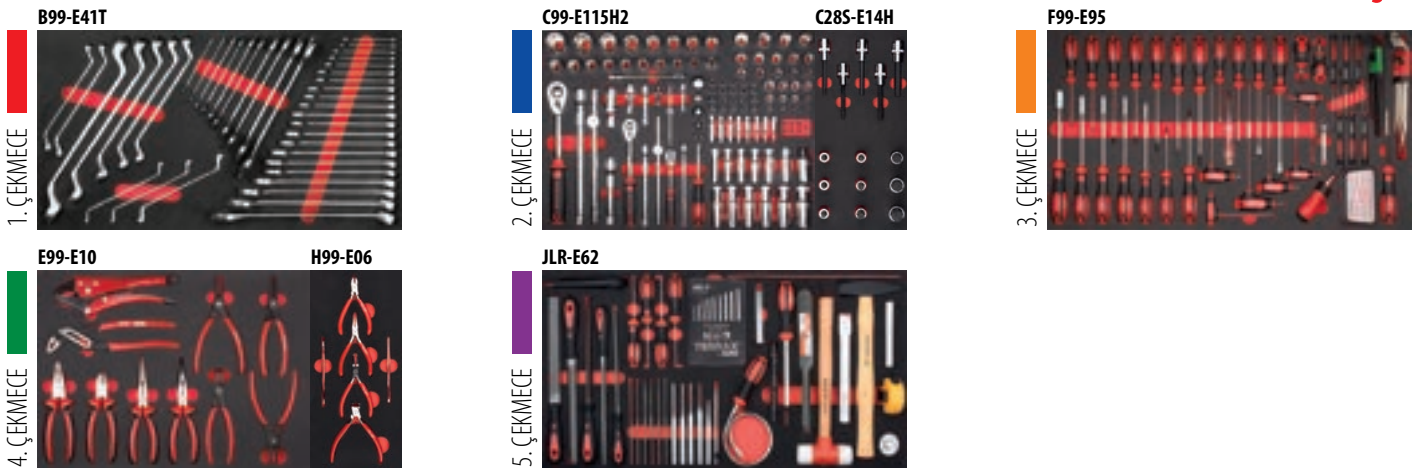

343 Parça SUPER MAXI Genel Maksatlı Alet Seti

Sadece İçerik

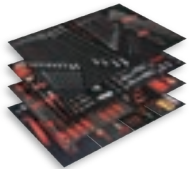

KOD NO	A50TK-343T
FİYAT / TL	

343 Parça SUPER MAXI Genel Maksatlı Alet Setleri (Takım Arabalı)

(A50TK-343T+A01M-07J)



A50TK-343A01MT

(A50TK-343T+A01-07J)



A50TK-343A01T

AERO MIDI Havacılık Alet Seti

197 Parça

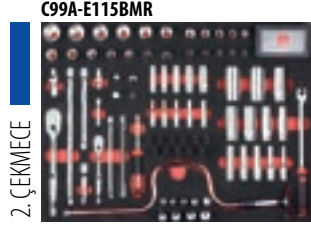

197 Parça AERO MIDI Havacılık Alet Seti

Sadece İçerik



KOD NO **A50AS-197**
FİYAT / TL

197 Parça AERO MIDI Havacılık Alet Setleri (Takım Arabalı)

(A50AS-197+A01M-06)



A50AS-197A01M

(A50AS-197+A01-06)



A50AS-197A01

AUTO MAXI Otomotiv Alet Seti

293 Parça

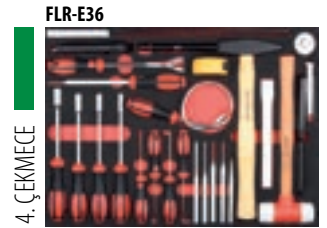
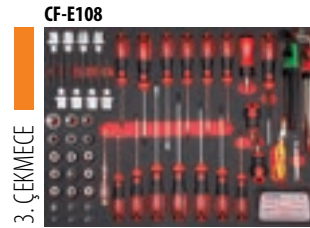

293 Parça AUTO MAXI Otomotiv Alet Seti

Sadece İçerik



KOD NO **A50CR-293**
FİYAT / TL

293 Parça AUTO MAXI Otomotiv Alet Setleri (Takım Arabalı)

(A50CR-293+A01M-07)



A50CR-293A01M

(A50CR-293+A01-07)



A50CR-293A01

1 Takım Arabaları ve Alet Setleri

AUTO SUPER MAXI Otomotiv Alet Seti

350 Parça

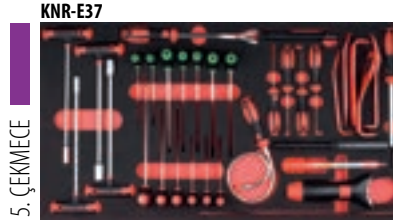
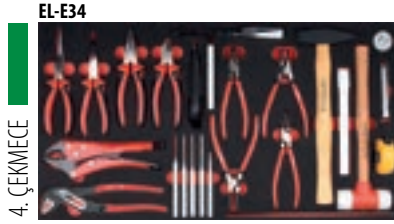
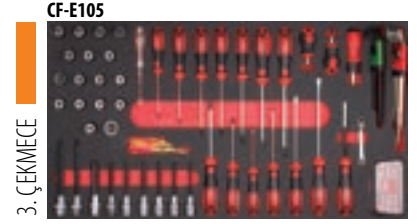
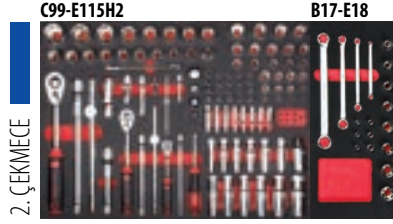
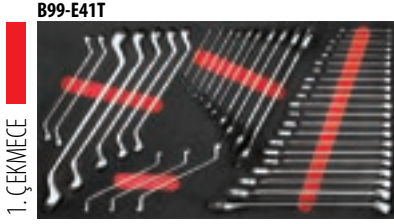

350 Parça AUTO SUPER MAXI Otomotiv Alet Seti

Sadece İçerik



350 Parça AUTO SUPER MAXI Otomotiv Alet Setleri (Takım Arabalı)

(A50CR-350T+A01M-07J)

(A50CR-350T+A01-07J)



KOD NO A50CR-350T
FİYAT / TL

A50CR-350A01MT

A50CR-350A01T

VW Mekanik Otomotiv Alet Seti

292 Parça

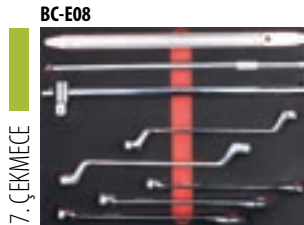

292 Parça VW Mekanik Otomotiv Alet Seti

Sadece İçerik



292 Parça VW Mekanik Otomotiv Alet Setleri (Takım Arabalı)

(A50VW-292+A01M-08)

(A50VW-292+A01-08)



KOD NO A50VW-292
FİYAT / TL

A50VW-292A01M

A50VW-292A01

MERCEDES BENZ Mekanik Otomotiv Alet Seti

319 Parça

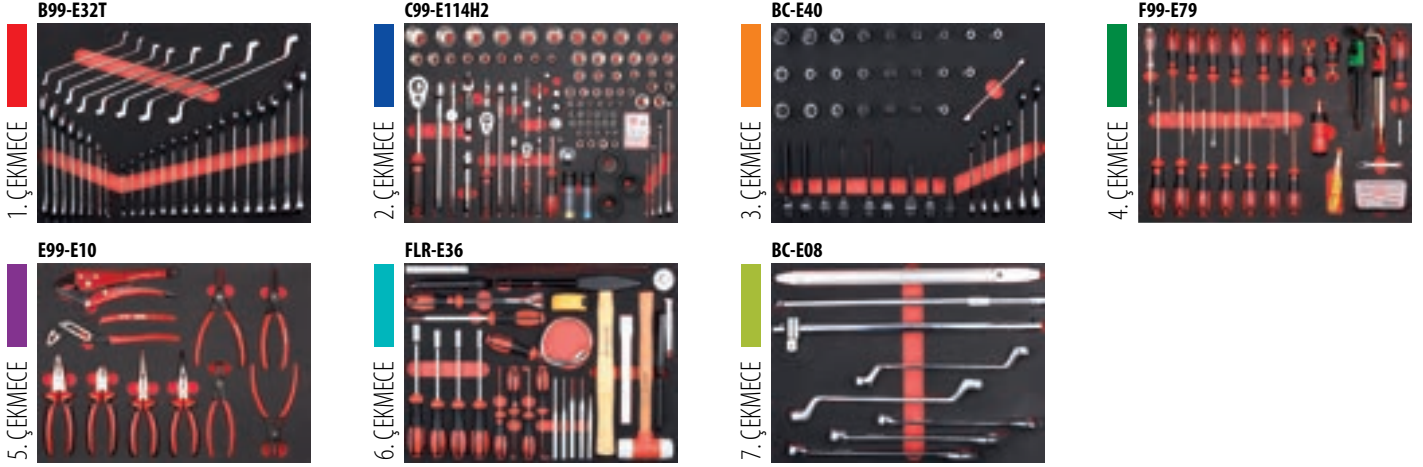

319 Parça MB Mekanik Otomotiv Alet Seti

Sadece İçerik



319 Parça MB Mekanik Otomotiv Alet Setleri (Takım Arabalı)

(A50MB-319T+A01M-08)

(A50MB-319T+A01-08)



KOD NO **A50MB-319T**
FİYAT / TL

A50MB-319A01MT

A50MB-319A01T

BMW Mekanik Otomotiv Alet Seti

321 Parça

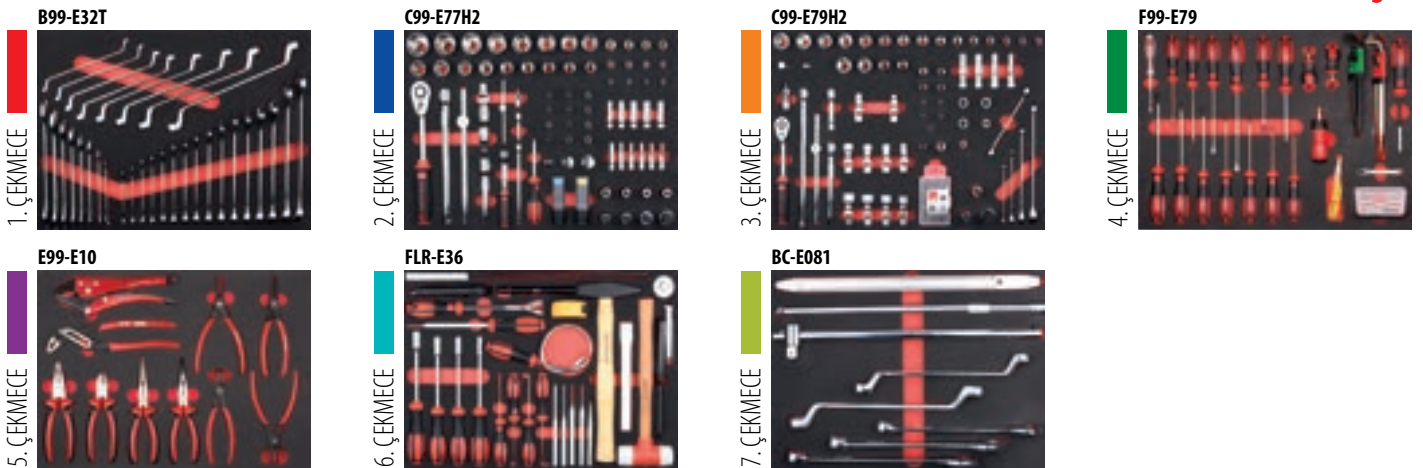

321 Parça BMW Mekanik Otomotiv Alet Seti

Sadece İçerik

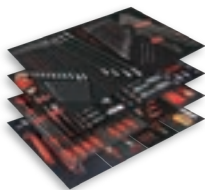

321 Parça BMW Mekanik Otomotiv Alet Setleri (Takım Arabalı)

(A50BMW-321T+A01M-08)

(A50BMW-321T+A01-08)



KOD NO **A50BMW-321T**
FİYAT / TL

A50BMW-321A01MT

A50BMW-321A01T

1 Takım Arabaları ve Alet Setleri

ELEKTRİKLİ / HİBRİT Otomotiv Alet Seti

yeni

132 Parça

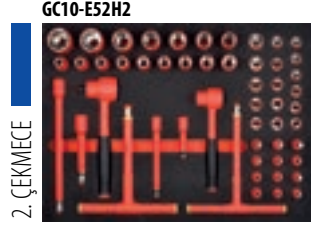

132 Parça Elektrikli/Hibrit Otomotiv Alet Seti

Sadece İçerik



132 Parça Elektrikli/Hibrit Otomotiv Alet Setleri (Takım Arabalı)

(A50EV-132+A01M-06EV)

(A50EV-132+A01-06EV)



KOD NO **A50EV-132**
FİYAT / TL

A50EV-132A01M

A50EV-132A01

ALÜMİNYUM KAPORTA Otomotiv Alet Seti

84 Parça

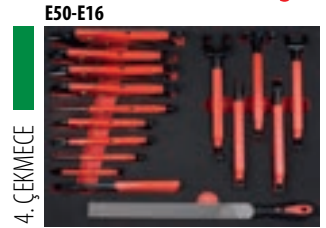
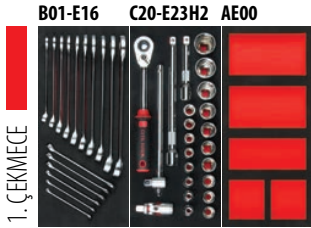

84 Parça ALÜMİNYUM KAPORTA Otomotiv Alet Seti

Sadece İçerik



84 Parça ALÜMİNYUM KAPORTA Otomotiv Alet Setleri (Takım Arabalı)

(A50BR-84+A01M-08)

(A50BR-84+A01-08)



KOD NO **A50BR-84**
FİYAT / TL

A50BR-84A01M

A50BR-84A01

KAPORTA Otomotiv Alet Seti

153 Parça

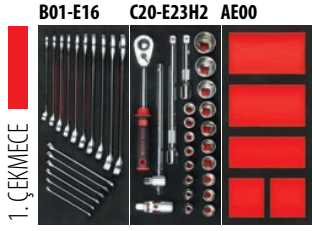

153 Parça KAPORTA Otomotiv Alet Seti

Sadece İçerik



153 Parça KAPORTA Otomotiv Alet Setleri (Takım Arabalı)

(A50BR-153+A01M-07)

(A50BR-153+A01-07)



KOD NO	A50BR-153
FİYAT / TL	

A50BR-153A01M

A50BR-153A01

2 Anahtarlar ve Allenler

36 | 48



B01 Serisi Kombine Anahtarlar

yeni
tasarım



KOD NO	mm	mm		FİYAT/TL
B01-05/2	5.5	100	12	
B01-06	6	100	12	
B01-07	7	110	12	
B01-08	8	120	12	
B01-09	9	130	12	
B01-10	10	140	12	
B01-11	11	150	12	
B01-12	12	160	12	
B01-13	13	170	12	
B01-14	14	180	12	
B01-15	15	190	12	
B01-16	16	200	12	
B01-17	17	210	12	
B01-18	18	220	12	
B01-19	19	230	12	
B01-20	20	240	12	
B01-21	21	250	12	
B01-22	22	260	12	
B01-23	23	270	6	
B01-24	24	280	6	
B01-25	25	290	6	
B01-26	26	300	6	
B01-27	27	310	6	
B01-28	28	320	6	
B01-30	30	330	6	
B01-32	32	360	6	
B01-34	34	385	6	
B01-36	36	400	3	
B01-38	38	400	3	
B01-41	41	440	3	
B01-46	46	490	1	
B01-50	50	530	1	



Teşhir kartlı sipariş için = Ürün Kodu + X
32 mm den büyük ölçülerde sunulmaz



Kart Bedeli
6

B01-R Serisi Kombine Anahtar Takımları (Bez Çantalı)



KOD NO		FİYAT/TL
B01-R12	1	
12 PC: 8, 9, 10, 11, 12, 13, 14, 15, 16, 17, 19, 22 mm		
B01-R13	1	
13 PC: 8, 9, 10, 11, 12, 13, 14, 15, 16, 17, 19, 21, 24 mm		
B01-R21	1	
21 PC: 6, 7, 8, 9, 10, 11, 12, 13, 14, 15, 16, 17, 18, 19, 20, 21, 22, 24, 27, 30, 32 mm		

B01-B Serisi Kombine Anahtar Takımları (Karton Kutulu)



KOD NO		FİYAT/TL
B01-B08	1	
8 PC: 8, 10, 11, 12, 13, 14, 17, 19 mm		
B01-B12	1	
12 PC: 8, 9, 10, 11, 12, 13, 14, 15, 16, 17, 19, 22 mm		
B01-B12/2	1	
12 PC: 6, 7, 8, 9, 10, 11, 12, 13, 14, 17, 19, 22 mm		
B01-B17	1	
17 PC: 6, 7, 8, 9, 10, 11, 12, 13, 14, 15, 16, 17, 18, 19, 20, 21, 22 mm		
B01-B21	1	
21 PC: 6, 7, 8, 9, 10, 11, 12, 13, 14, 15, 16, 17, 18, 19, 20, 21, 22, 24, 27, 30, 32 mm		
B01-B25	1	
25 PC: 6, 7, 8, 9, 10, 11, 12, 13, 14, 15, 16, 17, 18, 19, 20, 21, 22, 23, 24, 25, 26, 27, 28, 30, 32 mm		

B01-P12 12 Parça Kombine Anahtar Takımı (Plastik Klipsli)

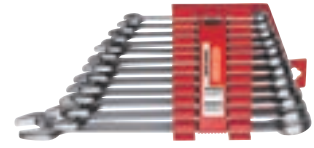

KOD NO		FİYAT/TL
B01-P12	1	
12 PC: 8, 9, 10, 11, 12, 13, 14, 15, 16, 17, 19, 22 mm		

B01AS Serisi Kombine Anahtarlar (Kısa Tip) - SAE



KOD NO	mm	mm		FİYAT/TL
B01AS-00108	1/8	77	6	
B01AS-00532	5/32	77	6	
B01AS-00316	3/16	82	6	
B01AS-00732	7/32	82	6	
B01AS-00732B*	7/32	82	6	

* Kapalı ağız kısmı 12 köşe (yıldız)

B01A Serisi

Kombine Anahtarlar - SAE

yeni
tasarım

KOD NO	mm	mm	mm	FİYAT/TL
B01A-00104	1/4	100	6	
B01A-00932	9/32	110	6	
B01A-00516	5/16	120	6	
B01A-01132	11/32	130	6	
B01A-00308	3/8	140	6	
B01A-00716	7/16	150	6	
B01A-00102	1/2	170	6	
B01A-00916	9/16	180	6	
B01A-00508	5/8	200	6	
B01A-01116	11/16	210	6	
B01A-00304	3/4	230	6	
B01A-01316	13/16	250	6	
B01A-00708	7/8	260	6	
B01A-01516	15/16	280	6	
B01A-10000	1	290	6	
B01A-10116	1 - 1/16	310	6	
B01A-10108	1 - 1/8	320	6	
B01A-10316	1 - 3/16	330	6	
B01A-10104	1 - 1/4	360	6	
B01A-10308	1 - 3/8	385	6	
B01A-10102	1 - 1/2	400	6	

Teşhir kartlı sipariş için = Ürün Kodu + X
1-1/4 inch den büyük ölçülerde sunulmaz

Kart Bedeli 6

B05 Serisi

C-GEAR Cırcırlı Kombine Anahtarlar (Düz)



KOD NO	mm	mm	mm	FİYAT/TL
B05-08	8	136	6	
B05-09	9	143	6	
B05-10	10	160	6	
B05-11	11	168	6	
B05-12	12	174	6	
B05-13	13	180	6	
B05-14	14	193	6	
B05-15	15	200	6	
B05-16	16	216	6	
B05-17	17	233	6	
B05-18	18	239	6	
B05-19	19	250	6	
B05-21	21	285	6	
B05-22	22	285	6	
B05-24	24	325	6	
B05-27	27	354	3	
B05-30	30	425	3	
B05-32	32	425	3	
B05-36	36	482	2	

Teşhir kartlı sipariş için = Ürün Kodu + X
24 mm den büyük ölçülerde sunulmaz

Kart Bedeli 6

B05-R Serisi

C-GEAR Cırcırlı Kombine Anahtar Takımları (Düz)



KOD NO	FİYAT/TL
B05-R05	1
5 PC: 8, 10, 13, 17, 19 mm	
B05-R12	1
12 PC: 8, 9, 10, 11, 12, 13, 14, 15, 16, 17, 18, 19 mm	

B01A-R Serisi

Kombine Anahtar Takımları (Bez Çantalı) - SAE



KOD NO	FİYAT/TL
B01A-R09	1
9 PC: 1/4, 5/16, 3/8, 7/16, 1/2, 9/16, 5/8, 11/16, 3/4 inch	
B01A-R14	1
14 PC: 1/4, 5/16, 11/32, 3/8, 7/16, 1/2, 9/16, 5/8, 11/16, 3/4, 13/16, 7/8, 15/16, 1 inch	
B01A-R16	1
16 PC: 1/4, 5/16, 3/8, 7/16, 1/2, 9/16, 5/8, 11/16, 3/4, 13/16, 7/8, 15/16, 1, 1-1/16, 1-1/8, 1-1/4 inch	

B05-P12

12 Parça C-GEAR Cırcırlı Kombine Anahtar Takımı (Düz)



KOD NO	FİYAT/TL
B05-P12	1
8, 10, 11, 12, 13, 14, 17, 19 mm	
B05-14B 1/4"-10 mm	
B05-14S 3/8"-13 mm	
B05-12S 1/2"-19 mm	

B05R Serisi

C-GEAR Cırcırlı Kombine Anahtarlar (Özel Ağızlı)



KOD NO	mm	mm	mm	FİYAT/TL
B05R-09	9	160	6	
B05R-11	11	165	6	
B05R-12	12	175	6	
B05R-14	14	190	6	
B05R-15	15	200	6	
B05R-16	16	205	6	
B05R-18	18	235	6	

B07-B01

4'lü Cırcırlı Kombine Anahtar



KOD NO	mm	mm	mm	FİYAT/TL
B07-B01	10x13 - 19x17	200	6	

B06 Serisi

C-GEAR Cırcırlı Kombine Anahtarlar (Mafsallı)



KOD NO	mm	mm	mm	FİYAT/TL
B06-08	8	135	6	
B06-09	9	160	6	
B06-10	10	160	6	
B06-11	11	175	6	
B06-12	12	175	6	
B06-13	13	185	6	
B06-14	14	195	6	
B06-15	15	215	6	
B06-16	16	215	6	
B06-17	17	230	6	
B06-18	18	250	6	
B06-19	19	250	6	

Teşhir kartlı sipariş için = Ürün Kodu + X

Kart Bedeli 6

B06-R Serisi

C-GEAR Cırcırlı Kombine Anahtar Takımları (Mafsallı)



KOD NO	FİYAT/TL
B06-R05	1
5 PC: 8, 10, 13, 17, 19 mm	
B06-R12	1
12 PC: 8, 9, 10, 11, 12, 13, 14, 15, 16, 17, 18, 19 mm	

2 Anahtarlar ve Allenler

B05-S Serisi

C-GEAR Lokma Adaptörleri



KOD NO	"	mm	mm	FİYAT/TL
B05-14S	1/4	10	12	
B05-38S	3/8	13	6	
B05-12S	1/2	19	6	

B05-14B

C-GEAR Bits Adaptörü



KOD NO	"	mm	FİYAT/TL
B05-14B	1/4	10	6

B05-S04

4 Parça C-GEAR Adaptör Takımı



KOD NO	FİYAT/TL
B05-S04	10

4 PC: B05-14S, B05-38S, B05-12S, B05-14B

B05AR Serisi

C-GEAR Cırcırlı Kombine Anahtarlar (Mandallı) - SAE



KOD NO	"	mm	FİYAT/TL
B05AR-0732	7/32	124	6
B05AR-0104	1/4	124	6
B05AR-0932	9/32	124	6
B05AR-0516	5/16	136	6
B05AR-1132	11/32	142	6
B05AR-0308	3/8	160	6
B05AR-0716	7/16	168	6
B05AR-0102	1/2	180	6
B05AR-0916	9/16	190	6
B05AR-0508	5/8	215	6
B05AR-1116	11/16	230	6
B05AR-0304	3/4	248	6

B07A Serisi

Cırcırlı Yıldız Anahtarlar (Düz) - SAE



KOD NO	"	mm	FİYAT/TL
B07A-0102	1/4x5/16	116	6
B07A-0203	5/16x11/32	136	6
B07A-0304	3/8x7/16	144	6
B07A-0506	1/2x9/16	177	6

B07A-B04

4 Parça Cırcırlı Yıldız Anahtar Takımı (Düz) - SAE



KOD NO	FİYAT/TL
B07A-B04	1

4 PC: 1/4x5/16, 5/16x11/32, 3/8x7/16, 1/2x9/16 inch

B07A0 Serisi

Cırcırlı Yıldız Anahtarlar (Eğik) - SAE



KOD NO	"	mm	FİYAT/TL
B07A0-0102	1/4 x 5/16	112	6
B07A0-0203	5/16 x 11/32	130	6
B07A0-0304	3/8 x 7/16	138	6
B07A0-0506	1/2 x 9/16	172	6

B07A0-B04

4 Parça Cırcırlı Yıldız Anahtar Takımı (Eğik) - SAE



KOD NO	FİYAT/TL
B07A0-B04	1

4 PC: 1/4x5/16, 5/16x11/32, 3/8x7/16, 1/2x9/16 inch

B10 Serisi

Çatal İki Ağz Anahtarlar (Kısa Tip)



KOD NO	mm	mm	FİYAT/TL
B10-0607	6x 7	97	12
B10-0809	8x 9	108	12
B10-1011	10x11	120	12
B10-1013	10x13	120	12
B10-1213	12x13	133	12
B10-1415	14x15	147	12
B10-1317	13x17	162	12
B10-1617	16x17	162	12
B10-1719	17x19	178	12
B10-1819	18x19	178	12
B10-1922	19x22	195	12
B10-2022	20x22	195	12
B10-2123	21x23	213	6
B10-2224	22x24	213	6
B10-2426	24x26	232	6
B10-2427	24x27	232	6
B10-2528	25x28	250	6
B10-2732	27x32	260	6
B10-3032	30x32	260	6

Teşhir kartlı sipariş için = Ürün Kodu + X 6 Kart Bedeli

B10-R Serisi

Çatal İki Ağz Anahtar Takımları (Kısa Tip-Bez Çantalı)



KOD NO	FİYAT/TL
B10-R08	1

8 PC: 6x7, 8x9, 10x11, 12x13, 14x15, 16x17, 18x19, 20x22 mm

KOD NO	FİYAT/TL
B10-R12	1

12 PC: 6x7, 8x9, 10x11, 12x13, 14x15, 16x17, 18x19, 20x22, 21x23, 24x26, 25x28, 30x32 mm

B10-B Serisi

Çatal İki Ağz Anahtar Takımları (Kısa Tip)- Karton Kutulu



KOD NO	FİYAT/TL
B10-B06	1

6 PC: 6x7, 8x9, 10x11, 12x13, 14x15, 16x17 mm

KOD NO	FİYAT/TL
B10-B08	1

8 PC: 6x7, 8x9, 10x11, 12x13, 14x15, 16x17, 18x19, 20x22 mm

KOD NO	FİYAT/TL
B10-B10	1

10 PC: 6x7, 8x9, 10x11, 12x13, 14x15, 16x17, 18x19, 20x22, 21x23, 24x26 mm

KOD NO	FİYAT/TL
B10-B10/2	1

10 PC: 6x7, 8x9, 10x11, 12x13, 14x15, 16x17, 18x19, 20x22, 24x27, 30x32 mm

KOD NO	FİYAT/TL
B10-B12	1

12 PC: 6x7, 8x9, 10x11, 12x13, 14x15, 16x17, 18x19, 20x22, 21x23, 24x26, 25x28, 30x32 mm



B10-P1212 Parça Çatal İki Ağız Anahtar Takımı (Kısa Tip)-
Plastik Klipsli



KOD NO		FİYAT/TL
B10-P12	1	
12 PC: 6x7, 8x9, 10x11, 12x13, 14x15, 16x17, 18x19, 20x22, 21x23, 24x26, 25x28, 30x32 mm		

B09 Serisi

Çatal İki Ağız Anahtarlar (Uzun Tip)



KOD NO				FİYAT/TL
B09-0555	5x 5.5	120	12	
B09-0607	6x 7	120	12	
B09-0809	8x 9	140	12	
B09-0810	8x10	145	12	
B09-1011	10x11	150	12	
B09-1012	10x12	155	12	
B09-1013	10x13	170	12	
B09-1213	12x13	170	12	
B09-1214	12x14	170	12	
B09-1317	13x17	200	12	
B09-1415	14x15	185	12	
B09-1417	14x17	200	12	
B09-1617	16x17	200	12	
B09-1719	17x19	210	12	
B09-1819	18x19	220	12	
B09-1922	19x22	230	12	
B09-2022	20x22	235	12	
B09-2123	21x23	245	6	
B09-2224	22x24	250	6	
B09-2426	24x26	265	6	
B09-2427	24x27	265	6	
B09-2528	25x28	275	6	
B09-2732	27x32	300	6	
B09-3032	30x32	300	6	
B09-3236	32x36	325	6	
B09-3336	33x36	300	6	
B09-3641	36x41	360	3	
B09-4146	41x46	400	1	
B09-4650	46x50	450	1	

 Teşhir kartlı sipariş için = Ürün Kodu + X  Kart Bedeli
6

B09-R Serisi

Çatal İki Ağız Anahtar Takımları (Uzun Tip)- Bez Çantalı



KOD NO		FİYAT/TL
B09-R08	1	
8 PC: 6x7, 8x9, 10x11, 12x13, 14x15, 16x17, 18x19, 20x22 mm		
B09-R12	1	
12 PC: 6x7, 8x9, 10x11, 12x13, 14x15, 16x17, 18x19, 20x22, 21x23, 24x26, 25x28, 30x32 mm		

B09-B Serisi

Çatal İki Ağız Anahtar Takımları (Uzun Tip)- Karton Kutulu



KOD NO		FİYAT/TL
B09-B06	1	
6 PC: 6x7, 8x9, 10x11, 12x13, 14x15, 16x17 mm		
B09-B08	1	
8 PC: 6x7, 8x9, 10x11, 12x13, 14x15, 16x17, 18x19, 20x22 mm		
B09-B10	1	
10 PC: 6x7, 8x9, 10x11, 12x13, 14x15, 16x17, 18x19, 20x22, 21x23, 24x26 mm		
B09-B10/2	1	
10 PC: 6x7, 8x9, 10x11, 12x13, 14x15, 16x17, 18x19, 20x22, 24x27, 30x32 mm		
B09-B12	1	
12 PC: 6x7, 8x9, 10x11, 12x13, 14x15, 16x17, 18x19, 20x22, 21x23, 24x26, 25x28, 30x32 mm		



B09-P1212 Parça Çatal İki Ağız Anahtar Takımı (Uzun Tip)-
Plastik Klipsli

KOD NO		FİYAT/TL
B09-P12	1	
12 PC: 6x7, 8x9, 10x11, 12x13, 14x15, 16x17, 18x19, 20x22, 21x23, 24x26, 25x28, 30x32 mm		

B09A Serisi

Çatal İki Ağız Anahtarlar - SAE



KOD NO				FİYAT/TL
B09A-0102	1/4x5/16	123	6	
B09A-0203	5/16x3/8	142	6	
B09A-0304	3/8x7/16	158	6	
B09A-0405	7/16x1/2	171	6	
B09A-0506	1/2x9/16	175	6	
B09A-0607	9/16x5/8	187	6	
B09A-0708	5/8x11/16	201	6	
B09A-0709	5/8x3/4	201	6	
B09A-0809	11/16x3/4	220	6	
B09A-0810*	11/16x13/16	235	6	
B09A-0911	3/4x7/8	237	6	
B09A-1011	13/16x7/8	238	6	
B09A-1213	15/16x1	265	6	
B09A-1315	1x1-1/8	279	6	
B09A-1415	1-1/16x1-1/8	300	6	
B09A-1417	1-1/16x1-1/4	300	6	

* Stoklarla sınırlıdır

B09A-R10

10 Parça Çatal İki Ağız Anahtar Takımı (Bez Çantalı) - SAE





KOD NO		FİYAT/TL
B09A-R10	1	
10 PC: 1/4x5/16, 5/16x3/8, 7/16x1/2, 1/2x9/16, 9/16x5/8, 5/8x3/4, 11/16x3/4, 13/16x7/8, 15/16x1, 1-1/16x1-1/8 inch		

B09SA Serisi

Açılı Ağız Anahtarlar (Kısa Tip) - SAE



KOD NO				FİYAT/TL
B09SA-0732	7/32	75	6	
B09SA-1564	15/64	80	6	
B09SA-0104	1/4	80	6	
B09SA-0932	9/32	80	6	
B09SA-0516	5/16	90	6	
B09SA-1132	11/32	90	6	
B09SA-0308	3/8	100	6	
B09SA-0716	7/16	100	6	
B09SA-0102	1/2	120	6	
B09SA-0916	9/16	120	6	

B09SA-R09

Açılı Ağız Anahtar Takımı (Kısa Tip) - SAE



KOD NO		FİYAT/TL
B09SA-R09	1	
9 PC: 7/32, 15/64, 1/4, 9/32, 5/16, 11/32, 3/8, 7/16, 1/2 inch		

2 Anahtarlar ve Allenler

B14 Serisi

Yıldız İki Ağız Anahtarlar



KOD NO	Ømm	mm	mm	FİYAT/TL
B14-0607	6x7	175	12	
B14-0809	8x9	190	12	
B14-1011	10x11	210	12	
B14-1213	12x13	230	12	
B14-1415	14x15	250	12	
B14-1617	16x17	275	12	
B14-1819	18x19	300	12	
B14-2022	20x22	335	12	
B14-2123	21x23	340	6	
B14-2426	24x26	345	6	
B14-2427	24x27	345	6	
B14-2528	25x28	360	6	
B14-3032	30x32	370	6	
B14-3641	36x41	470	3	

B14-R Serisi

Yıldız İki Ağız Anahtar Takımları (Bez Çantalı)



KOD NO	FİYAT/TL
B14-R08 8 PC: 6x7, 8x9, 10x11, 12x13, 14x15, 16x17, 18x19, 20x22 mm	1
B14-R12 12 PC: 6x7, 8x9, 10x11, 12x13, 14x15, 16x17, 18x19, 20x22, 21x23, 24x26, 25x28, 30x32 mm	1

B14-B Serisi

Yıldız İki Ağız Anahtar Takımları (Karton Kutulu)



KOD NO	FİYAT/TL
B14-B06 6 PC: 6x7, 8x9, 10x11, 12x13, 14x15, 16x17 mm	1
B14-B08 8 PC: 6x7, 8x9, 10x11, 12x13, 14x15, 16x17, 18x19, 20x22 mm	1
B14-B10/2 10 PC: 6x7, 8x9, 10x11, 12x13, 14x15, 16x17, 18x19, 20x22, 24x27, 30x32 mm	1
B14-B12 12 PC: 6x7, 8x9, 10x11, 12x13, 14x15, 16x17, 18x19, 20x22, 21x23, 24x26, 25x28, 30x32 mm	1

B17 Serisi

Dış TORX Anahtarlar



KOD NO	Ømm	mm	FİYAT/TL
B17-0608	E06xE08	110	6
B17-1012	E10xE12	140	6
B17-1418	E14xE18	180	6
B17-2024	E20xE24	225	6

Kart Bedeli
Teşhir kartlı sipariş için = Ürün Kodu + X 6

B17-B04

4 Parça Dış TORX Anahtar Takımı



KOD NO	FİYAT/TL
B17-B04 4 PC: E6xE8, E10xE12, E14xE18, E20xE24	1

B19 Serisi

Rakor Anahtarlar



KOD NO	Ømm	mm	FİYAT/TL
B19-0810	8x10	141	6
B19-0911	9x11	151	6
B19-1011	10x11	161	6
B19-1113	11x13	175	6
B19-1214	12x14	175	6
B19-1719	17x19	210	6
B19-1922	19x22	230	6
B19-2427	24x27	295	6

Kart Bedeli
Teşhir kartlı sipariş için = Ürün Kodu + X 6

B19-B06

6 Parça Rakor Anahtar Takımı



KOD NO	FİYAT/TL
B19-B06 6 PC: 8x10, 10x11, 11x13, 12x14, 17x19, 19x22 mm	1

B20 Serisi

Yıldız İki Ağız Yarım Ay Anahtarlar



KOD NO	Ømm	mm	FİYAT/TL
B20-1012	10x12	143	6
B20-1113	11x13	143	6
B20-1315	13x15	166	6
B20-1317	13x17	183	6
B20-1417	14x17	183	6
B20-1922	19x22	235	6

B21-B Serisi

Kurbağacık Anahtarlar (Fosfat Kaplı-PVC Daldırma Saplı)



KOD NO	mm "	mm		FİYAT/TL
B21-150B	150 - 6"	20	6	
B21-200B	200 - 8"	25	6	
B21-250B	250 - 10"	30	6	
B21-300B	300 - 12"	35	6	
B21-375B	375 - 15"	45	2	

B23 Serisi

Çatal Ağız Çakma Anahtarlar



KOD NO	mm	mm		FİYAT/TL
B23-24	24	165	1	
B23-27	27	180	1	
B23-30	30	190	1	
B23-32	32	190	1	
B23-36	36	210	1	
B23-41	41	230	1	
B23-46	46	250	1	
B23-50	50	275	1	
B23-55	55	305	1	
B23-60	60	315	1	
B23-65	65	335	1	
B23-70	70	370	1	
B23-75	75	395	1	
B23-80	80	400	1	
B23-85	85	400	1	
B23-90	90	445	1	
B23-95	95	445	1	
B23-100	100	485	1	

B24 Serisi

Yıldız Ağız Çakma Anahtarlar



KOD NO	mm	mm		FİYAT/TL
B24-24	24	165	1	
B24-27	27	185	1	
B24-30	30	185	1	
B24-32	32	185	1	
B24-36	36	205	1	
B24-41	41	225	1	
B24-46	46	235	1	
B24-50	50	250	1	
B24-55	55	265	1	
B24-60	60	275	1	
B24-65	65	305	1	
B24-70	70	335	1	
B24-75	75	335	1	
B24-80	80	360	1	
B24-90	90	395	1	
B24-95	95	395	1	
B24-100	100	425	1	

B21-C Serisi

Kurbağacık Anahtarlar (Krom Kaplı-PVC Daldırma Saplı)



KOD NO	mm "	mm		FİYAT/TL
B21-150C	150 - 6"	20	6	
B21-200C	200 - 8"	25	6	
B21-250C	250 - 10"	30	6	
B21-300C	300 - 12"	35	6	
B21-375C	375 - 15"	45	2	

B27T Serisi

Kovan İki Ağız Anahtarlar (Boru Tipi)



KOD NO	mm	mm		FİYAT/TL
B27T-0607	6x 7	100	6	
B27T-0809	8x 9	100	6	
B27T-1011	10x11	115	6	
B27T-1213	12x13	135	6	
B27T-1415	14x15	135	6	
B27T-1617	16x17	145	6	
B27T-1819	18x19	150	6	
B27T-2022	20x22	160	6	
B27T-2123	21x23	160	6	
B27T-2426	24x26	175	6	
B27T-2528	25x28	190	6	
B27T-3032	30x32	190	6	

B27T-B Serisi

Kovan İki Ağız Anahtar Takımları (Boru Tipi)



KOD NO		FİYAT/TL
B27T-B08	1	
8 PC: 6x7, 8x9, 10x11, 12x13, 14x15, 16x17, 18x19, 20x22 mm		
B27T-B12	1	
12 PC: 6x7, 8x9, 10x11, 12x13, 14x15, 16x17, 18x19, 20x22, 21x23, 24x26, 25x28, 30x32 mm		

B21W-200B

Kurbağacık Anahtar - Extra Geniş Çeneli



KOD NO	mm "	mm		FİYAT/TL
B21W-200B	200 - 8"	38	6	

B27T-.B Serisi

Kovan Anahtar Kolları (B27T Serisi için)



KOD NO	mm	mm		FİYAT/TL
B27T-06B	6 - 11	160	6	
B27T-08B	12 - 15	180	6	
B27T-10B	16 - 17	200	6	
B27T-12B	18 - 22	250	6	
B27T-14B	21 - 26	320	6	
B27T-16B	25 - 32	400	6	
B27T-2B	16 - 22	210	6	

B27 Serisi

Kovan İki Ağız Anahtarlar (Dövme)



KOD NO	mm	mm		FİYAT/TL
B27-2022	20x22	175	6	
B27-2123	21x23	185	6	
B27-2224	22x24	185	6	
B27-2426	24x26	190	6	
B27-2427	24x27	190	6	
B27-2528	25x28	205	6	
B27-3032	30x32	210	6	

2 Anahtarlar ve Allenler

B28 Serisi

Pipo İki Ağız L Tipi Anahtarlar



KOD NO	Ømm	mm	📦	FİYAT/TL
B28-06	6	110	6	
B28-07	7	110	6	
B28-08	8	115	6	
B28-09	9	115	6	
B28-10	10	130	6	
B28-11	11	140	6	
B28-12	12	150	6	
B28-13	13	155	6	
B28-14	14	165	6	
B28-15	15	170	6	
B28-16	16	180	6	
B28-17	17	190	6	
B28-18	18	200	6	
B28-19	19	210	6	
B28-22	22	230	6	

B28-B08

8 Parça Pipo İki Ağız L Tipi Anahtar Takımı



KOD NO	📦	FİYAT/TL
B28-B08	1	

8 PC: 8, 10, 11, 12, 13, 14, 17, 19 mm

B32 Serisi

T Saplı Oynar Başlı Lokma Anahtarlar



KOD NO	Ømm	mm	📦	FİYAT/TL
B32-06	6	396	6	
B32-07	7	396	6	
B32-08	8	396	6	
B32-09	9	395	6	
B32-10	10	395	6	
B32-11	11	395	6	
B32-12	12	395	6	
B32-13	13	500	6	
B32-14	14	500	6	
B32-15	15	500	6	
B32-16	16	500	6	
B32-17	17	500	6	
B32-18	18	500	6	
B32-19	19	500	6	

K20 Serisi

T Saplı Lokma Anahtarlar



KOD NO	Ømm	mm	📦	FİYAT/TL
K20-06	6	230	6	
K20-07	7	230	6	
K20-08	8	230	6	
K20-09	9	230	6	
K20-10	10	230	6	
K20-11	11	230	6	
K20-12	12	230	6	
K20-13	13	230	6	

K20-B06

6 Parça T Saplı Lokma Anahtar Takımı

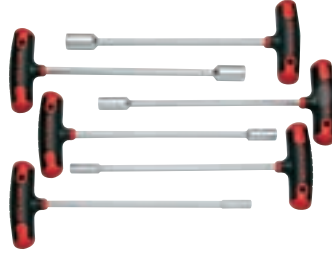

KOD NO	📦	FİYAT/TL
K20-B06	1	

6 PC: 6, 7, 8, 10, 12, 13 mm

K20-L Serisi

T Saplı Lokma Anahtarlar (Uzun Süngü)



KOD NO	Ømm	mm	📦	FİYAT/TL
K20-08L	8	350	6	
K20-10L	10	350	6	
K20-13L	13	350	6	

B30 Serisi

İki Ağız Oynar Başlı Lokma Anahtarlar



KOD NO	Ømm	mm	📦	FİYAT/TL
B30-0810	8x10	185	6	
B30-1011	10x11	200	6	
B30-1213	12x13	220	6	
B30-1415	14x15	242	6	
B30-1617	16x17	255	6	
B30-1819	18x19	275	6	

L Serisi / mm

L Allen Anahtarlar (Kısa Tip)



KOD NO	Ømm	Ø"	mm	📦	FİYAT/TL
L/0028	0.7	0.028	35	12	
L/0035	0.9	0.035	35	12	
L/1.3	1.3	-	41	12	
L/1.5	1.5	-	45	12	
L/2	2	-	51	12	
L/2.5	2.5	-	58	12	
L/2.5B	2.5	-	58	12	
L/3	3	-	65	12	
L/3.5	3.5	-	69	12	
L/4	4	-	73	12	
L/4.5	4.5	-	77	12	
L/5	5	-	83	12	
L/6	6	-	95	12	
L/7	7	-	99	12	
L/8	8	-	106	12	
L/9	9	-	111	12	
L/10	10	-	121	12	
L/11	11	-	125	12	
L/12	12	-	134	12	
L/13	13	-	145	12	
L/14	14	-	154	12	
L/16	16	-	166	12	
L/17	17	-	175	6	
L/19	19	-	198	6	
L/22	22	-	220	3	
L/24	24	-	248	3	
L/27	27	-	277	1	
L/32	32	-	345	1	

Teşhir kartlı sipariş için = Ürün Kodu + X
1.3 - 10 mm arasındaki ürünler için mevcuttur

📦 Kart Bedeli
6

LT/7

7 Parça L Allen Anahtar Takımı (Kısa Tip)



KOD NO	📦	FİYAT/TL
LT/7	6	

7 PC: 1.5, 2, 2.5, 3, 4, 5, 6 mm

LT/9

9 Parça L Allen Anahtar Takımı (Kısa Tip)



KOD NO		FİYAT/TL
LT/9	6	
9 PC: 1.5, 2, 2.5, 3, 4, 5, 6, 8, 10 mm		

LT/9D

LT/9 L Allen Anahtar Takımı Teşhir Seti



KOD NO		FİYAT/TL
LT/9D	1	
12x LT/9		

LT/12

12 Parça L Allen Anahtar Takımı (Kısa Tip)



KOD NO		FİYAT/TL
LT/12	6	
12 PC: 1.5, 2, 2.5, 3, 3.5, 4, 5, 6, 7, 8, 10, 12 mm		

LT/12D

LT/12 L Allen Anahtar Takımı Teşhir Seti



KOD NO		FİYAT/TL
LT/12D	1	
12x LT/12		

800 Serisi

L Allen Anahtarlar (Uzun Tip)



KOD NO				FİYAT/TL
815	1.5	90	12	•
802	2	101	12	•
825	2.5	114	12	•
803	3	127	12	•
835	3.5	138	12	•
804	4	144	12	•
805	5	164	12	•
806	6	185	12	•
807	7	194	12	•
808	8	206	12	•
810	10	232	12	•
812	12	261	12	•
814	14	261	12	•
817	17	261	6	•
819	19	261	6	•

	Kart Bedeli
Teşhir kartlı sipariş için = Ürün Kodu + X	6

LT7/800

7 Parça L Allen Anahtar Takımı (Uzun Tip)



KOD NO		FİYAT/TL
LT7/800	6	
7 PC: 1.5, 2, 2.5, 3, 4, 5, 6 mm		

LT/800

9 Parça L Allen Anahtar Takımı (Uzun Tip)



KOD NO		FİYAT/TL
LT/800	6	
9 PC: 1.5, 2, 2.5, 3, 4, 5, 6, 8, 10 mm		

LT/800D

LT/800 L Allen Anahtar Takımı Teşhir Seti



KOD NO		FİYAT/TL
LT/800D	1	
12x LT/800		

LT12/800

12 Parça L Allen Anahtar Takımı (Uzun Tip)



KOD NO		FİYAT/TL
LT12/800	6	
12 PC: 1.5, 2, 2.5, 3, 3.5, 4, 5, 6, 7, 8, 10, 12 mm		

900 Serisi

Topbaşlı L Allen Anahtarlar (Uzun Tip)



KOD NO				FİYAT/TL
915	1.5	90	12	•
902	2	100	12	•
925	2.5	112	12	•
903	3	127	12	•
935	3.5	139	12	•
904	4	143	12	•
905	5	164	12	•
906	6	184	12	•
907	7	194	12	•
908	8	206	12	•
910	10	232	12	•
912	12	260	12	•

	Kart Bedeli
Teşhir kartlı sipariş için = Ürün Kodu + X	6

LT7/900

7 Parça Topbaşlı L Allen Anahtar Takımı (Uzun Tip)



KOD NO		FİYAT/TL
LT7/900	6	
7 PC: 1.5, 2, 2.5, 3, 4, 5, 6 mm		

2 Anahtarlar ve Allenler

LT/900

9 Parça Topbaşlı L Allen Anahtar Takımı (Uzun Tip)



KOD NO		FİYAT/TL
LT/900	6	
9 PC: 1.5, 2, 2.5, 3, 4, 5, 6, 8, 10 mm		

LT/900D

LT/900 Topbaşlı L Allen Anahtar Takımı Teşhir Seti



KOD NO		FİYAT/TL
LT/900D	1	
12x LT/900		

LT/900C

9 Parça Topbaşlı L Allen Anahtar Takımı (Uzun Tip - Renk Kodlu)

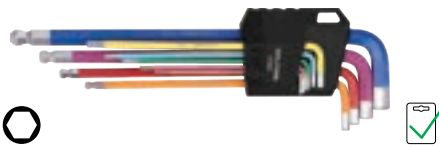

KOD NO		FİYAT/TL
LT/900C	6	
9 PC: 1.5, 2, 2.5, 3, 4, 5, 6, 8, 10 mm		

LT12/900

12 Parça Topbaşlı L Allen Anahtar Takımı (Uzun Tip)



KOD NO		FİYAT/TL
LT12/900	6	
12 PC: 1.5, 2, 2.5, 3, 3.5, 4, 5, 6, 7, 8, 10, 12 mm		

L Serisi / SAE

L Allen Anahtarlar (Kısa Tip) - SAE



KOD NO					FİYAT/TL
L/0028	0.028	0.7	35	12•	
L/0035	0.035	0.9	35	12•	
L/0364	3/64	-	38	12•	
L/0050	0.05	-	41	12•	
L/0116	1/16	-	47	12•	
L/0564	5/64	-	52	12•	
L/0332	3/32	-	58	12•	
L/0764	7/64	-	58	12•	
L/0108	1/8	-	66	12•	
L/0964	9/64	-	66	12•	
L/0532	5/32	-	71	12•	
L/0316	3/16	-	83	12•	
L/0732	7/32	-	88	12•	
L/0104	1/4	-	94	12•	
L/0516	5/16	-	105	12•	
L/0308	3/8	-	118	12•	
L/0716	7/16	-	130	12•	
L/0102	1/2	-	141	12	
L/0916	9/16	-	150	6	
L/0508	5/8	-	172	6	
L/0304	3/4	-	179	6	

LT/9AF

9 Parça L Allen Anahtar Takımı (Kısa Tip) - SAE



KOD NO		FİYAT/TL
LT/9AF	6	
9 PC: 1/16, 5/64, 3/32, 1/8, 5/32, 3/16, 1/4, 5/16, 3/8 inch		

LT/13AF

13 Parça L Allen Anahtar Takımı (Kısa Tip) - SAE



KOD NO		FİYAT/TL
LT/13AF	6	
13 PC: 0.05, 1/16, 5/64, 3/32, 7/64, 1/8, 9/64, 5/32, 3/16, 7/32, 1/4, 5/16, 3/8 inch		

800 Serisi / SAE

L Allen Anahtarlar (Uzun Tip) - SAE



KOD NO				FİYAT/TL
80050	0.05	80	12•	
80116	1/16	92	12•	
80564	5/64	102	12•	
80332	3/32	114	12•	
80764	7/64	126	12•	
80108	1/8	129	12•	
80964	9/64	137	12•	
80532	5/32	144	12•	
80316	3/16	165	12•	
80732	7/32	183	12•	
80104	1/4	186	12•	
80516	5/16	205	12•	
80308	3/8	230	12•	

LT/800AF

9 Parça L Allen Anahtar Takımı (Uzun Tip) - SAE



KOD NO		FİYAT/TL
LT/800AF	6	
9 PC: 1/16, 5/64, 3/32, 1/8, 5/32, 3/16, 1/4, 5/16, 3/8 inch		

LT13/800AF

13 Parça L Allen Anahtar Takımı (Uzun Tip) - SAE



KOD NO		FİYAT/TL
LT13/800AF	6	
13 PC: 0.05, 1/16, 5/64, 3/32, 7/64, 1/8, 9/64, 5/32, 3/16, 7/32, 1/4, 5/16, 3/8 inch		

900 Serisi / SAE

Topbaşlı L Allen Anahtarlar (Uzun Tip) - SAE



KOD NO				FİYAT/TL
90050	0.05	80	12•	
90116	1/16	92	12•	
90564	5/64	102	12•	
90332	3/32	114	12•	
90764	7/64	126	12•	
90108	1/8	129	12•	
90964	9/64	137	12•	
90532	5/32	144	12•	
90316	3/16	165	12•	
90732	7/32	183	12•	
90104	1/4	186	12•	
90516	5/16	205	12•	
90308	3/8	230	12•	

700 Serisi

TORX L Anahtarlar (Kısa Tip)



KOD NO				FİYAT/TL
705	T5	44	12•	
706	T6	44	12•	
707	T7	47	12•	
708	T8	49	12•	
709	T9	51	12•	
710	T10	54	12•	
715	T15	56	12•	
720	T20	61	12•	
725	T25	65	12•	
727	T27	69	12•	
730	T30	75	12•	
740	T40	82	12•	
745	T45	86	12•	
750	T50	109	12•	

700L Serisi

TORX L Anahtarlar (Uzun Tip)



KOD NO				FİYAT/TL
705L	T5	73	12•	
706L	T6	73	12•	
707L	T7	77	12•	
708L	T8	84	12•	
709L	T9	99	12•	
710L	T10	103	12•	
715L	T15	115	12•	
720L	T20	129	12•	
725L	T25	145	12•	
727L	T27	165	12•	
730L	T30	176	12•	
740L	T40	187	12•	
745L	T45	208	12•	

LT/900AF

9 Parça Topbaşlı L Allen Anahtar Takımı (Uzun Tip) - SAE



KOD NO		FİYAT/TL
LT/900AF	6	
9 PC: 1/16, 5/64, 3/32, 1/8, 5/32, 3/16, 1/4, 5/16, 3/8 inch		

LT/700

8 Parça TORX L Anahtar Takımı (Kısa Tip)



KOD NO		FİYAT/TL
LT/700	6	
8 PC: T9, T10, T15, T20, T25, T27, T30, T40		

LT/700L

8 Parça TORX L Anahtar Takımı (Uzun Tip)



KOD NO		FİYAT/TL
LT/700L	6	
8 PC: T9, T10, T15, T20, T25, T27, T30, T40		

LT13/900AF

13 Parça Topbaşlı L Allen Anahtar Takımı (Uzun Tip) - SAE



KOD NO		FİYAT/TL
LT13/900AF	6	
13 PC: 0.05, 1/16, 5/64, 3/32, 7/64, 1/8, 9/64, 5/32, 3/16, 7/32, 1/4, 5/16, 3/8 inch		

LT13/700

13 Parça TORX L Anahtar Takımı (Kısa Tip)



KOD NO		FİYAT/TL
LT13/700	6	
13 PC: T5, T6, T7, T8, T9, T10, T15, T20, T25, T27, T30, T40, T45		

LT13/700L

13 Parça TORX L Anahtar Takımı (Uzun Tip)



KOD NO		FİYAT/TL
LT13/700L	6	
13 PC: T5, T6, T7, T8, T9, T10, T15, T20, T25, T27, T30, T40, T45		

2 Anahtarlar ve Allenler

700TL Serisi

Delikli TORX L Anahtarlar (Uzun Tip)



KOD NO		mm		FİYAT/TL
709TL	T9	99	12•	
710TL	T10	103	12•	
715TL	T15	115	12•	
720TL	T20	129	12•	
725TL	T25	145	12•	
727TL	T27	166	12•	
730TL	T30	176	12•	
740TL	T40	187	12•	

LT/700TL

8 Parça Delikli TORX L Anahtar Takımı (Uzun Tip)



KOD NO		FİYAT/TL
LT/700TL	6	

8 PC: T9, T10, T15, T20, T25, T27, T30, T40

700B Serisi

Topbaşlı TORX L Anahtarlar (Uzun Tip)



KOD NO		mm		FİYAT/TL
709B	T9	99	12•	
710B	T10	103	12•	
715B	T15	115	12•	
720B	T20	130	12•	
725B	T25	145	12•	
727B	T27	166	12•	
730B	T30	176	12•	
740B	T40	187	12•	

LT/700B

8 Parça Topbaşlı TORX L Anahtar Takımı (Uzun Tip)



KOD NO		FİYAT/TL
LT/700B	6	

8 PC: T9, T10, T15, T20, T25, T27, T30, T40

700IPR Serisi

5 Köşe Delikli TORX L Anahtarlar (Uzun Tip)



KOD NO		mm		FİYAT/TL
709IPR	IPR09	99	12•	
710IPR	IPR10	103	12•	
715IPR	IPR15	115	12•	
720IPR	IPR20	130	12•	
725IPR	IPR25	145	12•	
727IPR	IPR27	166	12•	
730IPR	IPR30	176	12•	
740IPR	IPR40	187	12•	

LT/700IPR

8 Parça 5 Köşe Delikli TORX L Anahtar Takımı (Uzun Tip)



KOD NO		FİYAT/TL
LT/700IPR	6	

8 PC: IPR09, IPR10, IPR15, IPR20, IPR25, IPR27, IPR30, IPR40

740 Serisi

XZN L Anahtarlar



KOD NO		mm		FİYAT/TL
740/M05	M05	81	12•	
740/M06	M06	90	12•	
740/M08	M08	100	12•	
740/M10	M10	112	12•	
740/M12	M12	129	12•	
740/M14	M14	152	12•	

LT/740

5 Parça XZN L Anahtar Takımı



KOD NO		FİYAT/TL
LT/740	6	

5 PC: M05, M06, M08, M10, M12

LT/9CP

18 Pç. Kombo L Allen Anahtar Tk. (Kısa Tip) - Metrik/SAE



KOD NO		FİYAT/TL
LT/9CP	6	

2 PC: LT/9, LT/9AF

LT/800CP

18 Parça Kombo L Allen Anahtar Takımı (Uzun Tip) - Metrik / SAE



KOD NO		FİYAT/TL
LT/800CP	6	

2 PC: LT/800, LT/800AF

LT/900CP

18 Parça Kombo Topbaşlı L Allen Anahtar Takımı (Uzun Tip) - Metrik/SAE



KOD NO		FİYAT/TL
LT/900CP	6	

2 PC: LT/900, LT/900AF

LT27/800CP

27 Parça Kombo L Allen Anahtar Takımı
(Uzun Tip) - Metrik/SAE



KOD NO	FİYAT/TL
LT27/800CP	1
800/Metrik 12 PC: 1,5, 2, 2,5, 3, 3,5, 4, 5, 6, 7, 8, 10, 12 mm	
800/SAE 12 PC: 1/16, 5/64, 3/32, 7/64, 1/8, 9/64, 5/32, 3/16, 7/32, 1/4, 5/16, 3/8 inch	
L/SAE 3 PC: 0,028, 0,035, 0,050 inch	

LT27/900CP

27 Parça Kombo Topbaşlı L Allen Anahtar Takımı
(Uzun Tip) - Metrik/SAE



KOD NO	FİYAT/TL
LT27/900CP	1
900/Metrik 12 PC: 1,5, 2, 2,5, 3, 3,5, 4, 5, 6, 7, 8, 10, 12 mm	
900/SAE 12 PC: 1/16, 5/64, 3/32, 7/64, 1/8, 9/64, 5/32, 3/16, 7/32, 1/4, 5/16, 3/8 inch	
L/SAE 3 PC: 0,028, 0,035, 0,050 inch	

K10T Serisi

T Allen Anahtarlar (3 Uçlu)



KOD NO	Ømm	mm	FİYAT/TL
K10T-030	3	150	12
K10T-040	4	175	12
K10T-050	5	195	12
K10T-060	6	215	12

K10 Serisi

T Saplı Allen Anahtarlar



KOD NO	Ømm	mm	FİYAT/TL
K10-020-100	2	100	12
K10-025-100	2.5	100	12
K10-030-100	3	100	12
K10-040-150	4	150	12
K10-050-150	5	150	12
K10-060-200	6	200	12
K10-070-200	7	200	12
K10-080-200	8	200	12
K10-100-200	10	200	12

K99-10-06

6 Parça T Saplı Allen Anahtar Takımı



KOD NO	FİYAT/TL
K99-10-06	1
6 PC: 2,5, 3, 4, 5, 6, 8 mm	

K99-10-M08

8 Parça T Saplı Allen Anahtar Takımı (Metal Stand ile)



KOD NO	FİYAT/TL
K99-10-M08	1
8 PC: 2, 2,5, 3, 4, 5, 6, 8, 10 mm	
K99-10-ME	Boş Metal Stand (K10 ve K11 Serisi için)

K11 Serisi

T Saplı Topbaşlı Allen Anahtarlar



KOD NO	Ømm	mm	FİYAT/TL
K11-020-100	2	100	12
K11-025-100	2.5	100	12
K11-030-100	3	100	12
K11-040-150	4	150	12
K11-050-150	5	150	12
K11-060-200	6	200	12
K11-080-200	8	200	12
K11-100-200	10	200	12

K99-11-M08

8 Parça T Saplı Topbaşlı Anahtar Takımı
(Metal Stand ile)

yeni



KOD NO	FİYAT/TL
K99-11-M08	1
8 PC: 2, 2,5, 3, 4, 5, 6, 8, 10 mm	
K99-10-ME	Boş Metal Stand (K10 ve K11 Serisi için)

K10A Serisi

T Saplı Allen Anahtarlar - SAE



KOD NO	Ømm	mm	FİYAT/TL
K10A-0564	5/64	100	12
K10A-0332	3/32	100	12
K10A-0764	7/64	100	12
K10A-0108	1/8	100	12
K10A-0964	9/64	100	12
K10A-0532	5/32	150	12
K10A-0316	3/16	150	12
K10A-0732	7/32	150	12
K10A-0104	1/4	200	12
K10A-0516	5/16	200	12
K10A-0308	3/8	200	12

K99-10A-M10

10 Parça T Saplı Allen Anahtar Takımı - SAE (Metal Stand ile)



KOD NO	FİYAT/TL
K99-10A-M10	1
10 PC: 3/32, 7/64, 1/8, 9/64, 5/32, 3/16, 7/32, 1/4, 5/16, 3/8 inch	
K99-10A-ME	Boş Metal Stand (K10A Serisi için)

2 Anahtarlar ve Allenler

K12 Serisi

T Saplı TORX Anahtarlar



KOD NO				FİYAT/TL
K12-009-100	T9	100	12	
K12-010-100	T10	105	12	
K12-015-100	T15	105	12	
K12-020-150	T20	155	12	
K12-025-150	T25	155	12	
K12-027-150	T27	155	12	
K12-030-150	T30	160	12	
K12-040-150	T40	160	12	

K99-12-06

6 Parça T Saplı TORX Anahtar Takımı



KOD NO		FİYAT/TL
K99-12-06	1	

6 PC: T10, T15, T20, T25, T30, T40

K99-12-M07

7 Parça T Saplı TORX Anahtar Takımı (Metal Stand ile)



KOD NO		FİYAT/TL
K99-12-M07	1	

7 PC: T10, T15, T20, T25, T27, T30, T40

K99-12-ME Boş Metal Stand (K12 Serisi için) 1

K99-F1

8 Parça Çakı Tipi Allen Anahtar Seti

Yeni



KOD NO		FİYAT/TL
K99-F1	10	

8 PC: 1.5, 2, 2.5, 3, 4, 5, 6, 8 mm

K99-F2

8 Parça Çakı Tipi Allen Anahtar Seti - SAE

Yeni



KOD NO		FİYAT/TL
K99-F2	10	

8 PC: 3/32, 7/64, 1/8, 9/64, 5/32, 3/16, 7/32, 1/4 inch

K99-F3

8 Parça Çakı Tipi TORX Anahtar Seti

Yeni



KOD NO		FİYAT/TL
K99-F3	10	

8 PC: T9, T10, T15, T20, T25, T27, T30, T40

K99-F2M

9 Parça Çakı Tipi Allen Anahtar Seti No.1 (Metal Kasa) - SAE



KOD NO		FİYAT/TL
K99-F2M	10	

9 PC: 0.05, 1/16, 5/64, 3/32, 7/64, 1/8, 9/64, 5/32, 3/16 inch

K99-F2M/2

9 Parça Çakı Tipi Allen Anahtar Seti No. 2 (Metal Kasa) - SAE



KOD NO		FİYAT/TL
K99-F2M/2	10	

9 PC: 5/64, 3/32, 7/64, 1/8, 9/64, 5/32, 3/16, 7/32, 1/4 inch

F37 Serisi

P Saplı TORX Bayrak Tornavidalar



KOD NO				FİYAT/TL
F37-06	T06	40	12	
F37-07	T07	40	12	
F37-08	T08	40	12	
F37-09	T09	40	12	
F37-10	T10	40	12	
F37-15	T15	40	12	
F37-20	T20	40	12	

F37-P06

6 Parça TORX Bayrak Tornavida Seti

Yeni



KOD NO		FİYAT/TL
F37-P06	1	

6 PC: T6, T7, T8, T9, T10, T15

F37-IP Serisi

P Saplı TORX PLUS Bayrak Tornavidalar



KOD NO				FİYAT/TL
F37-IP08	IP08	40	12	
F37-IP09	IP09	40	12	
F37-IP10	IP10	40	12	
F37-IP15	IP15	40	12	

3 Lokma Anahtarlar ve Aksesuarları

49 | 74



C02-H Serisi

1/4" 6 Köşe Lokma Anahtarlar

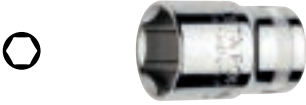
6.3
1/4"

KOD NO	mm	mm	FİYAT/TL
C02-H040	4	25	12•
C02-H045	4.5	25	12•
C02-H050	5	25	12•
C02-H055	5.5	25	12•
C02-H060	6	25	12•
C02-H070	7	25	12•
C02-H080	8	25	12•
C02-H090	9	25	12•
C02-H100	10	25	12•
C02-H110	11	25	12•
C02-H120	12	25	12•
C02-H130	13	25	12•
C02-H140	14	25	12•
C02-H150	15	25	6•



Teşhir kartlı sipariş için = Ürün Kodu + X



Kart Bedeli

6

C02A-H Serisi

1/4" 6 Köşe Lokma Anahtarlar - SAE

6.3
1/4"

KOD NO	inch	mm	FİYAT/TL
C02A-H0108	1/8	25	12•
C02A-H0532	5/32	25	12•
C02A-H0316	3/16	25	12•

C02A-B Serisi

1/4" 12 Köşe (Yıldız) Lokma Anahtarlar - SAE

6.3
1/4"

KOD NO	inch	mm	FİYAT/TL
C02A-B0316	3/16	25	6•
C02A-B0732	7/32	25	6•
C02A-B0104	1/4	25	6•
C02A-B0932	9/32	25	6•
C02A-B0516	5/16	25	6•
C02A-B1132	11/32	25	6•
C02A-B0308	3/8	25	6•
C02A-B0716	7/16	25	6•
C02A-B0102	1/2	25	6•
C02A-B0916	9/16	25	6•

C02A-RB10

10 Parça 1/4" 12 Köşe (Yıldız) Lokma Anahtar Takımı - SAE



KOD NO	FİYAT/TL
C02A-RB10	10

10 PC: 3/16, 7/32, 1/4, 9/32, 5/16, 11/32, 3/8, 7/16, 1/2, 9/16 inch

C02-RH13

13 Parça 1/4" 6 Köşe Lokma Anahtar Takımı



KOD NO	FİYAT/TL
C02-RH13	10

13 PC: 4, 4.5, 5, 5.5, 6, 7, 8, 9, 10, 11, 12, 13, 14 mm

C02A-S Serisi

1/4" Spline Lokma Anahtarlar - SAE

6.3
1/4"

KOD NO	inch	mm	FİYAT/TL
C02A-S0316	3/16	25	12•
C02A-S0732	7/32	25	12•
C02A-S0104	1/4	25	12•
C02A-S0932	9/32	25	12•
C02A-S0516	5/16	25	12•
C02A-S1132	11/32	25	12•
C02A-S0308	3/8	25	12•
C02A-S0716	7/16	25	12•

C04-H Serisi

1/4" 6 Köşe Derin Lokma Anahtarlar

6.3
1/4"

KOD NO	mm	mm	FİYAT/TL
C04-H040	4	50	12•
C04-H045	4.5	50	12•
C04-H050	5	50	12•
C04-H055	5.5	50	12•
C04-H060	6	50	12•
C04-H070	7	50	12•
C04-H080	8	50	12•
C04-H090	9	50	12•
C04-H100	10	50	12•
C04-H110	11	50	12•
C04-H120	12	50	12•
C04-H130	13	50	12•
C04-H140	14	50	12•



Teşhir kartlı sipariş için = Ürün Kodu + X



Kart Bedeli

6

3 Lokma Anahtarlar ve Aksesuarları

C04-RH08

8 Parça 1/4" 6 Köşe Derin Lokma Anahtar Takımı



KOD NO		FİYAT/TL
C04-RH08	10	

8 PC: 6, 7, 8, 9, 10, 11, 12, 13 mm

C04-B Serisi

1/4" 12 Köşe (Yıldız) Derin Lokma Anahtarlar



6.3
1/4"

KOD NO		mm	mm		FİYAT/TL
C04-B08	8	50	12	•	
C04-B10	10	50	12	•	
C04-B13	13	50	12	•	



Teşhir kartlı sipariş için = Ürün Kodu + X

6

C04A-B Serisi

1/4" 12 Köşe (Yıldız) Derin Lokma Anahtarlar - SAE



6.3
1/4"

KOD NO		mm	mm		FİYAT/TL
C04A-B0316	3/16	50	6	•	
C04A-B0732	7/32	50	6	•	
C04A-B0104	1/4	50	6	•	
C04A-B0932	9/32	50	6	•	
C04A-B0516	5/16	50	6	•	
C04A-B1132	11/32	50	6	•	
C04A-B0308	3/8	50	6	•	
C04A-B0716	7/16	50	6	•	
C04A-B0102	1/2	50	6	•	
C04A-B0916	9/16	50	6	•	

C04A-RB10

10 Parça 1/4" 12 Köşe (Yıldız) Derin Lokma Anahtar Takımı - SAE



KOD NO		FİYAT/TL
C04A-RB10	10	

10 PC: 3/16, 7/32, 1/4, 9/32, 5/16, 11/32, 3/8, 7/16, 1/2, 9/16 inch

C02UA Serisi

1/4" 12 Köşe (Yıldız) Mafsallı Lokma Anahtarlar - SAE



6.3
1/4"

KOD NO		mm	mm		FİYAT/TL
C02UA-0732	7/32	36	6		
C02UA-0104	1/4	36	6		
C02UA-0932	9/32	38	6		
C02UA-0516	5/16	38	6		
C02UA-1132	11/32	38	6		
C02UA-0308	3/8	40	6		
C02UA-0716	7/16	40	6		
C02UA-0102	1/2	40	6		
C02UA-0916	9/16	42	6		

C02UA-RB09

9 Parça 1/4" 12 Köşe (Yıldız) Mafsallı Lokma Anahtar Takımı - SAE



KOD NO		FİYAT/TL
C02UA-RB09	6	

9 PC: 7/32, 1/4, 9/32, 5/16, 11/32, 3/8, 7/16, 1/2, 9/16 inch

C06 Serisi

1/4" Dış TORX Lokma Anahtarlar



6.3
1/4"

KOD NO		mm		FİYAT/TL
C06-04	E04	25	12	•
C06-05	E05	25	12	•
C06-06	E06	25	12	•
C06-07	E07	25	12	•
C06-08	E08	25	12	•
C06-10	E10	25	12	•



Teşhir kartlı sipariş için = Ürün Kodu + X

6

C06-R06

6 Parça 1/4" Dış TORX Lokma Anahtar Takımı



KOD NO		FİYAT/TL
C06-R06	10	

6 PC: E04, E05, E06, E07, E08, E10

C08S-S Serisi

1/4" Düz Uçlu Lokmalar



6.3
1/4"

KOD NO		mm	mm		FİYAT/TL
C08S-S40	4.0	37	12	•	
C08S-S55	5.5	37	12	•	
C08S-S65	6.5	37	12	•	



Teşhir kartlı sipariş için = Ürün Kodu + X

6

Kart Bedeli

C08S-PH Serisi

1/4" Yıldız Uçlu Lokmalar



6.3
1/4"

KOD NO		mm		FİYAT/TL
C08S-PH1	PH1	37	12	•
C08S-PH2	PH2	37	12	•
C08S-PH3	PH3	37	12	•



Teşhir kartlı sipariş için = Ürün Kodu + X

6

Kart Bedeli

C08S-PZ Serisi

1/4" Pozidriv Uçlu Lokmalar



6.3
1/4"

KOD NO		mm		FİYAT/TL
C08S-PZ1	PZ1	37	12	•
C08S-PZ2	PZ2	37	12	•
C08S-PZ3	PZ3	37	12	•



Teşhir kartlı sipariş için = Ürün Kodu + X

6

Kart Bedeli

C08S-T Serisi

1/4" TORX Uçlu Lokmalar

6.3
1/4"

KOD NO		mm		FİYAT/TL
C08S-T06	T06	37	12•	
C08S-T07	T07	37	12•	
C08S-T08	T08	37	12•	
C08S-T09	T09	37	12•	
C08S-T10	T10	37	12•	
C08S-T15	T15	37	12•	
C08S-T20	T20	37	12•	
C08S-T25	T25	37	12•	
C08S-T27	T27	37	12•	
C08S-T30	T30	37	12•	
C08S-T40	T40	37	12•	



Teşhir kartlı sipariş için = Ürün Kodu + X



Kart Bedeli

6

C08S-RTX7

7 Parça 1/4" TORX Uçlu Lokma Takımı



KOD NO		FİYAT/TL
C08S-RTX7	10	

7 PC: T10, T15, T20, T25, T27, T30, T40

C08S-TR Serisi

1/4" Delikli TORX Uçlu Lokmalar

6.3
1/4"

KOD NO		mm		FİYAT/TL
C08S-TR08	T08	37	12•	
C08S-TR09	T09	37	12•	
C08S-TR10	T10	37	12•	
C08S-TR15	T15	37	12•	
C08S-TR20	T20	37	12•	
C08S-TR25	T25	37	12•	
C08S-TR27	T27	37	12•	
C08S-TR30	T30	37	12•	
C08S-TR40	T40	37	12•	



Teşhir kartlı sipariş için = Ürün Kodu + X



Kart Bedeli

6

C08S-RTR7

7 Parça 1/4" Delikli TORX Uçlu Lokma Takımı



KOD NO		FİYAT/TL
C08S-RTR7	10	

7 PC: T10, T15, T20, T25, T27, T30, T40

C08S-IPR Serisi

1/4" 5 Köşe Delikli TORX Uçlu Lokmalar

6.3
1/4"

KOD NO		mm		FİYAT/TL
C08S-IPR10	IPR10	37	12•	
C08S-IPR15	IPR15	37	12•	
C08S-IPR20	IPR20	37	12•	
C08S-IPR25	IPR25	37	12•	
C08S-IPR27	IPR27	37	12•	
C08S-IPR30	IPR30	37	12•	
C08S-IPR40	IPR40	37	12•	



Teşhir kartlı sipariş için = Ürün Kodu + X



Kart Bedeli

6

C08S-RTP7

7 Parça 1/4" 5 Köşe Delikli TORX Uçlu Lokma Takımı



KOD NO		FİYAT/TL
C08S-RTP7	10	

7 PC: IPR10, IPR15, IPR20, IPR25, IPR27, IPR30, IPR40

C08S-H Serisi

1/4" Allen Uçlu Lokmalar

6.3
1/4"

KOD NO	mm	mm		FİYAT/TL
C08S-H25	2.5	37	12•	
C08S-H30	3.0	37	12•	
C08S-H40	4.0	37	12•	
C08S-H50	5.0	37	12•	
C08S-H60	6.0	37	12•	
C08S-H70	7.0	37	12•	
C08S-H80	8.0	37	12•	



Teşhir kartlı sipariş için = Ürün Kodu + X



Kart Bedeli

6

C08S-RHX7

7 Parça 1/4" Allen Uçlu Lokma Takımı



KOD NO		FİYAT/TL
C08S-RHX7	10	

7 PC: 2,5, 3, 4, 5, 6, 7, 8 mm

C08AS-H Serisi

1/4" Allen Uçlu Lokmalar - SAE

6.3
1/4"

KOD NO	inch	mm		FİYAT/TL
C08AS-H0116	1/16	55	6•	
C08AS-H0564	5/64	55	6•	
C08AS-H0332	3/32	55	6•	
C08AS-H0764	7/64	55	6•	
C08AS-H0108	1/8	55	6•	
C08AS-H0964	9/64	55	6•	
C08AS-H0532	5/32	55	6•	
C08AS-H0316	3/16	55	6•	
C08AS-H0732	7/32	55	6•	
C08AS-H0104	1/4	55	6•	
C08AS-H0516	5/16	55	6•	

C08AS-RHX11

11 Parça 1/4" Allen Uçlu Lokma Takımı - SAE



KOD NO		FİYAT/TL
C08AS-RHX11	10	

11 PC: 1/16, 5/64, 3/32, 7/64, 1/8, 9/64, 5/32, 3/16, 7/32, 1/4, 5/16 inch

3 Lokma Anahtarlar ve Aksesuarları

C01-11

1/4" Düğmeli Cırcır Kolu (Kompakt Kafa)

6.3
1/4"



KOD NO	mm	mm	FİYAT/TL
C01-11	19	140	6

C01-14N

1/4" Düğmeli Cırcır Kolu (Ağlı Gövde)

6.3
1/4"



KOD NO	mm	mm	FİYAT/TL
C01-14N	28	150	6

C01-HLOK

1/4" Hi-Lok Cırcır Kolu (Mafsallı)

6.3
1/4"



KOD NO	mm	mm	FİYAT/TL
C01-HLOK	23	160	6

C01-12

1/4" Düğmeli Cırcır Kolu

6.3
1/4"



KOD NO	mm	mm	FİYAT/TL
C01-12	22.5	140	6

C01-T90

1/4" Kapalı Tip Cırcır Kolu (Kısa Tip - Metal Saplı)

6.3
1/4"



KOD NO	mm	mm	FİYAT/TL
C01-T90	23	112	6

Kart Bedeli

Teşhir kartlı sipariş için = Ürün Kodu + X 6

HLD-0564

Hi-Lok Allen Anahtar Tornavidası

inch
1/4"



KOD NO	mm	mm	FİYAT/TL
HLD-0564	5/64	100	6

C01-15

1/4" Mini Cırcır Kolu

6.3
1/4"



KOD NO	mm	mm	FİYAT/TL
C01-15	22.5	95	6

C01-T90L

1/4" Kapalı Tip Cırcır Kolu (Uzun Tip - Metal Saplı)

6.3
1/4"



KOD NO	mm	mm	FİYAT/TL
C01-T90L	23	145	6

Kart Bedeli

Teşhir kartlı sipariş için = Ürün Kodu + X 6



C01-R Serisi

1/4" Cırcır Kolu Yedek Parça Takımları

KOD NO		FİYAT/TL
C01-11R (C01-11 için)	1	



KOD NO		FİYAT/TL
C01-12R (C01-12 / 12MR / 15 için)	1	



KOD NO		FİYAT/TL
C01-14NR (C01-14N için)	1	



KOD NO		FİYAT/TL
C01-T90R (C01-T90 için)	1	



KOD NO		FİYAT/TL
C01-T90LR (C01-T90L için)	1	

**C01-35MR**

1/4" Mafsallı Kol (Metal Sap)

6.3
1/4"

KOD NO	mm	FİYAT/TL
C01-35MR	145	6

C01-20 Serisi

1/4" Lokma Tornavidaları

yeni
tasarım6.3
1/4"

KOD NO	mm	FİYAT/TL
C01-20S	40	6
C01-20	70	6
		Kart Bedeli
		6



Teşhir kartlı sipariş için = Ürün Kodu + X

C01-20F

1/4" Lokma Tornavidası (Esnek Süngülü)

yeni
tasarım6.3
1/4"

KOD NO	mm	mm	FİYAT/TL
C01-20F	150	240	6
			Kart Bedeli
			6



Teşhir kartlı sipariş için = Ürün Kodu + X

C01-40

1/4" T Kol

6.3
1/4"

KOD NO	mm	FİYAT/TL
C01-40	115	12
		Kart Bedeli
		6



Teşhir kartlı sipariş için = Ürün Kodu + X

C01-50MR

1/4" Fırdöndü Kol (Metal Avuç Saplı)

6.3
1/4"

KOD NO	mm	FİYAT/TL
C01-50MR	420	3

C01-60

1/4" T Saplı Oynar Başlı Lokma Kolu

6.3
1/4"

KOD NO	mm	FİYAT/TL
C01-60	495	6

3 Lokma Anahtarlar ve Aksesuarları

C01-70 Serisi 1/4" Uzatma Kolları



6.3
1/4"

KOD NO	mm	FİYAT/TL
C01-71	50 - 2"	12
C01-72	75 - 3"	12
C01-73	100 - 4"	12
C01-75	150 - 6"	12
C01-77	250 - 10"	12
C01-78	350 - 14"	12

Kart Bedeli
Teşhir kartlı sipariş için = Ürün Kodu + X 6

C01-73W 1/4" Uzatma Kolu (Bombe Başlı)



6.3
1/4"

KOD NO	mm	FİYAT/TL
C01-73W	100 - 4"	6

Kart Bedeli
Teşhir kartlı sipariş için = Ürün Kodu + X 6

C01-75F 1/4" Bükülebilir Uzatma Kolu



6.3
1/4"

KOD NO	mm	FİYAT/TL
C01-75F	150 - 6"	12

Kart Bedeli
Teşhir kartlı sipariş için = Ürün Kodu + X 6

C012 Serisi Lokma Rayları (Boş)



KOD NO	mm	FİYAT/TL
C012-16	160	6•
C012-19	190	6•
C012-26	265	6•
C012-34	340	6•

C01-80 1/4" Üniversal Mafsal



6.3
1/4"

KOD NO	mm	FİYAT/TL
C01-80	38	12•

Kart Bedeli
Teşhir kartlı sipariş için = Ürün Kodu + X 6

C01-92 1/4" Lokma Adaptörü



10
3/8"

6.3
1/4"

KOD NO	mm	FİYAT/TL
C01-92	1/4 < 3/8	26

Kart Bedeli
Teşhir kartlı sipariş için = Ürün Kodu + X 6

BT/8001 1/4" Bits Tutucu Lokma



6.3
1/4"

KOD NO	mm	FİYAT/TL
BT/8001	1/4 - 1/4	25

C01-C 1/4" Lokma Klipsi - 10'lü Paket



6.3
1/4"

KOD NO	FİYAT/TL
C01-C	1 pk.

C00-15RH4 15 Parça 1/4" 6 Köşe Lokma Takımı (Pratik Çanta)



6.3
1/4"

KOD NO	FİYAT/TL
C00-15RH4	1

C02-H 4, 5, 5.5, 6, 7, 8, 9, 10, 11, 12, 13 mm
C01-14N
C01-40
C01-80
C01-73 100 mm

C00-25RH4 25 Parça 1/4" 6 Köşe Lokma Takımı (Pratik Çanta)



6.3
1/4"

KOD NO	FİYAT/TL
C00-25RH4	1

C02-H 4, 5, 5.5, 6, 7, 8, 9, 10, 11, 12, 13 mm
C01-14N
C01-73 100 mm
C01-40
C01-80
C085-H 3, 4, 5, 6 mm
C085-T T20, T25, T30
C085-S 5.5 mm
C085-PH PH1, PH2

C00-27PH5 27 Parça 1/4" 6 Köşe Lokma Takımı (Kompakt Kutu)



6.3
1/4"

KOD NO	FİYAT/TL
C00-27PH5	1

C02-H 4, 4.5, 5, 5.5, 6, 7, 8, 9, 10, 11, 12, 13 mm
C01-15
C01-73 100 mm
CB/250 PH1, PH2
CB/1800 3, 4, 5, 6 mm
CB/800 T10, T15, T20, T25, T30, T40
BT/8001 1/4" - 1/4"

3 Lokma Anahtarlar ve Aksesuarları

C12-H Serisi

3/8" 6 Köşe Lokma Anahtarlar



10
3/8"

KOD NO	Ømm	mm	FİYAT/TL
C12-H06	6	28	12•
C12-H07	7	28	12•
C12-H08	8	28	12•
C12-H09	9	28	12•
C12-H10	10	28	12•
C12-H11	11	28	12•
C12-H12	12	28	12•
C12-H13	13	28	12•
C12-H14	14	28	12•
C12-H15	15	28	12•
C12-H16	16	30	12•
C12-H17	17	30	12•
C12-H18	18	30	12•
C12-H19	19	30	12•
C12-H20	20	32	12•
C12-H21	21	32	12•
C12-H22	22	32	12•

Teşhir kartlı sipariş için = Ürün Kodu + X 6 Kart Bedeli

C12-RH10

10 Parça 3/8" 6 Köşe Lokma Anahtar Takımı



KOD NO	FİYAT/TL
C12-RH10	10

10 PC: 10, 11, 12, 13, 14, 15, 16, 17, 18, 19 mm

C12A-B Serisi

3/8" 12 Köşe (Yıldız) Lokma Anahtarlar - SAE



10
3/8"

KOD NO	Ø"	mm	FİYAT/TL
C12A-B0104	1/4	28	6•
C12A-B0516	5/16	28	6•
C12A-B0308	3/8	28	6•
C12A-B0716	7/16	28	6•
C12A-B0102	1/2	28	6•
C12A-B0916	9/16	28	6•
C12A-B0508	5/8	28	6•
C12A-B1116	11/16	30	6•
C12A-B0304	3/4	30	6•
C12A-B1316	13/16	30	6•
C12A-B0708	7/8	30	6•
C12A-B1516	15/16	32	6•
C12A-B1000	1	32	6•

C12A-RB13

13 Parça 3/8" 12 Köşe (Yıldız) Lokma Anahtar Tk. - SAE



KOD NO	FİYAT/TL
C12A-RB13	10

13 PC: 1/4, 5/16, 3/8, 7/16, 1/2, 9/16, 5/8, 11/16, 3/4, 13/16, 7/8, 15/16, 1 inch

C12A-S Serisi

3/8" Spline Lokma Anahtarlar - SAE



10
3/8"

KOD NO	Ø"	mm	FİYAT/TL
C12A-S0308	3/8	28	12•
C12A-S0716	7/16	28	12•
C12A-S1532	15/32	28	12•
C12A-S0102	1/2	28	12•
C12A-S0916	9/16	28	12•
C12A-S1932	19/32	28	12•
C12A-S0508	5/8	28	12•

C14-H Serisi

3/8" 6 Köşe Derin Lokma Anahtarlar



10
3/8"

KOD NO	Ømm	mm	FİYAT/TL
C14-H08	8	63	12•
C14-H09	9	63	12•
C14-H10	10	63	12•
C14-H11	11	63	12•
C14-H12	12	63	12•
C14-H13	13	63	12•
C14-H14	14	63	12•
C14-H15	15	63	12•
C14-H16	16	63	12•
C14-H17	17	63	12•
C14-H18	18	63	12•
C14-H19	19	63	12•

Teşhir kartlı sipariş için = Ürün Kodu + X 6 Kart Bedeli

C14-RH10

10 Parça 3/8" 6 Köşe Derin Lokma Anahtar Takımı



KOD NO	FİYAT/TL
C14-RH10	10

10 PC: 10, 11, 12, 13, 14, 15, 16, 17, 18, 19 mm

C14-RB10

10 Parça 3/8" 12 Köşe (Yıldız) Derin Lokma Anahtar Takımı



KOD NO	FİYAT/TL
C14-RB10	10

10 PC: 10, 11, 12, 13, 14, 15, 16, 17, 18, 19 mm

C14A-B Serisi

3/8" 12 Köşe (Yıldız) Derin Lokma Anahtarlar - SAE



10
3/8"

KOD NO	Ø"	mm	FİYAT/TL
C14A-B0104	1/4	63	6•
C14A-B0516	5/16	63	6•
C14A-B0308	3/8	63	6•
C14A-B0716	7/16	63	6•
C14A-B0102	1/2	63	6•
C14A-B0916	9/16	63	6•
C14A-B0508	5/8	63	6•
C14A-B1116	11/16	63	6•
C14A-B0304	3/4	63	6•
C14A-B1316	13/16	63	6•
C14A-B0708	7/8	63	6•
C14A-B1516	15/16	63	6•
C14A-B1000	1	63	6•

C14A-RB13

13 Parça 3/8" 12 Köşe (Yıldız) Derin Lokma Anahtar Takımı - SAE



KOD NO	FİYAT/TL
C14A-RB13	10

13 PC: 1/4, 5/16, 3/8, 7/16, 1/2, 9/16, 5/8, 11/16, 3/4, 13/16, 7/8, 15/16, 1 inch

C12U-RB10

10 Parça 3/8" 12 Köşe (Yıldız) Mafsallı Lokma Anahtar Tk.



KOD NO		FİYAT/TL
C12U-RB10	6	
10 PC: 10, 11, 12, 13, 14, 15, 16, 17, 18, 19 mm		

C16 Serisi

3/8" Dış TORX Lokma Anahtarlar

10
3/8"

KOD NO		mm		FİYAT/TL
C16-04	E04	28	12	•
C16-05	E05	28	12	•
C16-06	E06	28	12	•
C16-07	E07	28	12	•
C16-08	E08	28	12	•
C16-10	E10	28	12	•
C16-11	E11	28	12	•
C16-12	E12	28	12	•
C16-14	E14	28	12	•
C16-16	E16	28	12	•
C16-18	E18	28	12	•
C16-20	E20	28	12	•

Teşhir kartlı sipariş için = Ürün Kodu + X Kart Bedeli 6

C16-R10

10 Parça 1/4" + 3/8" Dış TORX Lokma Anahtar Takımı



KOD NO		FİYAT/TL
C16-R10	10	
5 PC: C06 E4, E5, E6, E7, E8 - 1/4 inch		
5 PC: C16 E10, E12, E14, E16, E18 - 3/8 inch		

C16D Serisi

3/8" Dış TORX Derin Lokma Anahtarlar

10
3/8"

KOD NO		mm		FİYAT/TL
C16D-08	E08	63	6	•
C16D-10	E10	63	6	•
C16D-12	E12	63	6	•
C16D-14	E14	63	6	•

Teşhir kartlı sipariş için = Ürün Kodu + X Kart Bedeli 6

C18S-T Serisi

3/8" TORX Uçlu Lokmalar

10
3/8"

KOD NO		mm		FİYAT/TL
C18S-T10	T10	48	12	•
C18S-T15	T15	48	12	•
C18S-T20	T20	48	12	•
C18S-T25	T25	48	12	•
C18S-T27	T27	48	12	•
C18S-T30	T30	48	12	•
C18S-T40	T40	48	12	•
C18S-T45	T45	48	12	•
C18S-T50	T50	48	12	•
C18S-T55	T55	48	12	•

Teşhir kartlı sipariş için = Ürün Kodu + X Kart Bedeli 6

C18S-RT09

9 Parça 3/8" TORX Uçlu Lokma Seti



KOD NO		FİYAT/TL
C18S-RT09	10	
9 PC: T10, T15, T20, T25, T27, T30, T40, T45, T50		

C15-RH10

10 Parça 3/8" Karga Ayağı Anahtar Takımı



KOD NO		FİYAT/TL
C15-RH10	6	
10 PC: 10, 11, 12, 13, 14, 15, 16, 17, 18, 19 mm		

C18S-H Serisi

3/8" Allen Uçlu Lokmalar

10
3/8"

KOD NO		mm		FİYAT/TL
C18S-H03	3	48	12	•
C18S-H04	4	48	12	•
C18S-H05	5	48	12	•
C18S-H06	6	48	12	•
C18S-H07	7	48	12	•
C18S-H08	8	48	12	•
C18S-H09	9	48	12	•
C18S-H10	10	48	12	•

Teşhir kartlı sipariş için = Ürün Kodu + X Kart Bedeli 6

C18S-RH08

8 Parça 3/8" Allen Uçlu Lokma Seti



KOD NO		FİYAT/TL
C18S-RH08	10	
8 PC: 3, 4, 5, 6, 7, 8, 9, 10 mm		

3 Lokma Anahtarlar ve Aksesuarları

C11-11

3/8" Düğmeli Cırcır Kolu (Kompakt Kafa)

10
3/8"



KOD NO	mm	mm	FİYAT/TL
C11-11	27	200	6

C11-12

3/8" Düğmeli Cırcır Kolu

10
3/8"



KOD NO	mm	mm	FİYAT/TL
C11-12	30.5	200	6

C11-14N

3/8" Düğmeli Cırcır Kolu (Açılı Gövde)

10
3/8"



KOD NO	mm	mm	FİYAT/TL
C11-14N	33	210	6

C11-T90

3/8" Kapalı Tip Cırcır Kolu (Metal Saplı)

10
3/8"



KOD NO	mm	mm	FİYAT/TL
C11-T90	33	200	6



Teşhir kartlı sipariş için = Ürün Kodu + X

6

C11-36MR

3/8" Mafsallı Kol (Metal Saplı)

10
3/8"



KOD NO	mm	FİYAT/TL
C11-36MR	250	6

C11-R Serisi

3/8" Cırcır Kolu Yedek Parça Takımları

KOD NO	FİYAT/TL
C11-11R (C11-11 için)	1



C11-12R (C11-12 / C11-12MR için)	1
----------------------------------	---



C11-14NR (C11-14N için)	1
-------------------------	---



C11-T90R (C11-T90 için)	1
-------------------------	---



C11-20 Serisi

3/8" Lokma Tornavidaları

10
3/8"



KOD NO	mm	FİYAT/TL
C11-20S	35	6
C11-20	60	6



Teşhir kartlı sipariş için = Ürün Kodu + X

6

C11-40

3/8" T Kol



10
3/8"

KOD NO	mm	FİYAT/TL
C11-40	200	12



Teşhir kartlı sipariş için = Ürün Kodu + X

6

C11-50MR

3/8" Fırdöndü Kol (Metal Avuç Saplı)



10
3/8"

KOD NO	mm	FİYAT/TL
C11-50MR	420	3

C11-60

3/8" T Saplı Oynar Başlı Lokma Kolu



10
3/8"

KOD NO	mm	FİYAT/TL
C11-60	500	3

C11-70 Serisi

3/8" Uzatma Kolları



10
3/8"

KOD NO	mm		FİYAT/TL
C11-72	75 - 3"	12	
C11-75	150 - 6"	12	
C11-77	250 - 10"	12	
C11-78	300 - 12"	6	
C11-79	450 - 18"	6	
		Kart Bedeli	
		Teşhir kartlı sipariş için = Ürün Kodu + X	6

C11-70W Serisi

3/8" Uzatma Kolları (Bombe Başlı)



10
3/8"

KOD NO	mm		FİYAT/TL
C11-72W	75 - 3"	6	
C11-75W	150 - 6"	6	
		Kart Bedeli	
		Teşhir kartlı sipariş için = Ürün Kodu + X	6

C11-76F

3/8" Bükülebilir Uzatma Kolu



10
3/8"

KOD NO	mm		FİYAT/TL
C11-76F	200 - 8"	6	
		Kart Bedeli	
		Teşhir kartlı sipariş için = Ürün Kodu + X	6

C11-60S

3/8" T Saplı Lokma Kolu



10
3/8"

Quick Release

KOD NO	mm		FİYAT/TL
C11-60S	230	6	

C11-80

3/8" Ünsel Mafsal



10
3/8"

KOD NO	mm		FİYAT/TL
C11-80	53	12 •	
		Kart Bedeli	
		Teşhir kartlı sipariş için = Ürün Kodu + X	6

C11-91

3/8" Lokma Adaptörü - D:3/8" E:1/4"

6.3
1/4"



10
3/8"

KOD NO	"	mm		FİYAT/TL
C11-91	3/8 > 1/4	28	12 •	
			Kart Bedeli	
			Teşhir kartlı sipariş için = Ürün Kodu + X	6

C11-92S

3/8" Lokma Adaptörü - D:3/8" E:1/2"

12.5
1/2"



10
3/8"

KOD NO	"	mm		FİYAT/TL
C11-92S	3/8 < 1/2	43	12 •	
			Kart Bedeli	
			Teşhir kartlı sipariş için = Ürün Kodu + X	6

C11-92

3/8" Lokma Adaptörü (Kol Yuvalı) - D:3/8" E:1/2"

12.5
1/2"



10
3/8"

KOD NO	"	mm		FİYAT/TL
C11-92	3/8 < 1/2	43	12 •	
			Kart Bedeli	
			Teşhir kartlı sipariş için = Ürün Kodu + X	6

BT/8000 3/8" Serisi

3/8" Bits Tutucu Lokmalar



10
3/8"

KOD NO	mm		FİYAT/TL
BT/8003	1/4"	28	6 •
BT/8004	5/16"	28	6 •
BT/8005	10 mm	28	6 •

C012 Serisi

Lokma Rayları (Boş)



KOD NO	mm		FİYAT/TL
C012-16	160	6 •	
C012-19	190	6 •	
C012-26	265	6 •	
C012-34	340	6 •	

C11-C

3/8" Lokma Klipsi - 10'lu Paket



10
3/8"

KOD NO		FİYAT/TL
C11-C	1 pk.	

C10-15PG1

15 Parça Multi-Fix Lokma Takımı

Multi-Fix

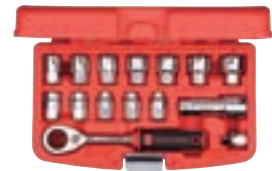

19
mm



KOD NO		FİYAT/TL
C10-15PG1	1	
C11-11G		
C11G-H 10, 11, 12, 13, 14, 15, 16, 17, 18, 19, 21, 22 mm		
C11-72G 80 mm		
C11G-RA02 3/8"		

C22A-B Serisi

1/2" 12 Köşe (Yıldız) Lokma Anahtarlar - SAE

12.5
1/2"

KOD NO	Ø"	mm	FİYAT/TL
C22A-B03	3/8	38	6•
C22A-B04	7/16	38	6•
C22A-B05	1/2	38	6•
C22A-B06	9/16	38	6•
C22A-B06/2	19/32	38	6•
C22A-B07	5/8	38	6•
C22A-B08	11/16	38	6•
C22A-B09	3/4	38	6•
C22A-B10	13/16	38	6•
C22A-B11	7/8	38	6•
C22A-B12	15/16	38	6•
C22A-B13	1	40	6•
C22A-B14	1-1/16	42	6•
C22A-B15	1-1/8	44	6•
C22A-B16	1-3/16	44	6•
C22A-B17	1-1/4	44	6•



Teşhir kartlı sipariş için = Ürün Kodu + X



Kart Bedeli

C22-RH11

11 Parça 1/2" 6 Köşe Lokma Takımı



KOD NO	FİYAT/TL
C22-RH11	10

11 PC: 10, 11, 12, 13, 14, 15, 16, 17, 19, 21, 22 mm

C22-RB11

11 Parça 1/2" 12 Köşe (Yıldız) Lokma Anahtar Takımı



KOD NO	FİYAT/TL
C22-RB11	10

11 PC: 10, 11, 12, 13, 14, 15, 16, 17, 19, 21, 22 mm

C22A-RB11

11 Parça 1/2" 12 Köşe (Yıldız) Lokma Anahtar Takımı - SAE



KOD NO	FİYAT/TL
C22A-RB11	10

11 PC: 3/8, 7/16, 1/2, 9/16, 5/8, 11/16, 3/4, 13/16, 7/8, 15/16, 1 inch

C24-H Serisi

1/2" 6 Köşe Derin Lokma Anahtarlar

12.5
1/2"

KOD NO	Ømm	mm	FİYAT/TL
C24-H08	8	77	12•
C24-H10	10	77	12•
C24-H11	11	77	12•
C24-H12	12	77	12•
C24-H13	13	77	12•
C24-H14	14	77	12•
C24-H15	15	77	12•
C24-H16	16	77	12•
C24-H17	17	77	12•
C24-H18	18	77	12•
C24-H19	19	77	12•
C24-H20	20	77	12•
C24-H21	21	77	12•
C24-H22	22	77	12•
C24-H24	24	77	6•
C24-H27	27	77	6•
C24-H30	30	77	6•
C24-H32	32	77	6•



Teşhir kartlı sipariş için = Ürün Kodu + X



Kart Bedeli

C24-RH09

9 Parça 1/2" 6 Köşe Derin Lokma Anahtar Takımı



KOD NO	FİYAT/TL
C24-RH09	5

9 PC: 10, 11, 12, 13, 14, 17, 19, 21, 22 mm

C26 Serisi

1/2" Dış TORX Lokma Anahtarlar

12.5
1/2"

KOD NO	Ømm	mm	FİYAT/TL
C26-10	E10	38	12•
C26-11	E11	38	12•
C26-12	E12	38	12•
C26-14	E14	38	12•
C26-16	E16	38	12•
C26-18	E18	38	12•
C26-20	E20	38	12•
C26-22	E22	38	12•
C26-24	E24	38	12•



Teşhir kartlı sipariş için = Ürün Kodu + X



Kart Bedeli

C24-B Serisi

1/2" 12 Köşe (Yıldız) Derin Lokma Anahtarlar

12.5
1/2"

KOD NO	Ømm	mm	FİYAT/TL
C24-B08	8	77	12•
C24-B10	10	77	12•
C24-B11	11	77	12•
C24-B12	12	77	12•
C24-B13	13	77	12•
C24-B14	14	77	12•
C24-B15	15	77	12•
C24-B16	16	77	12•
C24-B17	17	77	12•
C24-B18	18	77	12•
C24-B19	19	77	12•
C24-B20	20	77	12•
C24-B21	21	77	12•
C24-B22	22	77	12•
C24-B24	24	77	6•
C24-B27	27	77	6•
C24-B30	30	77	6•
C24-B32	32	77	6•



Teşhir kartlı sipariş için = Ürün Kodu + X



Kart Bedeli

C24-RB09

9 Parça 1/2" 12 Köşe (Yıldız) Derin Lokma Anahtar Takımı



KOD NO	FİYAT/TL
C24-RB09	5

9 PC: 10, 11, 12, 13, 14, 17, 19, 21, 22 mm

C26-R08

8 Parça 1/2" Dış TORX Lokma Anahtar Takımı



KOD NO	FİYAT/TL
C26-R08	10

8 PC: E10, E12, E14, E16, E18, E20, E22, E24

3 Lokma Anahtarlar ve Aksesuarları

C28S-T Serisi

1/2" TORX Uçlu Lokmalar - Kısa Tip



12.5
1/2"

KOD NO	Uç	mm	FİYAT/TL
C28S-T20	T20	55	12•
C28S-T25	T25	55	12•
C28S-T27	T27	55	12•
C28S-T30	T30	55	12•
C28S-T35	T35	55	12•
C28S-T40	T40	55	12•
C28S-T45	T45	55	12•
C28S-T50	T50	55	12•
C28S-T55	T55	55	6•
C28S-T60	T60	55	6•
C28S-T70	T70	55	6•

Teşhir kartlı sipariş için = Ürün Kodu + X 6 Kart Bedeli

C28S-TR Serisi

1/2" Delikli TORX Uçlu Lokmalar - Kısa Tip



12.5
1/2"

KOD NO	Uç	mm	FİYAT/TL
C28S-TR30	T30	55	6•
C28S-TR40	T40	55	6•
C28S-TR45	T45	55	6•
C28S-TR50	T50	55	6•
C28S-TR55	T55	55	6•

Teşhir kartlı sipariş için = Ürün Kodu + X 6 Kart Bedeli

C28S-H Serisi

1/2" Allen Uçlu Lokmalar - Kısa Tip



12.5
1/2"

KOD NO	mm	mm	FİYAT/TL
C28S-H04	4	55	12•
C28S-H05	5	55	12•
C28S-H06	6	55	12•
C28S-H07	7	55	12•
C28S-H08	8	55	12•
C28S-H09	9	55	12•
C28S-H10	10	55	12•
C28S-H12	12	55	12•
C28S-H14	14	55	6•
C28S-H17	17	60	6•
C28S-H19	19	60	6•

Teşhir kartlı sipariş için = Ürün Kodu + X 6 Kart Bedeli

C28S-RT9

9 Parça 1/2" TORX Uçlu Lokma Takımı - Kısa Tip



KOD NO	FİYAT/TL
C28S-RT9	10

9 PC: T20, T25, T27, T30, T40, T45, T50, T55, T60

C28S-TR30XL

1/2" Delikli TORX Uçlu Lokma - Ekstra Uzun Tip



12.5
1/2"

KOD NO	Uç	mm	FİYAT/TL
C28S-TR30XL	T30	140	6•

Teşhir kartlı sipariş için = Ürün Kodu + X 6 Kart Bedeli

C28S-RH9

9 Parça 1/2" Allen Uçlu Lokma Takımı - Kısa Tip



KOD NO	FİYAT/TL
C28S-RH9	10

9 PC: 4, 5, 6, 7, 8, 10, 12, 14, 17 mm

C28S-TL Serisi

1/2" TORX Uçlu Lokmalar - Uzun Tip



12.5
1/2"

KOD NO	Uç	mm	FİYAT/TL
C28S-T20L	T20	100	12•
C28S-T25L	T25	100	12•
C28S-T27L	T27	100	12•
C28S-T30L	T30	100	12•
C28S-T35L	T35	100	12•
C28S-T40L	T40	100	12•
C28S-T45L	T45	100	12•
C28S-T50L	T50	100	12•
C28S-T55L	T55	100	6•
C28S-T60L	T60	100	6•
C28S-T70L	T70	100	6•

Teşhir kartlı sipariş için = Ürün Kodu + X 6 Kart Bedeli

C28S-HL Serisi

1/2" Allen Uçlu Lokmalar - Uzun Tip



12.5
1/2"

CODE NO	mm	mm	FİYAT/TL
C28S-H05L	5	100	12•
C28S-H06L	6	100	12•
C28S-H06XL	6	140	6•
C28S-H06XL2	6	220	6•
C28S-H07L	7	100	12•
C28S-H08L	8	100	12•
C28S-H09L	9	100	12•
C28S-H10L	10	100	12•
C28S-H10XL	10	140	6•
C28S-H11L	11	100	12•
C28S-H12L	12	100	12•
C28S-H12XL	12	140	6•
C28S-H13L	13	100	6•
C28S-H14L	14	100	6•

Teşhir kartlı sipariş için = Ürün Kodu + X 6 Kart Bedeli



C28AS-H Serisi

1/2" Allen Uçlu Lokmalar - Kısa Tip/SAE

yeniinch
12.512.5
1/2"

KOD NO	mm	mm		FİYAT/TL
C28AS-H0532	5/32	55	6•	
C28AS-H0316	3/16	55	6•	
C28AS-H0732	7/32	55	6•	
C28AS-H0104	1/4	55	6•	
C28AS-H0516	5/16	55	6•	
C28AS-H0308	3/8	55	6•	
C28AS-H0102	1/2	55	6•	
C28AS-H0916	9/16	55	6•	
C28AS-H0508	5/8	55	6•	

C28AS-RH9

9 Parça 1/2" Allen Uçlu Lokma Takımı - Kısa Tip/SAE

yeni

KOD NO		FİYAT/TL
C28AS-RH9	10	
9 PC: 5/32, 3/16, 7/32, 1/4, 5/16, 3/8, 1/2, 9/16, 5/8 inch		

C28S-HBXL Serisi

1/2" Topbaşı Allen Uçlu Lokmalar - Ekstra Uzun Tip

inch
12.512.5
1/2"

KOD NO	mm	mm		FİYAT/TL
C28S-HB05XL	5	140	6•	
C28S-HB06XL	6	140	6•	
C28S-HB07XL	7	140	6•	
C28S-HB08XL	8	140	6•	
C28S-HB10XL	10	140	6•	



Teşhir kartlı sipariş için = Ürün Kodu + X



Kart Bedeli

6

C28S-X Serisi

1/2" XZN Uçlu Lokmalar - Kısa Tip

inch
12.512.5
1/2"

KOD NO		mm		FİYAT/TL
C28S-X05	M05	55	6•	
C28S-X06	M06	55	6•	
C28S-X08	M08	55	6•	
C28S-X10	M10	55	6•	
C28S-X12	M12	55	6•	
C28S-X14	M14	55	6•	
C28S-X16	M16	55	6•	



Teşhir kartlı sipariş için = Ürün Kodu + X



Kart Bedeli

6

C28S-RX6

6 Parça 1/2" XZN Uçlu Lokma Takımı - Kısa Tip



KOD NO		FİYAT/TL
C28S-RX6	10	
6 PC: M05, M06, M08, M10, M12, M14		

C28S-X.L Serisi

1/2" XZN Uçlu Lokmalar - Uzun Tip

inch
12.512.5
1/2"

KOD NO		mm		FİYAT/TL
C28S-X06L	M06	100	6•	
C28S-X08L	M08	100	6•	
C28S-X10L	M10	100	6•	
C28S-X10XL	M10	140	6•	
C28S-X12L	M12	100	6•	
C28S-X12XL	M12	140	6•	
C28S-X14L	M14	100	6•	



Teşhir kartlı sipariş için = Ürün Kodu + X



Kart Bedeli

6

C28S-RX5L

5 Parça 1/2" XZN Uçlu Lokma Tk. - Uzun Tip



KOD NO		FİYAT/TL
C28S-RX5L	10	
5 PC: M06, M08, M10, M12, M14		

C28S-RL Serisi

1/2" RIBE Uçlu Lokmalar - Uzun Tip

inch
12.512.5
1/2"

KOD NO		mm		FİYAT/TL
C28S-R05L	M05	99	6•	
C28S-R06L	M06	99	6•	
C28S-R08L	M08	99	6•	
C28S-R10L	M10	99	6•	
C28S-R12L	M12	99	6•	
C28S-R14L	M14	99	6•	



Teşhir kartlı sipariş için = Ürün Kodu + X



Kart Bedeli

6

C28S-RR6L

6 Parça 1/2" RIBE Uçlu Lokma Tk. - Uzun Tip



KOD NO		FİYAT/TL
C28S-RR6L	10	
6 PC: M05, M06, M08, M10, M12, M14		

3 Lokma Anahtarlar ve Aksesuarları

C28-SS40

40 Parça H10 TORX-Allen-XZN Lokmalı Bits Uç Tk.



KOD NO	FIYAT/TL
C28-SS40	1



BT/8005 3/8" - 10 mm
BT/8008 1/2" - 10 mm



CB/1000G T20, T25, T30, T40, T45, T50, T55

CB/1100G T20, T25, T30, T40, T45, T50, T55



CB/2000G 4, 5, 6, 7, 8, 10, 12 mm



CB/2100G 4, 5, 6, 7, 8, 10, 12 mm



CB/3000G M5, M6, M8, M10, M12



CB/3100G M5, M6, M8, M10, M12

C28S-17PTH

17 Parça 1/2" TORX ve Allen Uçlu Lokma Takımı

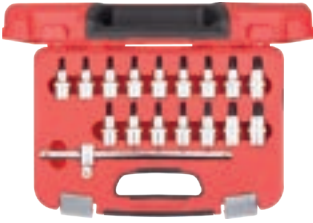

KOD NO	FIYAT/TL
C28S-17PTH	1



C28S-T T20, T25, T27, T30, T40, T45, T50, T55, T60



C28S-H 5, 6, 7, 8, 10, 12, 14 mm



C21-40

C20-18PTX

18 Parça 1/2" TORX Lokma Takımı



KOD NO	FIYAT/TL
C20-18PTX	1



C26 E10, E11, E12, E14, E16, E18, E20, E22, E24



C28S-T T20, T25, T27, T30, T40, T45, T50, T55, T60

C21-11

1/2" Düğmeli Cırcır Kolu (Kompakt Kafa)



KOD NO	mm	mm	FIYAT/TL
C21-11	32	255	6

C21-12

1/2" Düğmeli Cırcır Kolu



KOD NO	mm	mm	FIYAT/TL
C21-12	41.5	260	6

C21-14N

1/2" Düğmeli Cırcır Kolu (Açılı Gövde)



KOD NO	mm	mm	FIYAT/TL
C21-14N	42	250	6

C21-T90

1/2" Kapalı Tip Cırcır Kolu (Metal Saplı)



KOD NO	mm	mm	FIYAT/TL
C21-T90	41	255	6

Teşhir kartlı sipariş için = Ürün Kodu + X Kart Bedeli

C21-R Serisi

1/2" Cırcır Kolu Yedek Parça Takımları

KOD NO	FIYAT/TL
C21-11R (C21-11 için)	1



C21-12R (C21-12 için)	1
-----------------------	---



C21-14NR (C21-14N için)	1
-------------------------	---



C21-T90R (C21-T90 için)	1
-------------------------	---



C21-20

1/2" L Kol



KOD NO	mm	FIYAT/TL
C21-20	250	12

C21-30MR Serisi

1/2" Mafsallı Kollar (Metal Saplı)

Yeni



KOD NO	mm	FIYAT/TL
C21-38MR	375	6
C21-39MR	475	6

C21-40 Serisi

1/2" T Kollar

12.5
1/2"

KOD NO	mm		FİYAT/TL
C21-40	250	12	
C21-40L	300	12	
			Kart Bedeli
			Teşhir kartlı sipariş için = Ürün Kodu + X 6

C21-50

1/2" Fırdöndü Kol

12.5
1/2"

KOD NO	mm		FİYAT/TL
C21-50	420	3	

C21-60

1/2" T Saplı Oynar Başlı Lokma Kolu

12.5
1/2"

KOD NO	mm		FİYAT/TL
C21-60	500	3	

C21-60S

1/2" T Saplı Lokma Kolu

12.5
1/2"

KOD NO	mm		FİYAT/TL
C21-60S	230	6	

C21-70 Serisi

1/2" Uzatma Kolları

12.5
1/2"

KOD NO	mm		FİYAT/TL
C21-72	75 - 3"	12	
C21-74	125 - 5"	12	
C21-77	250 - 10"	12	
			Kart Bedeli
			Teşhir kartlı sipariş için = Ürün Kodu + X 6

C21-70W Serisi

1/2" Uzatma Kolları (Bombe Başlı)

12.5
1/2"

KOD NO	mm		FİYAT/TL
C21-71W	50 - 2"	6	
C21-74W	125 - 5"	6	
C21-77W	250 - 10"	6	
C21-79W	500 - 20"	6	
			Kart Bedeli
			Teşhir kartlı sipariş için = Ürün Kodu + X 6

C21-80

1/2" Üniversal Mafsall

12.5
1/2"

KOD NO	mm		FİYAT/TL
C21-80	73	12	
			Kart Bedeli
			Teşhir kartlı sipariş için = Ürün Kodu + X 6

C012 Serisi

Lokma Rayları (Boş)



KOD NO	mm		FİYAT/TL
C012-16	160	6	
C012-19	190	6	
C012-26	265	6	
C012-34	340	6	

C21-91S

1/2" Lokma Adaptörü - D:1/2" E:3/8"

10
3/8"12.5
1/2"

KOD NO	"	"	mm		FİYAT/TL
C21-91S	1/2	> 3/8	38	12	
					Kart Bedeli
					Teşhir kartlı sipariş için = Ürün Kodu + X 6

C21-91

1/2" Lokma Adaptörü (Kol Yuvalı) - D:1/2" E:3/8"

10
3/8"12.5
1/2"

KOD NO	"	"	mm		FİYAT/TL
C21-91	1/2	> 3/8	38	12	
					Kart Bedeli
					Teşhir kartlı sipariş için = Ürün Kodu + X 6

C21-92

1/2" Lokma Adaptörü - D:1/2" E:3/4"

20
3/4"12.5
1/2"

KOD NO	"	"	mm		FİYAT/TL
C21-92	1/2	< 3/4	50	12	
					Kart Bedeli
					Teşhir kartlı sipariş için = Ürün Kodu + X 6

BT/8000 1/2" Serisi

1/2" Bits Tutucu Lokmalar

10
1/2"12.5
1/2"

KOD NO	"	mm		FİYAT/TL
BT/8007	5/16"	28	6	
BT/8008	10 mm	38	6	

C21-C

1/2" Lokma Klipsi - 10'lu Paket

12.5
1/2"12.5
1/2"

KOD NO		FİYAT/TL
C21-C	1 pk.	

3 Lokma Anahtarlar ve Aksesuarları

C21-90KIT15

15 Parça Lokma Adaptör Seti

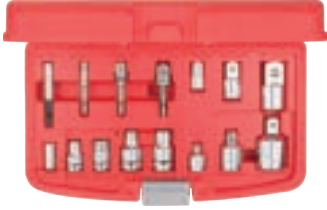

KOD NO	FİYAT/TL
C21-90KIT15	1
BT/8001 1/4" - 1/4"	
BT/8004 3/8" - 5/16"	
BT/8005 3/8" - 10 mm	
BT/8007 1/2" - 5/16"	
BT/8008 1/2" - 10 mm	
C01-92 D:1/4" < E:3/8"	
C11-91 D:3/8" > E:1/4"	
C11-92S D:3/8" < E:1/2"	
C21-91S D:1/2" > E:3/8"	
C21-92 D:1/2" < E:3/4"	
C31-91 D:3/4" > E:1/2"	
BT/7015 (1/4" - 1/4") x 50 mm	
BT/7020 (3/8" - 1/4") x 50 mm	
BT/7030 (1/2" - 1/4") x 50 mm	
BT/02 (1/4" x 60 mm)	

C21-90KIT6

6 Parça Lokma Adaptör Seti



KOD NO	FİYAT/TL
C21-90KIT6	1
C01-92 D:1/4" < E:3/8"	
C21-91S D:1/2" > E:3/8"	
C11-92S D:3/8" < E:1/2"	
C11-91 D:3/8" > E:1/4"	
C21-92 D:1/2" < E:3/4"	
C31-91 D:3/4" > E:1/2"	

C20-18PH2

18 Parça 1/2" 6 Köşe Lokma Takımı



12.5
1/2"

KOD NO	FİYAT/TL
C20-18PH2	1
C22-H 8, 10, 11, 12, 13, 14, 15, 16, 17, 19, 21, 22, 24 mm	
C11-92 D:3/8" < E:1/2"	
C21-12	
C21-70 125 mm, 250 mm	
C21-80	

C20-23PH4

23 Parça 1/2" 6 Köşe Lokma Takımı

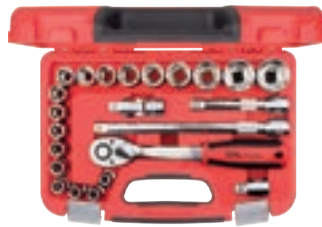

12.5
1/2"

KOD NO	FİYAT/TL
C20-23PH4	1
C22-H 8, 9, 10, 11, 12, 13, 14, 15, 16, 17, 18, 19, 21, 22, 24, 27, 30, 32 mm	
C11-92 D:3/8" < E:1/2"	
C21-14N	
C21-80	

C20-25PH2

25 Parça 1/2" 6 Köşe Lokma Takımı



12.5
1/2"

KOD NO	FİYAT/TL
C20-25PH2	1
C22-H 8, 9, 10, 11, 12, 13, 14, 15, 16, 17, 18, 19, 21, 22, 24, 27, 30, 32 mm	
C11-92 D:3/8" < E:1/2"	
C21-12	
C21-80	
C21-70 125 mm, 250 mm	

C20-25PB2

25 Parça 1/2" 12 Köşe (Yıldız) Lokma Takımı



12.5
1/2"

KOD NO	FİYAT/TL
C20-25PB2	1
C22-B 8, 9, 10, 11, 12, 13, 14, 15, 16, 17, 18, 19, 21, 22, 24, 27, 30, 32 mm	
C11-92 D:3/8" < E:1/2"	
C21-12	
C21-80	
C21-70 125 mm, 250 mm	

C20-56PH2

56 Parça 1/2" 6 Köşe Lokma Takımı

12.5
1/2"

KOD NO		FİYAT/TL
C20-56PH2	1	



C22-H 10, 11, 12, 13, 14, 15, 16, 17, 18, 19, 21, 22, 24, 27, 30, 32 mm



C24-H 10, 12, 13, 14, 15, 16, 17, 19, 22 mm



C27-R 16, 21 mm



C21-12



C21-40

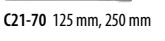

C21-70 125 mm, 250 mm



C21-80



BT/8007 1/2" - 5/16"



CB/516SL 8, 10, 12 mm



CB/516PH PH2, PH3, PH4



CB/516PZ P22, P23, P24



CB/516TX T20, T25, T30, T40, T45, T50, T55



CB/516HX 5, 6, 7, 8, 10, 12, 14

C20-49PH2

49 Parça 1/2" 6 Köşe Lokma ve Anahtar Seti

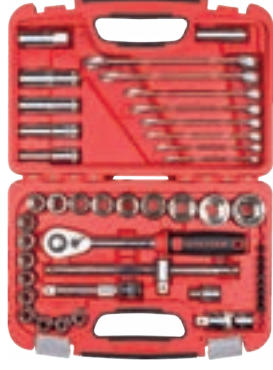
yeni
içerik12.5
1/2"

KOD NO		FİYAT/TL
C20-49PH2	1	

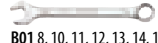

B01 8, 10, 11, 12, 13, 14, 17, 19 mm



C22-H 8, 9, 10, 11, 12, 13, 14, 15, 16, 17, 18, 19, 21, 22, 24, 27, 30, 32 mm



C24-H 10, 13, 17, 19 mm



C27-R 16, 21 mm



C21-12



C21-70 125 mm, 250 mm



C21-80



C11-92 D:3/8" < E:1/2"



BT/8007 1/2" - 5/16"



CB/516SL 10 mm



CB/516PH PH2, PH3, PH4



CB/516TX T30, T40, T45, T50



CB/516HX 5, 6, 8 mm

C20-35PH4

35 Parça 1/4"+1/2" 6 Köşe Lokma Takımı

6.3
1/4"12.5
1/2"

KOD NO		FİYAT/TL
C20-35PH4	1	



C02-H 4, 4.5, 5, 5.5, 6, 7, 8, 9, 10, 11, 12, 13 mm



C01-14N



C01-80



C01-73 100 mm



C21-14N

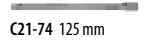

C21-74 125 mm



C21-80



L 1.3, 1.5, 2, 2.5, 3 mm



C01-73 100 mm

C20A-20PBT

20 Parça 1/2" 12 Köşe (Yıldız) Lokma Takımı - SAE

12.5
1/2"

KOD NO		FİYAT/TL
C20A-20PBT	1	



C22-A-B 3/8, 7/16, 1/2, 9/16, 5/8, 11/16, 3/4, 13/16, 7/8, 15/16, 1, 1-1/16, 1-1/8, 1-3/16, 1-1/4 inch



C21-T90



C21-70 125 mm, 250 mm



C11-92 D:3/8" < E:1/2"



C21-80

C20A-34PM2

34 Parça 1/2" Lokma Takımı - Metrik / SAE

yeni

12.5
1/2"

KOD NO		FİYAT/TL
C20A-34PM2	1	



C22-H 8, 10, 11, 12, 13, 14, 15, 16, 17, 18, 19, 20, 21, 22, 24, 27, 30, 32 mm



C22-A-B 3/8, 7/16, 1/2, 9/16, 5/8, 11/16, 3/4, 13/16, 7/8, 15/16, 1 inch



C21-12



C21-40



C21-70 125 mm, 250 mm



C21-80



3 Lokma Anahtarlar ve Aksesuarları

C20-96PH2

96 Parça 1/4"+1/2" Lokma Takımı



6.3
1/4" 12.5
1/2"

KOD NO	FİYAT/TL
C20-96PH2	1
C02-H 4, 4.5, 5, 5.5, 6, 7, 8, 9, 10, 11, 12, 13, 14 mm	C22-H 10, 11, 12, 13, 14, 15, 16, 17, 18, 19, 20, 21, 22, 24, 27, 30, 32 mm
C04-H 6, 7, 8, 9, 10, 11, 12, 13 mm	C24-H 14, 15, 17, 19, 22 mm
C08S-S 4, 5.5, 6.5 mm	C27-R 16, 21 mm
C08S-PH PH1, PH2	C21-12
C08S-PZ PZ1, PZ2	C21-70 125 mm, 250 mm
C08S-T T8, T10, T15, T20, T25, T27, T30	C21-80
C08S-H 3, 4, 5, 6 mm	BT/8007 1/2" - 5/16"
C01-12	CB/516SL 8, 10, 12 mm
C01-20	CB/516PH PH3, PH4
C01-40	CB/516PZ PZ3, PZ4
C01-70 50 mm, 100 mm	CB/516TX T40, T45, T50, T55
C01-75F 150 mm	CB/516HX 7, 8, 10, 12, 14 mm
C01-80	L 1.3, 1.5, 2, 2.5 mm
C11-92 D:1/4" > E:3/8"	

C20-180PH2

180 Parça 1/4"+3/8"+1/2" Lokma Takımı

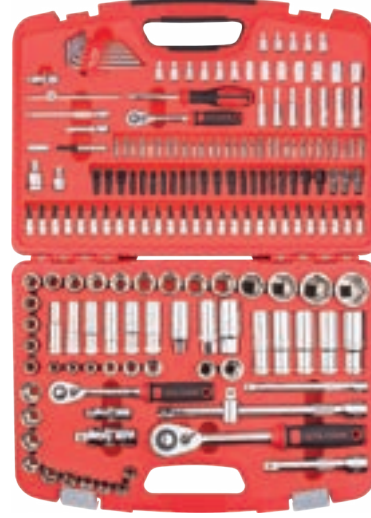

6.3
1/4" 10
3/8" 12.5
1/2"

KOD NO	FİYAT/TL		
C20-180PH2			
C02-H 4, 4.5, 5, 5.5, 6, 7, 8, 9, 10, 11, 12, 13, 14 mm	C01-40	C22-H 10, 11, 12, 13, 14, 15, 16, 17, 18, 19, 20, 21, 22, 24, 27, 30, 32 mm	CB/800 T5, T6, T7, T8, T9, T10, T15, T20, T25, T27, T30, T40
C04-H 4, 5, 6, 7, 8, 9, 10 mm	C01-70 50 mm, 100 mm	C24-H 16, 17, 18, 19, 22 mm	CB/800IPR IPR10, IPR15, IPR20, IPR25, IPR27, IPR30, IPR40
C06 E4, E5, E6, E7, E8	C01-80	C26 E20, E24	CB/850 M5, M6, M8
C08S-S 4, 5.5, 6.5 mm	C12-H 10, 11, 12, 13, 14, 15, 16, 17, 18, 19 mm	C27-R 16, 21 mm	BT/02 (1/4" x 60 mm)
C08S-PH PH1, PH2	C14-H 10, 11, 12, 13, 14, 15 mm	C21-12	BT/8004 3/8" - 5/16" BT/8007 1/2" - 5/16"
C08S-PZ PZ1, PZ2	C16 E10, E11, E12, E14, E16, E18	C21-70 125 mm, 250 mm	CB/516SL 8, 10, 12 mm
C08S-T T8, T9, T10, T15, T20, T25, T27, T30	C17-R18 18 mm	C21-80	CB/516PH PH3, PH4
C08S-H 3, 4, 5, 6 mm	C11-12	LT/7 1.5, 2, 2.5, 3, 4, 5, 6 mm	CB/516PZ PZ3, PZ4
C01-12	C11-75 150 mm	BT/8001 1/4" - 1/4"	CB/516TX T40, T45, T50, T55
C01-20	C11-80	CB/250 PH0, PH1, PH2, PH3	CB/516TR T40, T45, T50
C01-40	C11-92 D:3/8" > E:1/2"	CB/350 PZ0, PZ1, PZ2, PZ3	CB/516HX 7, 8, 10, 12, 14 mm
C01-70 50 mm, 100 mm			CB/516XZ M10, M12, M14
C01-75F 150 mm			
C01-80			
C11-92 D:1/4" > E:3/8"			

C32-H Serisi

3/4" 6 Köşe Lokma Anahtarlar

20
3/4"

KOD NO	mm	mm	FİYAT/TL
C32-H19	19	50	6
C32-H21	21	50	6
C32-H22	22	50	6
C32-H24	24	52	6
C32-H27	27	52	6
C32-H30	30	54	6
C32-H32	32	55	3
C32-H33	33	56	3
C32-H34	34	56	3
C32-H36	36	57	3
C32-H38	38	60	3
C32-H41	41	64	3
C32-H46	46	68	3
C32-H50	50	72	3
C32-H55	55	75	3
C32-H60	60	78	3

C32-B Serisi

3/4" 12 Köşe (Yıldız) Lokma Anahtarlar

20
3/4"

KOD NO	mm	mm	FİYAT/TL
C32-B22	22	50	6
C32-B24	24	50	6
C32-B27	27	52	6
C32-B30	30	54	6
C32-B32	32	56	3
C32-B36	36	58	3
C32-B38	38	60	3
C32-B41	41	64	3
C32-B46	46	68	3
C32-B50	50	73	3

C32A-B Serisi

3/4" 12 Köşe (Yıldız) Lokma Anahtarlar - SAE

20
3/4"

KOD NO	"	mm	FİYAT/TL
C32A-B11	7/8	50	6
C32A-B12	15/16	50	6
C32A-B13	1	51	6
C32A-B14	1-1/16	52	6
C32A-B15	1-1/8	52	6
C32A-B17	1/4	54	3
C32A-B27	1/7/8	70	3

C38S-H Serisi

3/4" Allen Uçlu Lokmalar

20
3/4"

KOD NO	mm	mm	FİYAT/TL
C38S-H14	14	80	6
C38S-H17	17	80	6
C38S-H19	19	80	6
C38S-H22	22	80	6

C31-12-2

3/4" Düğmeli Cırcır Kolu

20
3/4"

KOD NO	mm	mm	FİYAT/TL
C31-12-2	63	505	1

C31-12-2R

Cırcır Kolu Yedek Parça Takımı

KOD NO	FİYAT/TL
C31-12-2R (C31-12-2 için)	1

**C31-40**

3/4" T Kol

20
3/4"

KOD NO	mm	FİYAT/TL
C31-40	500	3

C31-70 Serisi

3/4" Uzatma Kolları

20
3/4"

KOD NO	mm	FİYAT/TL
C31-73	100 - 4"	6
C31-76	200 - 8"	6
C31-78	400 - 16"	6

C31-91

3/4" Lokma Adaptörü - D:3/4" E:1/2"

Garanti
Kassam Dış12.5
1/2"20
3/4"

KOD NO	"	mm	FİYAT/TL
C31-91	3/4 > 1/2	54	6

C31-92

3/4" Lokma Adaptörü - D:3/4" E:1"

25
1"20
3/4"

KOD NO	"	mm	FİYAT/TL
C31-92	3/4 < 1	63	6

3 Lokma Anahtarlar ve Aksesuarları

C30-14MH2

14 Parça 3/4" 6 Köşe Lokma Takımı



KOD NO	FİYAT/TL
C30-14MH2	1



C32-H 22, 24, 27, 30, 32, 36, 38, 41, 46, 50 mm



C31-40 500 mm



C31-12-2 505 mm



C31-70 100, 200 mm

C30-14MB2

14 Parça 3/4" 12 Köşe (Yıldız) Lokma Anahtar Takımı



KOD NO	FİYAT/TL
C30-14MB2	1



C32-B 22, 24, 27, 30, 32, 36, 38, 41, 46, 50 mm



C31-40 500 mm



C31-12-2 505 mm



C31-70 100, 200 mm

C42-B Serisi

1" 12 Köşe (Yıldız) Lokma Anahtarlar



25
1"

KOD NO	mm	mm	FİYAT/TL
C42-B32	32	63	3
C42-B36	36	65	3
C42-B41	41	70	3
C42-B46	46	70	3
C42-B50	50	75	3
C42-B55	55	80	1
C42-B60	60	82	1
C42-B65	65	87	1
C42-B70	70	94	1
C42-B75	75	100	1
C42-B80	80	103	1

C41-12

1" Cırcır Kolu



25
1"

KOD NO	mm	mm	FİYAT/TL
C41-12	70	675	1

C41-12/H

1" Cırcır Kol (Sadece Kafa)



25
1"

KOD NO	mm	mm	FİYAT/TL
C41-12/H	70	200	1

C41-12R

Cırcır Kolu Yedek Parça Takımı (C41-12 için)



KOD NO	FİYAT/TL
C41-12R	1

C41-12/T

Kol (C41-12/H ve C41-40R için)



KOD NO	mm	FİYAT/TL
C41-12/T	550	1

C41-40

1" T Kol



25
1"

KOD NO	mm	FİYAT/TL
C41-40	550	1

C41-40R

1" T-Kol Karesi (C41-40 için)



25
1"

KOD NO	FİYAT/TL
C41-40R	1

C41-70 Serisi

1" Uzatma Kolları



25
1"

KOD NO	mm	FİYAT/TL
C41-76	200 - 8"	1
C41-78	400 - 16"	1

C41-91

1" Lokma Adaptörü - D:1" E:3/4"



Garanti!
Economic Day

20
3/4"

25
1"

KOD NO	mm	FİYAT/TL
C41-91	1 > 3/4	64 3

C40-15MB2

eski kod C40-15MH2

15 Parça 1" 12 Köşe (Yıldız) Lokma Takımı



KOD NO	FİYAT/TL
C40-15MB2	1



C42-B 36, 41, 46, 50, 55, 60, 65, 70, 75, 80 mm



C41-12/T 545 mm



C41-40R



C41-12/H 200 mm



C41-70 200 mm, 400 mm

C52-H Serisi

1/4" 6 Köşe Havalı Lokma Anahtarlar

6.3
1/4"

KOD NO	mm	mm	FİYAT/TL
C52-H06	6	25	6•
C52-H07	7	25	6•
C52-H13	13	25	6•
			Kart Bedeli
			6

C52R-H Serisi

3/8" 6 Köşe Havalı Lokma Anahtarlar

10
3/8"

KOD NO	mm	mm	FİYAT/TL
C52R-H08	8	30	6•
C52R-H10	10	30	6•
C52R-H11	11	30	6•
C52R-H12	12	30	6•
C52R-H13	13	30	6•
C52R-H14	14	30	6•
C52R-H15	15	30	6•
C52R-H16	16	30	6•
C52R-H17	17	30	6•
C52R-H18	18	30	6•
C52R-H19	19	30	6•
			Kart Bedeli
			6

C52R-RH10

10 Parça 3/8" 6 Köşe Havalı Lokma Anahtar Takımı



KOD NO	FİYAT/TL
C52R-RH10	6
10 PC: 10, 11, 12, 13, 14, 15, 16, 17, 18, 19 mm	

C51R-72

3/8" Havalı Uzatma Kolu

10
3/8"

KOD NO	mm	FİYAT/TL
C51R-72	75 - 3"	6
		Kart Bedeli
		6

C51R-80

3/8" Havalı Ünsel Mafsal

10
3/8"

KOD NO	mm	FİYAT/TL
C51R-80	50	6
		Kart Bedeli
		6

C51R-91

3/8" Havalı Lokma Adaptörü - D:3/8" E:1/4"

6.3
1/4"10
3/8"

KOD NO	"	mm	FİYAT/TL
C51R-91	3/8 > 1/4	32	6•
			Kart Bedeli
			6

C51R-92

3/8" Havalı Lokma Adaptörü - D:3/8" E:1/2"

12.5
1/2"10
3/8"

KOD NO	"	mm	FİYAT/TL
C51R-92	3/8 < 1/2	36	6•
			Kart Bedeli
			6

C62-H Serisi

1/2" 6 Köşe Havalı Lokma Anahtarlar

12.5
1/2"

KOD NO	mm	mm	FİYAT/TL
C62-H10	10	38	6•
C62-H11	11	38	6•
C62-H12	12	38	6•
C62-H13	13	38	6•
C62-H14	14	38	6•
C62-H15	15	38	6•
C62-H16	16	38	6•
C62-H17	17	38	6•
C62-H18	18	38	6•
C62-H19	19	38	6•
C62-H20	20	38	6•
C62-H21	21	38	6•
C62-H22	22	38	6•
C62-H23	23	38	6•
C62-H24	24	38	6•
C62-H27	27	42	6•
C62-H30	30	42	6•
C62-H32	32	44	6•
C62-H36	36	48	6•
			Kart Bedeli
			6

C62-RH09

9 Parça 1/2" 6 Köşe Havalı Lokma Anahtar Takımı



KOD NO	FİYAT/TL
C62-RH09	6
9 PC: 10, 11, 12, 13, 14, 17, 19, 21, 22 mm	

3 Lokma Anahtarlar ve Aksesuarları

C64-H Serisi

1/2" 6 Köşe Derin Havali Lokma Anahtarlar



12.5
1/2"

KOD NO	Ømm	mm	mm	FİYAT/TL
C64-H10	10	78	6•	
C64-H11	11	78	6•	
C64-H12	12	78	6•	
C64-H13	13	78	6•	
C64-H14	14	78	6•	
C64-H15	15	78	6•	
C64-H16	16	78	6•	
C64-H17	17	78	6•	
C64-H18	18	78	6•	
C64-H19	19	78	6•	
C64-H20	20	78	6•	
C64-H21	21	78	6•	
C64-H22	22	78	6•	
C64-H23	23	78	6•	
C64-H24	24	78	6•	
C64-H27	27	78	6•	
C64-H30	30	78	6•	
C64-H32	32	78	6•	

Kart Bedeli
Teşhir kartlı sipariş için = Ürün Kodu + X 6

C64-RH09

9 Parça 1/2" 6 Köşe Derin Havali Lokma Anahtar Tk.



KOD NO	FİYAT/TL
C64-RH09	6

9 PC: 10, 11, 12, 13, 14, 17, 19, 21, 22 mm

C62-B Serisi

1/2" 12 Köşe (Yıldız) Havali Lokma Anahtarlar



12.5
1/2"

KOD NO	Ømm	mm	mm	FİYAT/TL
C62-B24	24	38	6	
C62-B32	32	44	6	
C62-B34	34	42	6	
C62-B36	36	48	6	

Kart Bedeli
Teşhir kartlı sipariş için = Ürün Kodu + X 6

C66-E Serisi

1/2" Dış TORX Havali Lokma Anahtarlar



12.5
1/2"

KOD NO	mm	FİYAT/TL
C66-E10	E10 38	6
C66-E12	E12 38	6
C66-E14	E14 38	6
C66-E16	E16 38	6
C66-E18	E18 38	6
C66-E20	E20 38	6
C66-E22	E22 38	6
C66-E24	E24 38	6

Kart Bedeli
Teşhir kartlı sipariş için = Ürün Kodu + X 6

C66-R08

8 Parça 1/2" Dış TORX Havali Lokma Anahtar Takımı



KOD NO	FİYAT/TL
C66-R08	6

8 PC: E10, E12, E14, E16, E18, E20, E22, E24

C68-T Serisi

1/2" TORX Uçlu Havali Lokmalar



12.5
1/2"

KOD NO	mm	FİYAT/TL
C68-T30	T30 78	6•
C68-T40	T40 78	6•
C68-T45	T45 78	6•
C68-T50	T50 78	6•
C68-T55	T55 78	6•
C68-T60	T60 78	6•
C68-T70	T70 78	6•
C68-T80	T80 78	6•

Kart Bedeli
Teşhir kartlı sipariş için = Ürün Kodu + X 6

C68-RT07

7 Parça 1/2" TORX Uçlu Havali Lokma Takımı



KOD NO	FİYAT/TL
C68-RT07	1

7 PC: T30, T40, T45, T50, T55, T60, T70

C68-H Serisi

1/2" Allen Uçlu Havali Lokmalar



12.5
1/2"

KOD NO	Ømm	mm	FİYAT/TL
C68-H05	5	78	6•
C68-H06	6	78	6•
C68-H07	7	78	6•
C68-H08	8	78	6•
C68-H10	10	78	6•
C68-H12	12	78	6•
C68-H14	14	78	6•
C68-H17	17	78	6•
C68-H19	19	78	6•

Kart Bedeli
Teşhir kartlı sipariş için = Ürün Kodu + X 6

C68-RH07

7 Parça 1/2" Allen Uçlu Havali Lokma Takımı



KOD NO	FİYAT/TL
C68-RH07	1

7 PC: 5, 6, 8, 10, 12, 14, 17 mm

C68-X Serisi

1/2" XZN Uçlu Havalı Lokmalar

12.5
1/2"

KOD NO	mm	mm	FİYAT/TL
C68-X06	M06	78	6
C68-X08	M08	78	6
C68-X10	M10	78	6
C68-X12	M12	78	6
C68-X14	M14	78	6
C68-X16	M16	78	6
C68-X18	M18	78	6

Kart Bedeli
Teşhir kartlı sipariş için = Ürün Kodu + X 6

C68-RX07

7 Parça 1/2" XZN Uçlu Havalı Lokma Takımı



KOD NO	FİYAT/TL
C68-RX07	1

7 PC: M6, M8, M10, M12, M14, M16, M18

C61-70 Serisi

1/2" Havalı Uzatma Kolları

12.5
1/2"

KOD NO	mm	FİYAT/TL
C61-72	75 - 3"	6
C61-74	125 - 5"	6

Kart Bedeli
Teşhir kartlı sipariş için = Ürün Kodu + X 6

C61-80

1/2" Ünsel Mafsal

12.5
1/2"

KOD NO	mm	FİYAT/TL
C61-80	63	6

Kart Bedeli
Teşhir kartlı sipariş için = Ürün Kodu + X 6

C61-91

1/2" Havalı Lokma Adaptörü - D:1/2" E:3/8"

10
3/8"12.5
1/2"

KOD NO	mm	mm	FİYAT/TL
C61-91	1/2 > 3/8	38	6

Kart Bedeli
Teşhir kartlı sipariş için = Ürün Kodu + X 6

C61-92

1/2" Havalı Lokma Adaptörü - D:1/2" E:3/4"

20
3/4"12.5
1/2"

KOD NO	mm	mm	FİYAT/TL
C61-92	1/2 < 3/4	48	6

Kart Bedeli
Teşhir kartlı sipariş için = Ürün Kodu + X 6

BT/8000QR Serisi

1/2" Kilitli Bits Tutucu Havalı Lokmalar

12.5
1/2"

KOD NO	mm	mm	FİYAT/TL
BT/8007QR	5/16"	54	6
BT/8008QR	10 mm	54	6

C61-90KIT7

7 Parça Havalı Lokma Adaptör Seti



KOD NO	FİYAT/TL
C61-90KIT7	1

C51R-91 D:3/8" > E:1/4"	C71-91 D:3/4" > E:1/2"
C51R-92 D:3/8" < E:1/2"	C71-92 D:3/4" < E:1"
C61-91 D:1/2" > E:3/8"	C81-91 D:1" > E:3/4"
C61-92 D:1/2" < E:3/4"	

C72-H Serisi

3/4" 6 Köşe Havalı Lokma Anahtarlar

20
3/4"

KOD NO	mm	mm	FİYAT/TL
C72-H17	17	51	3
C72-H19	19	51	3
C72-H21	21	51	3
C72-H22	22	51	3
C72-H24	24	51	3
C72-H27	27	54	3
C72-H30	30	54	3
C72-H32	32	57	3
C72-H33	33	57	3
C72-H34	34	57	3
C72-H36	36	57	3
C72-H38	38	57	3
C72-H41	41	58	3
C72-H46	46	63	3
C72-H50	50	68	3
C72-H55	55	73	3
C72-H60	60	75	3

C74-H Serisi

3/4" 6 Köşe Derin Havalı Lokma Anahtarlar

20
3/4"

KOD NO	mm	mm	FİYAT/TL
C74-H17	17	90	3
C74-H19	19	90	3
C74-H21	21	90	3
C74-H22	22	90	3
C74-H24	24	90	3
C74-H27	27	90	3
C74-H30	30	90	3
C74-H32	32	90	3
C74-H33	33	90	3
C74-H34	34	90	3
C74-H36	36	90	3
C74-H38	38	90	3
C74-H41	41	90	3
C74-H46	46	90	3
C74-H50	50	90	3

3 Lokma Anahtarlar ve Aksesuarları

C71-70 Serisi

3/4" Havalı Uzatma Kolları



20
3/4"

KOD NO	mm "		FİYAT/TL
C71-75	175 - 7"	3	
C71-77	250 - 10"	3	

C71-80

3/4" Havalı Üniversal Mafsallı



20
3/4"

KOD NO	mm		FİYAT/TL
C71-80	90	3	

C71-91

3/4" Havalı Lokma Adaptörü - D:3/4" E:1/2"



12.5
1/2"



20
3/4"

KOD NO	" "	mm		FİYAT/TL
C71-91	3/4 > 1/2	58	3	

C71-91R

1/2" Yedek Kare (C71-91 için)



12.5
1/2"

KOD NO		FİYAT/TL
C71-91R	6	

C71-92

3/4" Havalı Lokma Adaptörü - D:3/4" E:1"



25
1"



20
3/4"

KOD NO	" "	mm		FİYAT/TL
C71-92	3/4 < 1	63	3	

C82-H Serisi

1" 6 Köşe Havalı Lokma Anahtarlar



25
1"

KOD NO	mm	mm		FİYAT/TL
C82-H24	24	58	1	
C82-H27	27	58	1	
C82-H30	30	60	1	
C82-H32	32	62	1	
C82-H33	33	62	1	
C82-H34	34	62	1	
C82-H36	36	65	1	
C82-H38	38	65	1	
C82-H41	41	68	1	
C82-H46	46	72	1	
C82-H50	50	75	1	
C82-H55	55	83	1	
C82-H60	60	87	1	
C82-H65	65	90	1	
C82-H70	70	93	1	
C82-H75	75	95	1	
C82-H80	80	95	1	

C81-70 Serisi

1" Havalı Uzatma Kolları



25
1"

KOD NO	mm "		FİYAT/TL
C81-75	175 - 7"	1	
C81-77	250 - 10"	1	

C84-H Serisi

1" 6 Köşe Derin Havalı Lokma Anahtarlar



25
1"

KOD NO	mm	mm		FİYAT/TL
C84-H24	24	90	1	
C84-H27	27	90	1	
C84-H30	30	90	1	
C84-H32	32	90	1	
C84-H33	33	90	1	
C84-H34	34	90	1	
C84-H36	36	90	1	
C84-H38	38	95	1	
C84-H41	41	95	1	
C84-H46	46	95	1	
C84-H50	50	100	1	
C84-H55	55	105	1	
C84-H60	60	110	1	
C84-H65	65	115	1	
C84-H70	70	120	1	
C84-H75	75	135	1	
C84-H80	80	135	1	

C81-91

1" Havalı Lokma Adaptörü - D:1" E:3/4"



20
3/4"



25
1"

KOD NO	" "	mm		FİYAT/TL
C81-91	1 > 3/4	70	1	



4 Tork Anahtarları

75 | 76

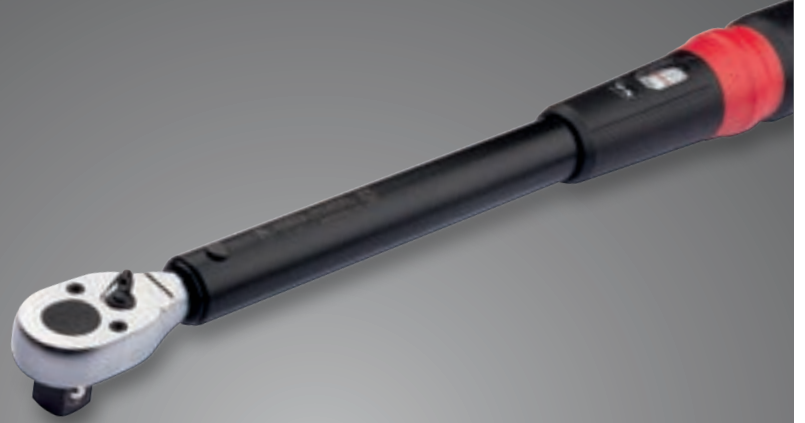

D02F2 Serisi

Exacto Tork Anahtarları (Pencere Göstergeli)



±4 %

KOD NO	N-m	"	mm	FİYAT/TL
D02F2-0125	5 - 25	1/4	275	1
D02F2-1105	10 - 50	3/8	418	1
D02F2-1110	20 - 100	3/8	418	1
D02F2-2110	20 - 100	1/2	418	1
D02F2-2120	40 - 200	1/2	502	1
D02F2-2130	60 - 340	1/2	594	1

D02F2-R Serisi

Tork Anahtarı Yedek Parça Takımları (D02F2 Serisi için)



KOD NO	FİYAT/TL
D02F2-01R D02F2-0125 için	1
D02F2-11R D02F2-1105 ve 1110 için	1
D02F2-21R/1 D02F2-2110 için	1
D02F2-21R/2 D02F2-2120 ve 2130 için	1

D03F2 Serisi

Duo Tork Anahtarları (Skala Göstergeli)

yeni



±4 %

KOD NO	N-m	"	mm	FİYAT/TL
D03F2-0125	5 - 25	1/4	241	1
D03F2-1112	20 - 120	3/8	425	1
D03F2-2122	40 - 220	1/2	503	1
D03F2-2133	60 - 330	1/2	564	1

D03F-31 Serisi

3/4" Duo Tork Anahtarları (Skala Göstergeli)



±4 %

KOD NO	N-m	mm	FİYAT/TL
D03F-3155	110-550	918	1
D03F-3175	150-750	1125	1
D03F-3110	200-1000	1200	1

D03F-31R

Tork Anahtarı Yedek Parça Takımı (D03F-31 Serisi için)



KOD NO	FİYAT/TL
D03F-31R 3/4"	1

D03-21 Serisi

1/2" KLASİK Seri Tork Anahtarları



±4 %

12.5
1/2"

KOD NO	N-m	mm	FİYAT/TL
D03-2114	25 - 135	556	1
D03-2123	50 - 225	585	1
D03-2133	70 - 330	805	1

D03-21R

1/2" Yedek Kare (D03-21 Serisi için)



12.5
1/2"

KOD NO	FİYAT/TL
D03-21R 6•	1

D32-14B Serisi

Tork Tornavidaları

yeni



1/4"

KOD NO	N-m	mm	FİYAT/TL
D32-14B012	0.1 ~ 1.2	180	1
D32-14B060	1 ~ 6	195	1

4 Tork Anahtarları

D02E Serisi

Exacto Soketli Tork Anahtarları

Yeni
tasarım



±4 %

KOD NO	N-m	mm	mm	FİYAT/TL
D02E-0910	20 - 100	9x12	385	1
D02E-1420	40 - 200	14x18	475	1
D02E-1430	60 - 340	14x18	570	1

D02E-RH09 Serisi

Soketli Cırcır Kafaları (9x12)



9x12

KOD NO	"	mm	FİYAT/TL
D02E-RH0938	3/8	56	1
D02E-RH0912	1/2	69	1

D02E-OE09 Serisi

Soketli Açık Ağız Anahtarlar (9x12)



9x12

KOD NO	mm	mm	FİYAT/TL
D02E-OE0908	8	17.5	1
D02E-OE0910	10	17.5	1
D02E-OE0911	11	17.5	1
D02E-OE0912	12	17.5	1
D02E-OE0913	13	17.5	1
D02E-OE0914	14	20	1
D02E-OE0915	15	20	1
D02E-OE0916	16	20	1
D02E-OE0917	17	20	1
D02E-OE0918	18	20	1
D02E-OE0919	19	20	1

D02E-RE09 Serisi

Soketli Yıldız Ağız Anahtarlar (9x12)



9x12

KOD NO	mm	mm	FİYAT/TL
D02E-RE0908	8	17.5	1
D02E-RE0910	10	17.5	1
D02E-RE0911	11	17.5	1
D02E-RE0912	12	17.5	1
D02E-RE0913	13	17.5	1
D02E-RE0914	14	17.5	1
D02E-RE0915	15	17.5	1
D02E-RE0916	16	17.5	1
D02E-RE0917	17	17.5	1
D02E-RE0918	18	17.5	1
D02E-RE0919	19	17.5	1
D02E-RE0922	22	17.5	1

D02E-RH1412

Soketli Cırcır Kafası (14x18)



14x18

KOD NO	"	mm	FİYAT/TL
D02E-RH1412	1/2	78	1

D02E-OE14 Serisi

Soketli Açık Ağız Anahtarlar (14x18)



14x18

KOD NO	mm	mm	FİYAT/TL
D02E-OE1413	13	25	1
D02E-OE1414	14	25	1
D02E-OE1415	15	25	1
D02E-OE1416	16	25	1
D02E-OE1417	17	25	1
D02E-OE1418	18	25	1
D02E-OE1419	19	25	1
D02E-OE1421	21	25	1
D02E-OE1422	22	25	1
D02E-OE1424	24	25	1
D02E-OE1427	27	31.5	1
D02E-OE1430	30	31.5	1
D02E-OE1432	32	31.5	1

D02E-RE14 Serisi

Soketli Yıldız Ağız Anahtarlar (14x18)



14x18

KOD NO	mm	mm	FİYAT/TL
D02E-RE1413	13	25	1
D02E-RE1414	14	25	1
D02E-RE1415	15	25	1
D02E-RE1416	16	25	1
D02E-RE1417	17	25	1
D02E-RE1418	18	25	1
D02E-RE1419	19	25	1
D02E-RE1421	21	25	1
D02E-RE1422	22	25	1
D02E-RE1424	24	25	1
D02E-RE1427	27	31	1
D02E-RE1430	30	31	1
D02E-RE1432	32	31	1

D20-P Serisi

Tork Arttırıcı Takımları



KOD NO	"	"	FİYAT/TL
D20-P2131	1/2 - 3/4	1	
D20-P3141	3/4 - 1	1	

D20HR Serisi

Tork Arttırıcılar (Yüksek Arttırma Oranı)



KOD NO	MAKS. ÇIKIŞ YÜKÜ (N-m)	"	"	FİYAT/TL
D20HR-300	3000	1/2 - 1	1	
D20HR-450	4500	1/2 - 1	1	

Maks. Giriş Yüğü:
D20HR-300: 200 Nm (Oran: 15.5:1)
D20HR-450: 180 Nm (Oran: 26:1)



Maks. Çıkış Yüğü:
D20HR-300: 3000 Nm (Oran: 15.5:1)
D20HR-450: 4500 Nm (Oran: 26:1)

D06-21

1/2" Tork Açı Mastarı



12.5
1/2"

KOD NO	mm	FİYAT/TL
D06-21	52	1

D06-31

3/4" Tork Açı Mastarı

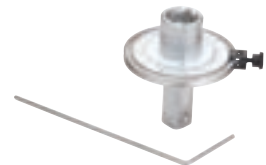

20
3/4"

KOD NO	mm	FİYAT/TL
D06-31	90	1

5 Tornavidalar ve Bits Uçlar

77 | 98



F10 Serisi/ C

C-PLUS Düz Uçlu Tornavidalar (Kabin Tipi)



KOD NO	Ø mm	mm	FIYAT/TL
F10-025-075	2.5	75	12
F10-030-075	3.0	75	12
F10-030-100	3.0	100	12
F10-035-100	3.5	100	12
F10-040-075	4.0	75	12
F10-040-100	4.0	100	12
F10-040-125	4.0	125	12
F10-040-150	4.0	150	12
F10-045-100	4.5	100	12
F10-060-150	6.0	150	12

Topaç Serisi

eski F13 Serisi

F10-040-025	4.0	25	12
F10-055-025	5.5	25	12
F10-065-025	6.5	25	12



F10 Serisi / W

C-PLUS Düz Uçlu Tornavidalar (Atölye Tipi)

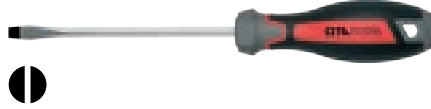

KOD NO	Ø mm	mm	FIYAT/TL
F10-055-100	5.5	100	12
F10-055-125	5.5	125	12
F10-055-150	5.5	150	12
F10-055-200	5.5	200	12
F10-065-100	6.5	100	12
F10-065-125	6.5	125	12
F10-065-150	6.5	150	12
F10-065-200	6.5	200	12
F10-080-150	8.0	150	12
F10-080-175	8.0	175	12
F10-100-200	10.0	200	12
F10-100-250	10.0	250	12
F10-120-250	12.0	250	12

F10-300 Serisi

C-PLUS Düz Uçlu Tornavidalar (Ekstra Uzun Süngü)



KOD NO	Ø mm	mm	FIYAT/TL
F10-040-300	4.0	300	12
F10-055-300	5.5	300	12
F10-065-300	6.5	300	12

F10M Serisi

C-Plus Düz Uçlu Tornavidalar (Vida Tutucu Miknatıslı) **yeni**

KOD NO	Ø mm	mm	FIYAT/TL
F10M-045-100	4.5	100	12
F10M-060-150	6.0	150	12

F14 Serisi

C-PLUS Yıldız Uçlu Tornavidalar



KOD NO	+	mm	FIYAT/TL
F14-000-060	PH0	60	12
F14-000-080	PH0	80	12
F14-001-080	PH1	80	12
F14-001-100	PH1	100	12
F14-001-125	PH1	125	12
F14-001-200	PH1	200	12
F14-002-100	PH2	100	12
F14-002-125	PH2	125	12
F14-002-150	PH2	150	12
F14-002-200	PH2	200	12
F14-003-150	PH3	150	12
F14-004-200	PH4	200	12

Topaç Serisi

eski F16 Serisi

F14-001-025	PH1	25	12
F14-002-025	PH2	25	12



F14-XL Serisi

C-PLUS Yıldız Uçlu Tornavidalar (Ekstra Uzun Süngü)



KOD NO	+	mm	FIYAT/TL
F14-001-300	PH1	300	12
F14-001-500	PH1	500	6
F14-002-300	PH2	300	12
F14-002-500	PH2	500	6



Plastik Askı



Tornavidaları plastik askılı olarak sipariş etmek için standart ürün kodlarının sonuna "X" ekleyiniz. Plastik askı farkı brüt TL'dir.

5 Tornavidalar ve Bits Uçlar

F17 Serisi

C-PLUS Pozitiv Uçlu Tornavidalar



KOD NO	+	mm	mm	FİYAT/TL
F17-000-060	PZ0	60	12	
F17-001-080	PZ1	80	12	
F17-002-100	PZ2	100	12	
F17-003-150	PZ3	150	12	
F17-004-200	PZ4	200	12	

Topaç Serisi



KOD NO	PZ1	25	12
F17-001-025	PZ1	25	12
F17-002-025	PZ2	25	12

F17-300 Serisi

C-PLUS Pozitiv Uçlu Tornavida (Ekstra Uzun Süngü)



KOD NO	+	mm	mm	FİYAT/TL
F17-001-300	PZ1	300	12	
F17-002-300	PZ2	300	12	

F18 Serisi

C-PLUS TORX Uçlu Tornavidalar



KOD NO	T	mm	mm	FİYAT/TL
F18-005-060	T05	60	12	
F18-006-060	T06	60	12	
F18-007-060	T07	60	12	
F18-008-060	T08	60	12	
F18-009-060	T09	60	12	
F18-010-080	T10	80	12	
F18-015-080	T15	80	12	
F18-020-100	T20	100	12	
F18-025-100	T25	100	12	
F18-027-115	T27	115	12	
F18-030-115	T30	115	12	
F18-040-130	T40	130	12	
F18-045-130	T45	130	12	

F18-300 Serisi

C-PLUS TORX Uçlu Tornavidalar (Ekstra Uzun Süngü)



KOD NO	T	mm	mm	FİYAT/TL
F18-015-300	T15	300	12	
F18-020-300	T20	300	12	
F18-025-300	T25	300	12	
F18-030-300	T30	300	12	

F19 Serisi

C-PLUS Delikli TORX Uçlu Tornavidalar



KOD NO	T	mm	mm	FİYAT/TL
F19-010-080	T10	80	12	
F19-015-080	T15	80	12	
F19-020-100	T20	100	12	
F19-025-100	T25	100	12	
F19-027-115	T27	115	12	
F19-030-115	T30	115	12	
F19-040-130	T40	130	12	

F20 Serisi

C-PLUS Lokma Uçlu Tornavidalar



KOD NO	mm	mm	mm	FİYAT/TL
F20-040-125	4	125	12	
F20-050-125	5	125	12	
F20-055-125	5.5	125	12	
F20-060-125	6	125	12	
F20-070-125	7	125	12	
F20-080-125	8	125	12	
F20-090-125	9	125	12	
F20-100-125	10	125	12	
F20-110-125	11	125	12	
F20-120-125	12	125	12	
F20-130-125	13	125	12	
F20-140-125	14	125	12	

F20A Serisi

C-PLUS Lokma Uçlu Tornavidalar - SAE



KOD NO	inch	mm	mm	FİYAT/TL
F20A-0104	1/4	125	12	
F20A-0516	5/16	125	12	
F20A-0308	3/8	125	12	
F20A-0102	1/2	125	12	

F21 Serisi

C-PLUS Lokma Uçlu Tornavidalar (Bükülebilir Süngü)



KOD NO	mm	mm	mm	FİYAT/TL
F21-050-150	5	150	12	
F21-060-150	6	150	12	
F21-070-150	7	150	12	
F21-080-150	8	150	12	
F21-100-150	10	150	12	

F22 Serisi

C-PLUS Allen Uçlu Tornavidalar



KOD NO	mm	mm	mm	FİYAT/TL
F22-020-060	2	60	12	
F22-025-080	2.5	80	12	
F22-030-080	3	80	12	
F22-040-100	4	100	12	
F22-050-100	5	100	12	
F22-060-125	6	125	12	
F22-080-150	8	150	12	
F22-100-150	10	150	12	

F22A Serisi

C-PLUS Allen Uçlu Tornavidalar - SAE



KOD NO	inch	mm	mm	FİYAT/TL
F22A-0116	1/16	60	12	
F22A-0564	5/64	60	12	
F22A-0332	3/32	80	12	
F22A-0764	7/64	80	12	
F22A-0108	1/8	80	12	
F22A-0964	9/64	80	12	
F22A-0532	5/32	100	12	
F22A-0316	3/16	100	12	

F23 Serisi

C-PLUS Topbaşlı Allen Uçlu Tornavidalar



KOD NO	mm	mm	mm	FİYAT/TL
F23-020-100	2	100	12	
F23-025-100	2.5	100	12	
F23-030-100	3	100	12	
F23-040-100	4	100	12	
F23-050-100	5	100	12	
F23-060-125	6	125	12	
F23-080-150	8	150	12	

F23A Serisi

C-PLUS Topbaşlı Allen Uçlu Tornavidalar - SAE



KOD NO	inch	mm	mm	FİYAT/TL
F23A-0532	5/32	100	12	
F23A-0316	3/16	100	12	
F23A-0732	7/32	100	12	
F23A-0104	1/4	125	12	
F23A-0516	5/16	150	12	
F23A-0308	3/8	150	12	

F24 Serisi

C-PLUS Kare Uçlu Tornavidalar



KOD NO	mm	FİYAT/TL
F24-001-080	No.1 80	12
F24-002-100	No.2 100	12
F24-003-150	No.3 150	12

F25 Serisi

C-PLUS TRI-WING Uçlu Tornavidalar



KOD NO	mm	FİYAT/TL
F25-002-080	TW2 80	12
F25-003-080	TW3 80	12
F25-004-100	TW4 100	12
F25-005-100	TW5 100	12

F99-200 Serisi

2 Parça C-PLUS Tornavida Takımları

yeni

KOD NO	FİYAT/TL
F99-201	1
● F10 6.5x100 mm	
⊕ F14 PH2x100 mm	
F99-201P	1
● F10 6.5x100 mm	
⊕ F17 PZ2x100 mm	

F99-200 Serisi / TP

2 Parça C-PLUS Topaç Tornavida Takımları

yeni

KOD NO	FİYAT/TL
F99-202	1
● F10/TP 6.5x25 mm	
⊕ F14/TP PH2x25 mm	
F99-202P	1
● F10/TP 6.5x25 mm	
⊕ F17/TP PZ2x25 mm	

F99-400 Serisi

4 Parça C-PLUS Tornavida Takımları



KOD NO	FİYAT/TL
F99-403	1
⊕ F14 PH0x60, PH1x80, PH2x100, PH3x150 mm	
F99-403P	1
⊕ F17 PZ0x60, PZ1x80, PZ2x100, PZ3x150 mm	

F99-405

4 Parça C-PLUS Tornavida Takımı (Extra Uzun) - TORX



KOD NO	FİYAT/TL
F99-405	1
⊕ F18 T15x300, T20x300, T25x300, T30x300 mm	

F99-500 Serisi

5 Parça C-PLUS Tornavida Takımları



KOD NO	FİYAT/TL
F99-501	1
● F10 2.5x75, 4.0x100, 5.5x125 mm	
⊕ F14 PH1x80, PH2x100 mm	
F99-501P	1
● F10 2.5x75, 4.0x100, 5.5x125 mm	
⊕ F17 PZ1x80, PZ2x100 mm	

F99-502

5 Parça C-PLUS Tornavida Takımı - Düz



KOD NO	FİYAT/TL
F99-502	1
● F10 3.0x75, 4.0x100, 5.5x125, 6.5x150, 8.0x150 mm	

F99-605

6 Parça C-PLUS Tornavida Takımı - TORX



KOD NO	FİYAT/TL
F99-605	1
⊕ F18 T10x80, T15x80, T20x100, T25x100, T30x115, T40x130 mm	

F99-606

6 Parça C-PLUS Tornavida Takımı - Delikli TORX



KOD NO	FİYAT/TL
F99-606	1
⊕ F19 T10x80, T15x80, T20x100, T25x100, T30x115, T40x130 mm	

5 Tornavidalar ve Bits Uçlar

F20-B05

5 Parça C-PLUS Lokma Uçlu Tornavida Takımları



KOD NO		FİYAT/TL
F20-B05	1	
F20	6x125, 7x125, 8x125, 10x125, 13x125 mm	

F99-600 Serisi

6 Parça C-PLUS Tornavida Takımları



KOD NO		FİYAT/TL
F99-601	1	
F10	3.0x75, 4.0x100, 5.5x125, 6.5x150 mm	
F14	PH1x80, PH2x100 mm	
F99-602	1	
F10	3.0x75, 4.0x100, 5.5x125, 6.5x150 mm	
F17	PZ1x80, PZ2x100 mm	

F99-600V Serisi

7 Parça C-PLUS Tornavida Takımları - Kontrol Kalemli



KOD NO		FİYAT/TL
F99-601V	1	
F10	3.0x75, 4.0x100, 5.5x125, 6.5x150 mm	
F14	PH1x80, PH2x100 mm	
6105CP	Kontrol Kalemli - Kısa	
F99-602V	1	
F10	3.0x75, 4.0x100, 5.5x125, 6.5x150 mm	
F17	PZ1x80, PZ2x100 mm	
6105CP	Kontrol Kalemli - Kısa	

F99-700 Serisi

7 Parça C-PLUS Tornavida Takımları



KOD NO		FİYAT/TL
F99-701	1	
F10	3.0x75, 4.0x100, 5.5x125, 6.5x150 mm	
F14	PH0x60, PH1x80, PH2x100 mm	
F99-702	1	
F10	3.0x75, 4.0x100, 5.5x125, 6.5x150 mm	
F17	PZ0x60, PZ1x80, PZ2x100 mm	



F99-901

9 Parça C-PLUS Tornavida Takımı (Deri Çantalı)



KOD NO		FİYAT/TL
F99-901	1	
F10	3.0x75, 4.0x100, 5.5x125, 6.5x150 mm	
F14	PH1x80, PH2x100 mm	
F17	PZ1x80, PZ2x100 mm	
6105CP	Kontrol Kalemli - Kısa	

F99-P41

41 Parça C-PLUS Tornavida Takımı

yeni

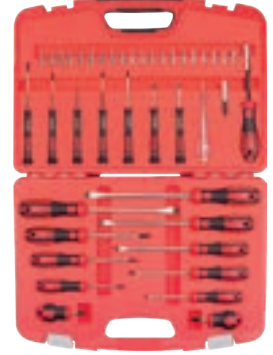

KOD NO		FİYAT/TL
F99-P41	1	
F10	3.0x75, 4.0x100, 5.5x125, 6.5x150, 8.0x150 mm	
F10/TP	6.5x25 mm	
F14	PH0x60, PH1x80, PH2x100, PH3x150 mm	
F14/TP	PH2x25 mm	
6105CP	Kontrol Kalemli (Kısa)	
H01	1.5x40, 2.0x60, 2.5x80 mm	
H02	PH00x60, PH0x60 mm	
H04	T6x40, T8x40 mm	
F26/BT	C-PLUS Bits Tornavidası	
BT/02		
CB/610	4.0, 5.5, 6.5 mm	
CB/250	PH1, PH2, PH3	
CB/350	PZ1, PZ2, PZ3	
CB/800	T10, T15, T20, T25, T27, T30, T40	
CB/1800	3, 4, 5, 6 mm	

SF99 Serisi

C-PLUS Tornavida Takımı Teşhir Setleri



KOD NO		FİYAT/TL
SF99-601	1	
12x F99-601		
SF99-602	1	
12x F99-602		
SF99-701	1	
12x F99-701		
SF99-702	1	
12x F99-702		
SF99-601V	1	
12x F99-601V		
SF99-602V	1	
12x F99-602V		

F99C-600 Serisi

6 Parça C-PLUS Tornavida Takımı (Çekiçlenebilir)

x4

x2

**C-PLUS Darbeli Tornavidalar**

darbeli kullanıma uygun dayanıklı tornavidalar

KOD NO		FİYAT/TL
F99C-601	1	
● F10C	5.5x100, 6.5x125, 8.0x150, 10x175 mm	
⊕ F14C	PH2x100, PH3x150 mm	
F99C-602	1	
● F10C	5.5x100, 6.5x125, 8.0x150, 10x175 mm	
⊕ F17C	PZ2x100, PZ3x150 mm	

**F10C Serisi**

C-PLUS Düz Uçlu Tornavidalar (Çekiçlenebilir)

yeni

* Sıkma somunu yoktur



KOD NO	Ø mm	mm	FİYAT/TL
F10C-045-100*	4.5	100	12
F10C-055-100	5.5	100	12
F10C-065-125	6.5	125	12
F10C-080-150	8.0	150	12
F10C-100-175	10.0	175	12
F10C-120-200*	12.0	200	12

F14C Serisi

C-PLUS Yıldız Uçlu Tornavidalar (Çekiçlenebilir)

yeni

KOD NO	+	mm	FİYAT/TL
F14C-001-080	PH1	80	12
F14C-002-100	PH2	100	12
F14C-003-150	PH3	150	12

F17C Serisi

C-PLUS Pozitiv Uçlu Tornavidalar (Çekiçlenebilir)

yeni

KOD NO	+	mm	FİYAT/TL
F17C-001-080	PZ1	80	12
F17C-002-100	PZ2	100	12
F17C-003-150	PZ3	150	12

F99D-600 Serisi

6 Parça C-PLUS Tornavida Takımı (Elmas Uçlu)



x4

x2

**C-PLUS Elmas Uçlu Tornavidalar**

Vidayı kavrayan tornavidalar

KOD NO		FİYAT/TL
F99D-601	1	
● F10D	3.0x75, 4.0x100, 5.5x125, 6.0x150 mm	
⊕ F14D	PH1x80, PH2x100 mm	
F99D-602	1	
● F10D	3.0x75, 4.0x100, 5.5x125, 6.0x150 mm	
⊕ F17D	PZ1x80, PZ2x100 mm	

Bu seri, uç kısmında küçük elmas parçacıkları bulunan uçlar içerir. Bu nedenle, hassas malzemeler üzerinde çalışırken sorunlara yol açabilen kayma önlenir.

**F10D Serisi**

C-PLUS Düz Uçlu Tornavidalar (Elmas Uçlu)

yeni

KOD NO	Ø mm	mm	FİYAT/TL
F10D-030-075	3.0	75	12
F10D-040-100	4.0	100	12
F10D-055-125	5.5	125	12
F10D-060-150	6.0	150	12
F10D-080-150	8.0	150	12

Topaç Serisi



F10D-060-025	6.0	25	12
--------------	-----	----	----

F14D Serisi

C-PLUS Yıldız Uçlu Tornavidalar (Elmas Uçlu)

yeni

KOD NO	+	mm	FİYAT/TL
F14D-001-080	PH1	80	12
F14D-002-100	PH2	100	12
F14D-003-150	PH3	150	12

Topaç Serisi



F14D-002-025	PH2	25	12
--------------	-----	----	----

F17D Serisi

C-PLUS Pozitiv Uçlu Tornavidalar (Elmas Uçlu)

yeni

KOD NO	+	mm	FİYAT/TL
F17D-001-080	PZ1	80	12
F17D-002-100	PZ2	100	12
F17D-003-150	PZ3	150	12

Topaç Serisi



F17D-002-025	PZ2	25	12
--------------	-----	----	----

5 Tornavidalar ve Bits Uçlar

4100M Serisi / C

TOREX Düz Uçlu Tornavidalar (Kabin Tipi)



KOD NO	Ø mm	mm	FİYAT/TL
4100/21M	2.5	75	12
4100/31M	3.0	75	12
4100/32M	3.0	100	12
4100/35M	3.5	100	12
4100/41M	4.0	75	12
4100/42M	4.0	100	12
4100/43M	4.0	125	12
4100/44M	4.0	150	12

Topaç Serisi



4100/TP40M	4.0	25	12
4100/TP55M	5.5	25	12
4100/TP65M	6.5	25	12

4100M Serisi / W

TOREX Düz Uçlu Tornavidalar (Atölye tipi)



KOD NO	Ø mm	mm	FİYAT/TL
4100/52M	5.5	100	12
4100/53M	5.5	125	12
4100/54M	5.5	150	12
4100/56M	5.5	200	12
4100/62M	6.5	100	12
4100/63M	6.5	125	12
4100/64M	6.5	150	12
4100/66M	6.5	200	12
4100/74M	8.0	150	12
4100/75M	8.0	175	12
4100/86M	10.0	200	12
4100/87M	10.0	250	12
4100/107M	12.0	250	12

4000M/4ST4

4 Parça TOREX Tornavida Takımı - Yıldız



KOD NO	FİYAT/TL
4000M/4ST4	1

4200M PH0x60, PH1x80, PH2x100, PH3x150 mm

4200M Serisi

TOREX Yıldız Uçlu Tornavidalar



KOD NO	+	mm	FİYAT/TL
4200/30M	PH0	60	12
4200/31M	PH0	80	12
4200/51M	PH1	80	12
4200/52M	PH1	100	12
4200/53M	PH1	125	12
4200/56M	PH1	200	12
4200/62M	PH2	100	12
4200/63M	PH2	125	12
4200/64M	PH2	150	12
4200/66M	PH2	200	12
4200/84M	PH3	150	12
4200/106M	PH4	200	12

Topaç Serisi



4200/TP1M	PH1	25	12
4200/TP2M	PH2	25	12

4300M Serisi

TOREX Pozitiv Uçlu Tornavidalar



KOD NO	+	mm	FİYAT/TL
4300/30M	PZ0	60	12
4300/51M	PZ1	80	12
4300/62M	PZ2	100	12
4300/84M	PZ3	150	12

Topaç Serisi



4300/TP1M	PZ1	25	12
4300/TP2M	PZ2	25	12

4400M Serisi

TOREX TORX Uçlu Tornavidalar



KOD NO	T	mm	FİYAT/TL
4400/T10M	T10	80	12
4400/T15M	T15	80	12
4400/T20M	T20	100	12
4400/T25M	T25	100	12
4400/T27M	T27	115	12
4400/T30M	T30	115	12
4400/T40M	T40	130	12

1300M Serisi

TOREX Lokma Uçlu Tornavidalar



KOD NO	mm	FİYAT/TL	
1304M	4	125	12
1305M	5	125	12
1355M	5.5	125	12
1306M	6	125	12
1307M	7	125	12
1308M	8	125	12
1309M	9	125	12
1310M	10	125	12
1311M	11	125	12
1312M	12	125	12
1313M	13	125	12
1314M	14	125	12

4000M/5ST3

5 Parça TOREX Tornavida Takımı - Düz



KOD NO	FİYAT/TL
4000M/5ST3	1

4100M 3.0x75, 4.0x100, 5.5x125, 6.5x150, 8.0x150 mm

1300M/5ST1

5 Parça TOREX Lokma Uçlu Tornavida Takımı



x5



KOD NO	FİYAT/TL
1300M/5ST1	1

● 1300M 6x125, 7x125, 8x125, 10x125, 13x125 mm

4000M/6ST1

6 Parça TOREX Tornavida Takımı - Düz/Yıldız



x4

x2



KOD NO	FİYAT/TL
4000M/6ST1	1

● 4100M 3.0x75, 4.0x100, 5.5x125, 6.5x150 mm
 ⊕ 4200M PH1x80, PH2x100 mm

4000M/6ST2

6 Parça TOREX Tornavida Takımı - Düz/Pozidriv

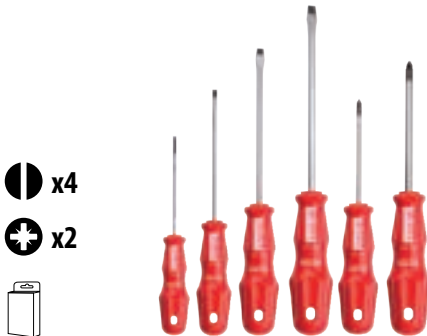

x4

x2



KOD NO	FİYAT/TL
4000M/6ST2	1

● 4100M 3.0x75, 4.0x100, 5.5x125, 6.5x150 mm
 ⊕ 4300M PZ1x80, PZ2x100 mm

4400M/6ST1

6 Parça TOREX Tornavida Takımı - TORX



x6



KOD NO	FİYAT/TL
4400M/6ST1	1

● 4400M T10x80, T15x80, T20x100, T25x100, T30x115, T40x130 mm

4000M/7ST1

7 Parça TOREX Tornavida Takımı - Düz/Yıldız



x4

x3



KOD NO	FİYAT/TL
4000M/7ST1	1

● 4100M 3.0x75, 4.0x100, 5.5x125, 6.5x150 mm
 ⊕ 4200M PH0x60, PH1x80, PH2x100 mm

4000M/7ST2

7 Parça TOREX Tornavida Takımı - Düz/Pozidriv



x4

x3



KOD NO	FİYAT/TL
4000M/7ST2	1

● 4100M 3.0x75, 4.0x100, 5.5x125, 6.5x150 mm
 ⊕ 4300M PZ0x60, PZ1x80, PZ2x100 mm

4000M/9ST1

9 Parça TOREX Tornavida Takımı (Deri Çantalı)



x5

x2

x2

KOD NO	FİYAT/TL
4000M/9ST1	1

● 4100M 3.0x75, 4.0x100, 5.5x125, 6.5x150 mm
 ⊕ 4200M PH1x80, PH2x100 mm
 ⊕ 4300M PZ1x80, PZ2x100 mm
 ● 6105CP Kontrol Kalem (Kısa)

S4000M/ST Serisi

TOREX Tornavida Takımı Teşhir Setleri



KOD NO	FİYAT/TL
S4000M/6ST1	1
12x 4000M/6ST1	
S4000M/6ST2	1
12x 4000M/6ST2	
S4000M/7ST1	1
12x 4000M/7ST1	
S4000M/7ST2	1
12x 4000M/7ST2	



Plastik Askı



Tornavidaları plastik askılı olarak sipariş etmek için standart ürün kodlarının sonuna "X" ekleyiniz. Plastik askı farkı brüt TL'dir.

5 Tornavidalar ve Bits Uçlar

8000Q/M15

15 Parça Multi-Sistem Takım



KOD NO		FİYAT/TL
8000Q/M15	1	
8246Q 4.0/6.0 mm	8002QH 1/4"x130 mm	
8312Q PH1/PH2		
8412Q PZ1/PZ2	CO2-H 5.5, 6, 7, 8, 10, 11, 12, 13 mm	
8500Q T15/T20, T25/T30		
8102Q 1/4"x175 mm		

8002QH

C-PLUS Teleskopik Tutucu Sap (Multi-Sistem Süngüler için)

Yeni tasarım



KOD NO		FİYAT/TL
8002QH	1/4 130 6	

8101Q

Multi-Sistem Bits Tutucu Adaptör (Teleskopik)



KOD NO		FİYAT/TL
8101Q	1/4 175 6	

8102Q

Multi-Sistem Lokma Adaptörü (Teleskopik)



6.3
1/4"

KOD NO		FİYAT/TL
8102Q	1/4 175 6	

8246Q

Multi-Sistem Düz Kombine Süngü (Teleskopik)



KOD NO		FİYAT/TL
8246Q	4.0/6.0 175 6	

8312Q

Multi-Sistem Yıldız Kombine Süngü (Teleskopik)



KOD NO		FİYAT/TL
8312Q	PH1 / PH2 175 6	

8412Q

Multi-Sistem Pozidriv Kombine Süngü (Teleskopik)



KOD NO		FİYAT/TL
8412Q	PZ1 / PZ2 175 6	

8500Q Serisi

Multi-Sistem TORX Kombine Süngüler (Teleskopik)



KOD NO		FİYAT/TL
8515Q	T15 / T20 175 6	
8525Q	T25 / T30 175 6	

8000/PH3

3 Parça Multi-Sistem Allen Takım



KOD NO	FİYAT/TL
8000/PH3	1

8800 3.0 / 4.0, 5.0/6.0 mm

8002 6x130 mm

FX-MD

Mıknatıslama Aleti



KOD NO	GxYxD/mm	FİYAT/TL
FX-MD	51x49x29 25	

3100/TF2

Değişken Uçlu Tornavida



KOD NO		FİYAT/TL
3100/TF2	PH2 / 6.0 175 12 •	

Z Serisi

Düz Uçlu Z Tornavidalar



KOD NO		FİYAT/TL
Z/40	4.0 100 12 •	
Z/55	5.5 125 12 •	

Z/12

Yıldız Uçlu Z Tornavida









KOD NO		FİYAT/TL
Z/12	PH1 x PH2 100 12 •	

Darbeli Kullanım için 1/4" Bits Uçlar

Ceta Form, darbeli vidalama makinalarının pazarda her geçen gün artan kullanımını değerlendirerek, darbeli kullanıma özel bits ve tutucu programını geliştirdi. Standart bits uçların yetersiz kaldığı bu özel kullanım alanında yeni serimiz rakipsiz performans sunar.

1/4
"

Ürün Performans Grafiği (Darbeli kullanımlarda)

Sistem	Kullanım Ömrü
	
	
	



En kuvvetli makinalarla bile kullanılabilir



CB/250TM Serisi

Yıldız Bits Uçlar (Darbeli Kullanım)



KOD NO	+	mm		FİYAT/TL
CB/251TM	PH1	25	12•	
CB/252TM	PH2	25	12•	
CB/253TM	PH3	25	12•	

CB/490TM Serisi

Yıldız Bits Uçlar (Darbeli Kullanım)



KOD NO	+	mm		FİYAT/TL
CB/491TM	PH1	50	12•	
CB/492TM	PH2	50	12•	
CB/493TM	PH3	50	12•	

CB/490TM Serisi - XL

PH2 Yıldız Bits Uçlar (Darbeli Kullanım) - Uzun Boylar



KOD NO	+	mm		FİYAT/TL
CB/702TM	PH2	70	12•	
CB/902TM	PH2	90	12•	

CB/350TM Serisi

Pozidriv Bits Uçlar (Darbeli Kullanım)



KOD NO	+	mm		FİYAT/TL
CB/351TM	PZ1	25	12•	
CB/352TM	PZ2	25	12•	
CB/353TM	PZ3	25	12•	

CB/590TM Serisi

Pozidriv Bits Uçlar (Darbeli Kullanım)



KOD NO	+	mm		FİYAT/TL
CB/591TM	PZ1	50	12•	
CB/592TM	PZ2	50	12•	
CB/593TM	PZ3	50	12•	

CB/590TM Serisi - XL

PZ2 Pozidriv Bits Uçlar (Darbeli Kullanım) - Uzun Boylar



KOD NO	+	mm		FİYAT/TL
CB/712TM	PZ2	70	12•	
CB/912TM	PZ2	90	12•	

CB/800TM Serisi

TORX Bits Uçlar (Darbeli Kullanım)



KOD NO		mm		FİYAT/TL
CB/806TM	T10	25	12•	
CB/807TM	T15	25	12•	
CB/808TM	T20	25	12•	
CB/809TM	T25	25	12•	
CB/811TM	T30	25	12•	
CB/812TM	T40	25	12•	

CB/820TM Serisi

TORX Bits Uçlar (Darbeli Kullanım)



KOD NO		mm		FİYAT/TL
CB/824TM	T10	50	12•	
CB/825TM	T15	50	12•	
CB/826TM	T20	50	12•	
CB/827TM	T25	50	12•	
CB/829TM	T30	50	12•	
CB/830TM	T40	50	12•	

BT/65 - TM Serisi

Manyetik Lokma Uçlar (Darbeli Kullanım)

yeni



KOD NO	mm	mm		FİYAT/TL
BT/0865TM	8	65	10•	
BT/1065TM	10	65	6•	
BT/1365TM	13	65	6•	

5 Tornavidalar ve Bits Uçlar

Renk Kodlamalı 1/4" Torsion Bits Uçlar

İstenen bits uca kolay ulaşım için renk kodları

1/4
"



TORX

Yıldız

Pozidriv

Düz

Allen

CB/250TC Serisi

Yıldız Bits Uçlar (Renk Kodlamalı)



KOD NO	+	mm	mm	FİYAT/TL
CB/251TC	PH1	25	12•	
CB/252TC	PH2	25	12•	
CB/253TC	PH3	25	12•	

CB/800TC Serisi

TORX Bits Uçlar (Renk Kodlamalı)



KOD NO	+	mm	mm	FİYAT/TL
CB/806TC	T10	25	12•	
CB/807TC	T15	25	12•	
CB/808TC	T20	25	12•	
CB/809TC	T25	25	12•	
CB/811TC	T30	25	12•	
CB/812TC	T40	25	12•	

CB/590TC Serisi

Pozidriv Bits Uçlar (Renk Kodlamalı)



KOD NO	+	mm	mm	FİYAT/TL
CB/591TC	PZ1	50	12•	
CB/592TC	PZ2	50	12•	
CB/593TC	PZ3	50	12•	

CB/350TC Serisi

Pozidriv Bits Uçlar (Renk Kodlamalı)



KOD NO	+	mm	mm	FİYAT/TL
CB/351TC	PZ1	25	12•	
CB/352TC	PZ2	25	12•	
CB/353TC	PZ3	25	12•	

CB/1800TC Serisi

Allen Bits Uçlar (Renk Kodlamalı)



KOD NO	mm	mm	mm	FİYAT/TL
CB/1815TC	1.5	25	12•	
CB/1820TC	2	25	12•	
CB/1825TC	2.5	25	12•	
CB/1830TC	3	25	12•	
CB/1840TC	4	25	12•	
CB/1850TC	5	25	12•	
CB/1860TC	6	25	12•	

CB/ST31TC

31 Parça Bits Uç Takımı (Renk Kodlamalı)



KOD NO	mm	FİYAT/TL
CB/ST31TC	6	

CB/610TC 4.0, 5.5, 6.5 mm	CB/800TC T10, T15, 2xT20, 2xT25, T30, T40
CB/250TC 2xPH1, 3xPH2, PH3	CB/1800TC 1.5, 2, 2.5, 3, 4, 5, 6 mm
CB/350TC 2xPZ1, 3xPZ2, PZ3	BT/02

CB/600TC Serisi

Düz Bits Uçlar (Renk Kodlamalı)



KOD NO	mm	mm	mm	FİYAT/TL
CB/611TC	4.0	25	12•	
CB/612TC	5.5	25	12•	
CB/613TC	6.5	25	12•	

CB/490TC Serisi

Yıldız Bits Uçlar (Renk Kodlamalı)



KOD NO	+	mm	mm	FİYAT/TL
CB/491TC	PH1	50	12•	
CB/492TC	PH2	50	12•	
CB/493TC	PH3	50	12•	

CB/250 Serisi

Yıldız Bits Uçlar



KOD NO	+	mm		FİYAT/TL
CB/250	PH0	25	12 •	
CB/251	PH1	25	12 •	
CB/252	PH2	25	12 •	
CB/253	PH3	25	12 •	
CB/254	PH4	32	12 •	

CB/252D

Yıldız Bits Uç Toptan Paket (PH2) - 240 Adet



KOD NO			FİYAT/TL
CB/252D		1	
240x CB/252 (PH2)			

CB/250X Serisi

Yıldız Bits Uçlar (Teşhir Kartlı)



Belirtilen fiyatlar 3 adetli kart fiyatlarıdır

KOD NO	+	mm		FİYAT/TL
CB/251X	PH1	25	50 pk.	
CB/252X	PH2	25	50 pk.	
CB/253X	PH3	25	50 pk.	

CB/252DB

Şapkalı Yıldız Bits Uç (Alçıpan için)



KOD NO	+	mm		FİYAT/TL
CB/252DB	PH2	25	12 •	

CB/250B Serisi

Yıldız Bits Uçlar (50'li Pakette)



KOD NO	+	mm		FİYAT/TL
CB/251B	PH1	25	50 •	
CB/252B	PH2	25	50 •	
CB/253B	PH3	25	50 •	

CB/252BD

Yıldız Bits Uç Toptan Paket (PH2) - 500 Adet



KOD NO			FİYAT/TL
CB/252BD		1	
500x CB/252B (PH2)			

CB/262

Yıldız Bits Uç (Düşük Çap)



KOD NO	+	mm		FİYAT/TL
CB/262	PH2	25	12 •	

CB/350 Serisi

Pozidriv Bits Uçlar



KOD NO	+	mm		FİYAT/TL
CB/350	PZ0	25	12 •	
CB/351	PZ1	25	12 •	
CB/352	PZ2	25	12 •	
CB/353	PZ3	25	12 •	
CB/354	PZ4	32	12 •	

CB/352D

Pozidriv Bits Uç Toptan Paket (PZ2) - 240 Adet



KOD NO			FİYAT/TL
CB/352D		1	
240x CB/352 (PZ2)			

CB/350X Serisi

Pozidriv Bits Uçlar (Teşhir Kartlı)



Belirtilen fiyatlar 3 adetli kart fiyatlarıdır

KOD NO	+	mm		FİYAT/TL
CB/351X	PZ1	25	50 pk.	
CB/352X	PZ2	25	50 pk.	
CB/353X	PZ3	25	50 pk.	

5 Tornavidalar ve Bits Uçlar

CB/350B Serisi

Pozidriv Bits Uçlar (50'li Pakette)



EKONOMİK
PAKET



KOD NO	+	mm	mm	FİYAT/TL
CB/351B	PZ1	25	50 •	
CB/352B	PZ2	25	50 •	
CB/353B	PZ3	25	50 •	

CB/352BD

Pozidriv Bits Uç Toptan Paket (PZ2) - 500 Adet

ÇOK AL
AZ ÖDE



KOD NO	mm	FİYAT/TL
CB/352BD	1	
500x CB/352B (PZ2)		

CB/610 Serisi

Düz Bits Uçlar



KOD NO	mm	mm	mm	FİYAT/TL
CB/610	3.0	25	12 •	
CB/611	4.0	25	12 •	
CB/612	5.5	25	12 •	
CB/613	6.5	25	12 •	

CB/660 Serisi

Çift Taraflı Bits Uçlar



KOD NO	ÖLÇÜ	TIP	mm	FİYAT/TL
CB/660P1S4	PH1 / 4.0	+	30	12 •
CB/660P2S5	PH2 / 5.0	+	30	12 •
CB/660Z1H4	PZ1 / 4.0	+	30	12 •
CB/660Z2H5	PZ2 / 5.0	+	30	12 •
CB/660S6H6	6.0 / 6.0	+	30	12 •
CB/660T2T3	T20 / T30	+	30	12 •

CB/800 Serisi

TORX Bits Uçlar



KOD NO	+	mm	mm	FİYAT/TL
CB/801	T05	25	12 •	
CB/802	T06	25	12 •	
CB/803	T07	25	12 •	
CB/804	T08	25	12 •	
CB/805	T09	25	12 •	
CB/806	T10	25	12 •	
CB/807	T15	25	12 •	
CB/808	T20	25	12 •	
CB/809	T25	25	12 •	
CB/810	T27	25	12 •	
CB/811	T30	25	12 •	
CB/812	T40	25	12 •	
CB/813	T45	35	12 •	
CB/814	T50	35	12 •	

CB/800X Serisi

TORX Bits Uçlar (Teşhir Kartlı)



Belirtilen fiyatlar 3 adetli kart fiyatlarıdır

KOD NO	+	mm	mm	FİYAT/TL
CB/806X	T10	25	50 pk.	
CB/807X	T15	25	50 pk.	
CB/808X	T20	25	50 pk.	
CB/809X	T25	25	50 pk.	
CB/811X	T30	25	50 pk.	
CB/812X	T40	25	50 pk.	

CB/800T Serisi

Delikli TORX Bits Uçlar



KOD NO	+	mm	mm	FİYAT/TL
CB/806T	T10	25	12 •	
CB/807T	T15	25	12 •	
CB/808T	T20	25	12 •	
CB/809T	T25	25	12 •	
CB/810T	T27	25	12 •	
CB/811T	T30	25	12 •	
CB/812T	T40	25	12 •	

CB/800B Serisi

TORX Bits Uçlar (50'li Pakette)



EKONOMİK
PAKET



KOD NO	+	mm	mm	FİYAT/TL
CB/808B	T20	25	50 •	
CB/809B	T25	25	50 •	
CB/811B	T30	25	50 •	

CB/800BD Serisi

TORX Bits Uç Toptan Paketleri - 500 Adet

ÇOK AL
AZ ÖDE



KOD NO	mm	FİYAT/TL
CB/808BD	1	
500x CB/808B (T20)		
CB/809BD	1	
500x CB/809B (T25)		
CB/811BD	1	
500x CB/811B (T30)		

CB/800IP Serisi

TORX PLUS Bits Uçlar



KOD NO	+	mm	mm	FİYAT/TL
CB/806IP	IP10	25	12 •	
CB/807IP	IP15	25	12 •	
CB/808IP	IP20	25	12 •	
CB/809IP	IP25	25	12 •	
CB/811IP	IP30	25	12 •	
CB/812IP	IP40	25	12 •	

CB/800IPR Serisi

5 Köşe Delikli TORX Bits Uçlar



KOD NO	+	mm	mm	FİYAT/TL
CB/806IPR	IPR10	25	12 •	
CB/807IPR	IPR15	25	12 •	
CB/808IPR	IPR20	25	12 •	
CB/809IPR	IPR25	25	12 •	
CB/810IPR	IPR27	25	12 •	
CB/811IPR	IPR30	25	12 •	
CB/812IPR	IPR40	25	12 •	

CB/840 Serisi

Kare Bits Uçlar



KOD NO	□	mm	📦	FİYAT/TL
CB/841	No.1	25	12•	
CB/842	No.2	25	12•	
CB/843	No.3	25	12•	

CB/1800 Serisi

Allen Bits Uçlar



KOD NO	⊙mm	mm	📦	FİYAT/TL
CB/1815	1.5	25	12•	
CB/1820	2	25	12•	
CB/1825	2.5	25	12•	
CB/1830	3	25	12•	
CB/1835	3.5	25	12•	
CB/1840	4	25	12•	
CB/1850	5	25	12•	
CB/1860	6	25	12•	
CB/1880	8	25	6•	
CB/1810	10	25	6•	

CB/850 Serisi

XZN Bits Uçlar



KOD NO	⊙	mm	📦	FİYAT/TL
CB/854	M4	25	12•	
CB/855	M5	25	12•	
CB/856	M6	25	12•	
CB/858	M8	25	6•	

CB/1800 Serisi - SAE

Allen Bits Uçlar - SAE



KOD NO	⊙"	mm	📦	FİYAT/TL
CB/180332	3/32	25	12•	
CB/180108	1/8	25	12•	
CB/180964	9/64	25	12•	
CB/180532	5/32	25	12•	
CB/180316	3/16	25	12•	
CB/180732	7/32	25	12•	
CB/180104	1/4	25	12•	

CB/SP Serisi

Anahtar Tip Güvenlik Bits Uçlar

yeni



KIOD NO	⊙	mm	📦	FİYAT/TL
CB/SP04	4	25	12•	
CB/SP06	6	25	12•	
CB/SP08	8	25	12•	
CB/SP10	10	25	12•	

CB/SVB25

Schrader Sibop İğneleri için Bits Uç



KOD NO	⊙mm	mm	📦	FİYAT/TL
CB/SVB25	4	25	12•	

**HAVACILIK
BİTS UÇLARI****CB/870 Serisi**

TRI-WING Bits Uçlar



KOD NO	🌀	mm	📦	FİYAT/TL
CB/871	TW1	25	12•	
CB/872	TW2	25	12•	
CB/873	TW3	25	12•	
CB/874	TW4	25	12•	
CB/875	TW5	25	12•	

CB/860 Serisi

TORQ-SET Bits Uçlar (25 mm)



KOD NO	+	mm	📦	FİYAT/TL
CB/860	No.0	25	12•	
CB/861	No.1	25	12•	
CB/862	No.2	25	12•	
CB/863	No.3	25	12•	
CB/864	No.4	25	12•	
CB/865	No.5	25	12•	
CB/866	No.6	25	12•	
CB/867	No.8	25	12•	
CB/868	No.10	25	12•	
CB/869	1/4"	25	12•	

CB/860510

TORQ-SET Bits Uç (50 mm)



KOD NO	+	mm	📦	FİYAT/TL
CB/860510	No.10	50	12•	

CB/8603 Serisi

TORQ-SET Bits Uçlar (32 mm)



KOD NO	+	mm	📦	FİYAT/TL
CB/860300	No.0	32	12•	
CB/860301	No.1	32	12•	
CB/860302	No.2	32	12•	
CB/860303	No.3	32	12•	
CB/860304	No.4	32	12•	
CB/860305	No.5	32	12•	
CB/860306	No.6	32	12•	
CB/860308	No.8	32	12•	
CB/860310	No.10	32	12•	
CB/860314	1/4"	32	6•	

CB/8613 Serisi

TORQ-SET Bits Uçlar (32 mm)



KOD NO	+	mm	📦	FİYAT/TL
CB/861314	1/4"	32	6•	
CB/861351	5/16"	32	6•	

5 Tornavidalar ve Bits Uçlar

CB/490 Serisi

Yıldız Bits Uçlar



KOD NO	+	mm		FİYAT/TL
CB/491	PH1	50	12 •	
CB/492	PH2	50	12 •	
CB/493	PH3	50	12 •	

CB/492D

Yıldız Bits Uç Toptan Paket (PH2) - 240 Adet



KOD NO		FİYAT/TL
CB/492D	1	
240x CB/492 (PH2)		

CB/490X Serisi

Yıldız Bits Uçlar (Teşhir Kartlı)



Belirtilen fiyatlar 3 adetli kart fiyatlarıdır

KOD NO	+	mm		FİYAT/TL
CB/491X	PH1	50	50 pk.	
CB/492X	PH2	50	50 pk.	
CB/493X	PH3	50	50 pk.	

CB/662TM

Çift Taraflı Yıldız Bits Uç (Torsion)



KOD NO	+	mm		FİYAT/TL
CB/662TM	PH2 / PH2	65	12 •	

CB/490B Serisi

Yıldız Bits Uçlar (50'li Pakette)



KOD NO	+	mm		FİYAT/TL
CB/491B	PH1	50	50 •	
CB/492B	PH2	50	50 •	
CB/493B	PH3	50	50 •	

CB/492BD

Yıldız Bits Uç Toptan Paket (PH2) - 500 Adet



KOD NO		FİYAT/TL
CB/492BD	1	
500x CB/492B (PH2)		

CB/XL Serisi - PH

Yıldız Bits Uçlar - Uzun Boylar

DIN ISO 8764-1, TS 8748-2
DIN 3126-E 6.3, ISO 1173



KOD NO	+	mm		FİYAT/TL
CB/701	PH1	70	12 •	
CB/702	PH2	70	12 •	
CB/703	PH3	70	12 •	
CB/901	PH1	90	12 •	
CB/902	PH2	90	12 •	
CB/903	PH3	90	12 •	
CB/1101	PH1	110	12 •	
CB/1102	PH2	110	12 •	
CB/1103	PH3	110	12 •	
CB/1271	PH1	127	10 •	
CB/1272	PH2	127	10 •	
CB/1273	PH3	127	10 •	
CB/1521	PH1	150	10 •	
CB/1522	PH2	150	10 •	
CB/1523	PH3	150	10 •	
CB/2022	PH2	200	10 •	

CB/590 Serisi

Pozidriv Bits Uçlar



KOD NO	+	mm		FİYAT/TL
CB/591	PZ1	50	12 •	
CB/592	PZ2	50	12 •	
CB/593	PZ3	50	12 •	

CB/592D

Pozidriv Bits Uç Toptan Paket (PZ2) - 240 Adet



KOD NO		FİYAT/TL
CB/592D	1	
240x CB/592 (PZ2)		

CB/590X Serisi

Pozidriv Bits Uçlar (Teşhir Kartlı)



Belirtilen fiyatlar 3 adetli kart fiyatlarıdır

KOD NO	+	mm		FİYAT/TL
CB/591X	PZ1	50	50 pk.	
CB/592X	PZ2	50	50 pk.	
CB/593X	PZ3	50	50 pk.	

CB/590B Serisi

Pozidriv Bits Uçlar (50'li Pakette)

**EKONOMİK
PAKET**

KOD NO	+	mm	mm	FİYAT/TL
CB/591B	PZ1	50	50 •	
CB/592B	PZ2	50	50 •	
CB/593B	PZ3	50	50 •	

CB/592BD

Pozidriv Bits Uç Toptan Paket (PZ2) - 500 Adet

**ÇOK AL
AZ ÖDE**

KOD NO	+	mm	mm	FİYAT/TL
CB/592BD			1	
500x CB/592B (PZ2)				

CB/XL Serisi - PZ

Pozidriv Bits Uçlar - Uzun Boylar



KOD NO	+	mm	mm	FİYAT/TL
CB/711	PZ1	70	12 •	
CB/712	PZ2	70	12 •	
CB/713	PZ3	70	12 •	
CB/911	PZ1	90	12 •	
CB/912	PZ2	90	12 •	
CB/913	PZ3	90	12 •	

CB/820 Serisi

TORX Bits Uçlar



KOD NO	*	mm	mm	FİYAT/TL
CB/820	T06	50	12 •	
CB/821	T07	50	12 •	
CB/822	T08	50	12 •	
CB/823	T09	50	12 •	
CB/824	T10	50	12 •	
CB/825	T15	50	12 •	
CB/826	T20	50	12 •	
CB/827	T25	50	12 •	
CB/828	T27	50	12 •	
CB/829	T30	50	12 •	
CB/830	T40	50	12 •	

CB/820X Serisi

TORX Bits Uçlar (Teşhir Kartlı)



Belirtilen fiyatlar 3 adetli kart fiyatıdır

KOD NO	*	mm	mm	FİYAT/TL
CB/824X	T10	50	50 pk.	
CB/825X	T15	50	50 pk.	
CB/826X	T20	50	50 pk.	
CB/827X	T25	50	50 pk.	
CB/829X	T30	50	50 pk.	
CB/830X	T40	50	50 pk.	

CB/XL Serisi - TORX

TORX Bits Uçlar - Extra Uzun

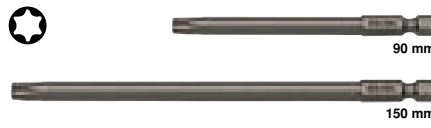

KOD NO	*	mm	mm	FİYAT/TL
CB/8094	T10	90	12 •	
CB/8095	T15	90	12 •	
CB/8096	T20	90	12 •	
CB/8097	T25	90	12 •	
CB/8099	T30	90	12 •	
CB/8156	T20	150	10 •	
CB/8157	T25	150	10 •	
CB/8159	T30	150	10 •	

CB/820B Serisi

TORX Bits Uçlar (50'li Pakette)

**EKONOMİK
PAKET**

KOD NO	*	mm	mm	FİYAT/TL
CB/826B	T20	50	50 •	
CB/827B	T25	50	50 •	
CB/829B	T30	50	50 •	

CB/820BD Serisi

TORX Bits Uç Teşhir Paketleri - 500 Adet

**ÇOK AL
AZ ÖDE**

KOD NO	*	mm	mm	FİYAT/TL
CB/826BD			1	
500x CB/826B (T20)				
CB/827BD			1	
500x CB/827B (T25)				
CB/829BD			1	
500x CB/829B (T30)				

CB/600 Serisi

Düz Bits Uçlar



KOD NO	mm	mm	mm	FİYAT/TL
CB/619	3.0	50	12 •	
CB/620	4.0	50	12 •	
CB/621	5.5	50	12 •	
CB/622	6.5	50	12 •	
CB/690	4.0	90	12 •	

5 Tornavidalar ve Bits Uçlar

CB/1900 Serisi

Allen Bits Uçlar



KOD NO	Ømm	mm	📦	FİYAT/TL
CB/1915	1.5	50	12•	
CB/1920	2	50	12•	
CB/1925	2.5	50	12•	
CB/1930	3	50	12•	
CB/1940	4	50	12•	
CB/1950	5	50	12•	
CB/1960	6	50	12•	
CB/1980	8	50	6•	

CB/1900 Serisi - SAE

Allen Bits Uçlar



KOD NO	Ø"	mm	📦	FİYAT/TL
CB/190332	3/32	50	12•	
CB/190532	5/32	50	12•	
CB/190316	3/16	50	12•	

CB/8800 Serisi

Manyetik Lokma Uçlar



KOD NO	Ømm	mm	📦	FİYAT/TL
CB/8806	6	33	12•	
CB/8807	7	33	12•	

BT/42 Serisi

Manyetik Lokma Uçlar - 42/45 mm



KOD NO	Ømm	mm	📦	FİYAT/TL
BT/0542	5	42	12•	
BT/0642	6	42	12•	
BT/0742	7	42	12•	
BT/0842	8	42	12•	
BT/1045	10	45	12•	

📦 Teşhir kartlı sipariş için = Ürün Kodu + X
Sadece BT/0842 ve BT/1045 için

📦 Kart Bedeli
12

BTA/42 Serisi

Manyetik Lokma Uçlar - SAE



KOD NO	Ø"	mm	📦	FİYAT/TL
BTA/010442	1/4	42	6•	
BTA/051642	5/16	42	6•	
BTA/010245	1/2	45	6•	

BT/65 Serisi

Manyetik Lokma Uçlar - 65 mm



KOD NO	Ømm	mm	📦	FİYAT/TL
BT/0665	6	65	12•	
BT/0765	7	65	10•	
BT/0865	8	65	10•	
BT/1065	10	65	8•	
BT/1165	11	65	4•	
BT/1265	12	65	4•	
BT/1365	13	65	4•	
BT/1465	14	65	4•	
BT/1765	17	65	3•	

📦 Teşhir kartlı sipariş için = Ürün Kodu + X
Sadece BT/0865 ve BT/1065 için

📦 Kart Bedeli
12

BT/ST061

6 Parça Manyetik Lokma Uç Takımı - 65 mm



KOD NO	📦	FİYAT/TL
BT/ST061	6	

BT/65 6PC 6, 7, 8, 10, 12, 13 mm

BTD Serisi

Derin Lokma Uçlar



KOD NO	Ømm	mm	📦	FİYAT/TL
BTD/08	8	90	6•	
BTD/10	10	90	6•	
BTD/13	13	110	6•	



CB4/EST28

28 Parça Şarjlı Mikro Bits Tornavida Takımı

yeni

KOD NO	FİYAT/TL
CB4/EST28	1

- CB/PH - H4 PH000, PH00, PH0, PH1, PH2
- CB/TH - H4 T5, T6, T8, T10, T15
- CB/SL - H4 1.5, 2.0, 3.0, 4.0 mm
- CB/TX - H4 T2, T3, T4
- CB/HX - H4 1.5, 2.0 mm
- CB/TY - H4 1.0
- CB/PL - H4 P2, P5
- CB/SP - H4 2.6
- CB/TR - H4 2.3



Şarjlı Bits Tornavidası



Çift Amaçlı Levye



0.5 m Şarj Kablosu



Mıknatıslama Aleti

- LED AYDINLATMA
- MİKNATISLI TABAN VE ARKA
- 1 SAAT ÇALIŞMA SÜRESİ
- ELLE VE ELEKTRİKLİ KULLANIM
- USB Tip C

CB4/ST25

25 Parça Mikro Bits Uç Takımı

yeni

KOD NO	FİYAT/TL
CB4/ST25	1
F26A/BT4	CB/HX - H4 1.5, 2.0 mm
CB/PH - H4 PH000, PH00, PH0, PH1, PH2	CB/PL - H4 P2, P5
CB/SL - H4 1.5, 2.0, 3.0, 4.0 mm	CB/TY - H4 1.0
CB/TX - H4 T2, T3, T4	CB/TR - H4 2.3
CB/TH - H4 T5, T6, T8, T10, T15	CB/SP - H4 2.6

F26A/BT4

Mikro Bits Tutucu Tornavida (Alüminyum)

yeni

KOD NO	FİYAT/TL
F26A/BT4	125

CB/PH - H4 Serisi

Yıldız Mikro Bits Uçlar

yeni

KOD NO	FİYAT/TL
CB/PH30H4	28
CB/PH20H4	28
CB/PH10H4	28
CB/PH01H4	28
CB/PH02H4	28

CB/SL - H4 Serisi

Düz Mikro Bits Uçlar

yeni

KOD NO	FİYAT/TL
CB/SL10H4	28
CB/SL15H4	28
CB/SL20H4	28
CB/SL25H4	28
CB/SL30H4	28
CB/SL35H4	28
CB/SL40H4	28

CB4/ST49

49 Parça Mikro Bits Uç Takımı

yeni

KOD NO	FİYAT/TL
CB4/ST49	1
F26A/BT4	CB/PL - H4 P2, P5, P6
CB/PH - H4 PH000, PH00, PH0, PH1, PH2	CB/TY - H4 1.0, 2.0, 2.5
CB/SL - H4 1.0, 1.5, 2.0, 2.5, 3.0, 3.5, 4.0 mm	CB/TR - H4 2.0, 2.3, 3.0
CB/TX - H4 T2, T3, T4	CB/SP - H4 2.6, 3.0
CB/TH - H4 T5, T6, T7, T8, T9, T10, T15, T20	CB/SIM - H4 0.8
CB/HX - H4 0.7, 0.9, 1.3, 1.5, 2.0, 2.5, 3.0, 3.5, 4.0 mm	CB/MID - H4 2.5
	CB/SQ - H4 S0, S1, S2

CB/TX - H4 Serisi

TORX Mikro Bits Uçlar

yeni

KOD NO	FİYAT/TL
CB/TX02H4	28
CB/TX03H4	28
CB/TX04H4	28

CB/TH - H4 Serisi

Delikli TORX Mikro Bits Uçlar

yeni

KOD NO	FİYAT/TL
CB/TH05H4	28
CB/TH06H4	28
CB/TH07H4	28
CB/TH08H4	28
CB/TH09H4	28
CB/TH10H4	28
CB/TH15H4	28
CB/TH20H4	28

5 Tornavidalar ve Bits Uçlar

CB/HX - H4 Serisi

Allen Hassas Bits Uçlar

yeni



KOD NO	mm	mm	FİYAT/TL
CB/HX07H4	0.7	28	50•
CB/HX09H4	0.9	28	50•
CB/HX13H4	1.3	28	50•
CB/HX15H4	1.5	28	50•
CB/HX20H4	2.0	28	50•
CB/HX25H4	2.5	28	50•
CB/HX30H4	3.0	28	50•
CB/HX40H4	4.0	28	50•

CB/PL - H4 Serisi

5 Köşe PENTALOBE Hassas Bits Uçlar

yeni



KOD NO	mm	mm	FİYAT/TL
CB/PL02H4	P2	28	12•
CB/PL05H4	P5	28	12•
CB/PL06H4	P6	28	12•

CB/TY - H4 Serisi

Tri Point Hassas Bits Uçlar

yeni



KOD NO	mm	mm	FİYAT/TL
CB/TY30H4	0.6	28	12•
CB/TY20H4	1.0	28	12•
CB/TY10H4	2.0	28	12•
CB/TY01H4	2.5	28	12•

CB/TR - H4 Serisi

Üçgen Hassas Bits Uçlar

yeni



KOD NO	mm	mm	FİYAT/TL
CB/TR20H4	2.0	28	12•
CB/TR23H4	2.3	28	12•
CB/TR30H4	3.0	28	12•

CB/SP - H4 Serisi

Anahtar Tip Mikro Bits Uçlar

yeni



KOD NO	mm	mm	FİYAT/TL
CB/SP06H4	2.6	28	12•
CB/SP08H4	3.0	28	12•

F28-P12

12 Parça Darbeli Bits Tornavida Takımı



KOD NO	FİYAT/TL
F28-P12	1
CB/516SL 10 mm	CB/516TX T30, T40, T45, T50
CB/516PH PH2, PH3, PH4	CB/516HX 5, 6, 8 mm
F28/BT 5/16" Darbeli Bits Tornavidası	

F28/BT

5/16" Darbeli Bits Tornavidası



KOD NO	mm	FİYAT/TL
F28/BT	145	1

CB/516SL Serisi

Düz Bits Uçlar (Darbeli Kullanıma Uygun)



KOD NO	mm	mm	FİYAT/TL
CB/516SL08	8	30	6•
CB/516SL10	10	30	6•
CB/516SL12	12	30	6•

CB/516PH Serisi

Yıldız Bits Uçlar (Darbeli Kullanıma Uygun)

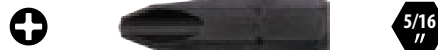

KOD NO	mm	FİYAT/TL
CB/516PH2	PH2	30 6•
CB/516PH3	PH3	30 6•
CB/516PH4	PH4	30 6•

CB/516PZ Serisi

Pozitrid Bits Uçlar (Darbeli Kullanıma Uygun)



KOD NO	mm	FİYAT/TL
CB/516PZ2	PZ2	30 6•
CB/516PZ3	PZ3	30 6•
CB/516PZ4	PZ4	30 6•

CB/516TX Serisi

TORX Bits Uçlar (Darbeli Kullanıma Uygun)



KOD NO	mm	FİYAT/TL
CB/516TX20	T20	30 6•
CB/516TX25	T25	30 6•
CB/516TX30	T30	30 6•
CB/516TX40	T40	30 6•
CB/516TX45	T45	30 6•
CB/516TX50	T50	30 6•
CB/516TX55	T55	30 6•

CB/516HX Serisi

Allen Bits Uçlar (Darbeli Kullanıma Uygun)



KOD NO	mm	mm	FİYAT/TL
CB/516HX05	5	30	6•
CB/516HX06	6	30	6•
CB/516HX07	7	30	6•
CB/516HX08	8	30	6•
CB/516HX10	10	30	6•
CB/516HX12	12	30	6•
CB/516HX14	14	30	3•

CB/516XZ06

XZN Bits Uç (Darbeli Kullanıma Uygun)



KOD NO	mm	FİYAT/TL
CB/516XZ06	M06	30 6•

CB/1000G Serisi

TORX Bits Uçlar - Kısa Tip



KOD NO		mm		FİYAT/TL
CB/1020G	T20	30	12•	
CB/1025G	T25	30	12•	
CB/1027G	T27	30	12•	
CB/1030G	T30	30	12•	
CB/1040G	T40	30	12•	
CB/1045G	T45	30	12•	
CB/1050G	T50	30	12•	
CB/1055G	T55	30	12•	

CB/1100G Serisi

TORX Bits Uçlar - Uzun Tip



KOD NO		mm		FİYAT/TL
CB/1120G	T20	75	10•	
CB/1125G	T25	75	10•	
CB/1127G	T27	75	10•	
CB/1130G	T30	75	10•	
CB/1140G	T40	75	10•	
CB/1145G	T45	75	10•	
CB/1150G	T50	75	10•	
CB/1155G	T55	75	10•	

CB/PH2M5

Yıldız Bits Uç (Vidalama Makineleri için)



KOD NO		mm		FİYAT/TL
CB/PH2M5	PH2	45	12•	

BT/7000 Serisi - M

1/4 6 Köşe Lokma Adaptörleri (Manuel Kullanım)



KOD NO		mm		FİYAT/TL
BT/7010	1/4 - 1/4	25	12•	
BT/7017M*	1/4 - 1/4	75	12•	
BT/7027*	3/8 - 1/4	75	6•	
BT/7028*	3/8 - 1/4	100	6•	

* Stoklarla sınırlıdır

CB/2000G Serisi

Allen Bits Uçlar - Kısa Tip



KOD NO	mm	mm		FİYAT/TL
CB/2004G	4	30	12•	
CB/2005G	5	30	12•	
CB/2006G	6	30	12•	
CB/2007G	7	30	12•	
CB/2008G	8	30	12•	
CB/2010G	10	30	12•	
CB/2012G	12	30	12•	

CB/2100G Serisi

Allen Bits Uçlar - Uzun Tip



KOD NO	mm	mm		FİYAT/TL
CB/2104G	4	75	10•	
CB/2105G	5	75	10•	
CB/2106G	6	75	10•	
CB/2107G	7	75	10•	
CB/2108G	8	75	10•	
CB/2110G	10	75	10•	
CB/2112G	12	75	6•	

CB/PZ2M5

Pozitiv Bits Uç (Vidalama Makineleri için)



KOD NO		mm		FİYAT/TL
CB/PZ2M5	PZ2	45	6•	

BT/7000 Serisi - P

1/4 6 Köşe Lokma Adaptörleri (Makina ile Kullanım)



KOD NO		mm		FİYAT/TL
BT/7015	1/4 1/4	50	12•	
BT/7018	1/4 1/4	100	12•	
BT/7020	3/8 1/4	50	6•	
BT/7030	1/2 1/4	50	6•	

CB/3000G Serisi

XZN Bits Uçlar - Kısa Tip



KOD NO		mm		FİYAT/TL
CB/3005G	M05	30	12•	
CB/3006G	M06	30	12•	
CB/3008G	M08	30	12•	
CB/3010G	M10	30	12•	
CB/3012G	M12	30	12•	

CB/3100G Serisi

XZN Bits Uçlar - Uzun Tip



KOD NO		mm		FİYAT/TL
CB/3105G	M05	75	10•	
CB/3106G	M06	75	10•	
CB/3108G	M08	75	10•	
CB/3110G	M10	75	10•	
CB/3112G	M12	75	6•	

CB/T M5 Serisi

TORX Bits Uçlar (Vidalama Makineleri için)



KOD NO		mm		FİYAT/TL
CB/T25M5	T25	45	6•	
CB/T30M5	T30	45	6•	

BT/7000S3

3 Parça Lokma Adaptör Takımı

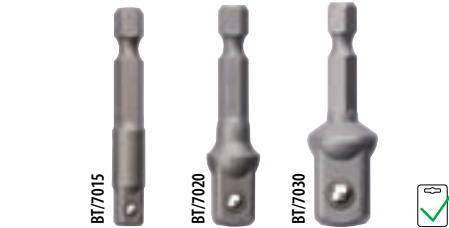

KOD NO		FİYAT/TL
BT/7000S3	10	

BT/7015 1/4"-1/4"
BT/7020 3/8"-1/4"
BT/7030 1/2"-1/4"



5 Tornavidalar ve Bits Uçlar

BT/01QH

Manyetik Bits Tutucu (Kilitli)



KOD NO	Ø"	mm	mm	FİYAT/TL
BT/01QH	1/4	60	6	

BT/01DUO

DUO Bits Tutucu (Lokma Adaptörlü)

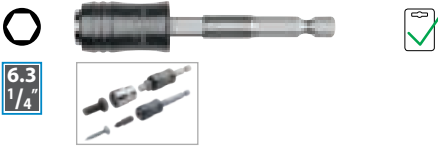

KOD NO	Ø"	mm	mm	FİYAT/TL
BT/01DUO	1/4	75-85	6	

BT/01SL2

Slim Manyetik Bits Tutucu (Vida Tutucu Adaptörlü)



KOD NO	Ø"	mm	mm	FİYAT/TL
BT/01SL2	14.8 - 11.0	73.4 - 67.2	6	

BT/00 Serisi

Manyetik Bits Tutucular



KOD NO	Ø"	mm	mm	FİYAT/TL
BT/02	1/4	60	10	
BT/03	1/4	75	10	
BT/05	1/4	150	10	

Teşhir kartı sipariş için = Ürün Kodu + X 10 Kart Bedeli

BT/08

SDS-Plus Bits Tutucu



KOD NO	Ø"	mm	mm	FİYAT/TL
BT/08	1/4	80	10	

Teşhir kartı sipariş için = Ürün Kodu + X 10 Kart Bedeli

F26/RDS

12-in-1 Cırcırlı Depolu Topaç Bits Tornavidası



KOD NO	Ø"	mm	mm	FİYAT/TL
F26/RDS	1/4	105	12	

F26/RDS 1/4" x 105 mm	CB/660P1S4 PH1/4.0 x 30 mm
CB/660S6H6 S6.0/6.0 x 30 mm	CB/660P2S5 PH2/5.0 x 30 mm
CB/660T2T3 T20/T30 x 30 mm	CB/660Z1H4 PZ1/4.0 x 30 mm
	CB/660Z2H5 PZ2/5.0 x 30 mm

F26/BDS

12-in-1 Depolu Topaç Bits Tornavidası



KOD NO	Ø"	mm	mm	FİYAT/TL
F26/BDS	1/4	90	12	

F26/BDS 1/4" x 90 mm	CB/660P1S4 PH1/4.0 x 30 mm
CB/660S6H6 S6.0/6.0 x 30 mm	CB/660P2S5 PH2/5.0 x 30 mm
CB/660T2T3 T20/T30 x 30 mm	CB/660Z1H4 PZ1/4.0 x 30 mm
	CB/660Z1H5 PZ2/5.0 x 30 mm

F26/RDS90

T90 Cırcırlı Topaç Bits Tornavidası



KOD NO	Ø"	mm	mm	FİYAT/TL
F26/RDS90	1/4	95	1	

F26/RDF90

T90 Cırcırlı Bits Tornavidası (Bits Depolu)



KOD NO	Ø"	mm	mm	FİYAT/TL
F26/RDF90	1/4	250	1	

CB/610 4.0, 5.5 mm	CB/250 PH1, PH2	CB/350 PZ1, PZ2
--------------------	-----------------	-----------------

3100/BT1

C-PLUS Bits Tutucu Tornavida



KOD NO	Ø"	mm	mm	FİYAT/TL
3100/BT1	1/4	100	12	

3100/BT6A

7 Parça Depolu Bits Tornavida Takımı



KOD NO	mm	FİYAT/TL
3100/BT6A	12	

3100/BT1 1/4" x 60 mm	CB/250 PH1, PH2
CB/610 4.0, 5.5, 6.5 mm	CB/350 PZ1

F26/BT Serisi

C-PLUS Bits Tutucu Tornavida



KOD NO	Ø"	mm	mm	FİYAT/TL
F26/BT	1/4	100	12	
F26/BTL	1/4	300	12	

F26/SBT

C-PLUS Bits Tutucu Tornavida (Kompakt)

yeni
tasarım

KOD NO				FİYAT/TL
F26/SBT	1/4	110	12	

F26/LBT

C-PLUS Bits Tutucu Tornavida (Kompakt - Kilitli)

yeni
tasarım

KOD NO				FİYAT/TL
F26/LBT	1/4	146	12	

F26/FBT

C-PLUS Bits Tutucu Tornavida (Bükülebilir Sıngürlü)

yeni
tasarım

KOD NO				FİYAT/TL
F26/FBT	1/4	150	12	

F26/TBT

T Saplı Bits Tutucu Tornavida



KOD NO				FİYAT/TL
F26/TBT	1/4	160	6	

F26/BR

Bits Cırcır Kolu No.1



KOD NO				FİYAT/TL
F26/BR	1/4	95	6	

F26/BR2

Bits Cırcır Kolu No.2



KOD NO				FİYAT/TL
F26/BR2	1/4	90	6	

F26/BR3

Bits Cırcır Kolu No.3

yeni
tasarım

KOD NO				FİYAT/TL
F26/BR3	1/4	100	6	

F26/AG

1/4" Delme ve Vidalama Köşe Adaptörü (90° Döner Kol)



KOD NO				FİYAT/TL
F26/AG	1/4	140	6	

F26/AG-2

1/4" Delme ve Vidalama Köşe Adaptörü (Sabit Kol)



KOD NO				FİYAT/TL
F26/AG-2	1/4	140	12	

BT/01XF

Esnek Gövdeli Bits Tutucu



KOD NO				FİYAT/TL
BT/01XF	1/4	300	10	

CB/ST31

31 Parça Bits Uç Takımı



KOD NO		FİYAT/TL
CB/ST31	6	

- CB/610 4.0, 5.5, 6.5 mm
- CB/250 2xPH1, 3xPH2, PH3
- CB/350 2xPZ1, 3xPZ2, PZ3
- BT/02
- CB/800 T10, T15, T20, T25, T27, T30, T40
- CB/800T T20, T30
- CB/1800 2, 2.5, 3, 4, 5, 6 mm

CB/ST25

25 Parça Lokma ve Bits Uç Takımı

**6.3**
1/4"

KOD NO		FİYAT/TL
CB/ST25	6	

- F26/BR2
- BT/02
- BT/7010
- CO2-H 6 PC
- CB/610 4.0, 6.5 mm
- CB/250 PH1, PH2
- CB/350 PZ1, PZ2
- CB/800 T10, T15, T20, T25, T30, T40
- CB/1800 3, 4, 5, 6 mm

5 Tornavidalar ve Bits Uçlar

CB/ST32

32 Parça Bits Tornavida Takımı



KOD NO	FİYAT/TL
CB/ST32	6
CB/610 4.0, 5.5, 6.5 mm	CB/800 T10, T15, T20, T25, T27, T30, T40
CB/250 2xPH1, 3xPH2, PH3	CB/800T T20, T30
CB/350 2xPZ1, 3xPZ2, PZ3	CB/1800 2, 2.5, 3, 4, 5, 6 mm
BT/02	F26/SBT 1/4"

CB/ST61

61 Parça Bits Uç Takımı



KOD NO	FİYAT/TL
CB/ST61	6
CB/610 4.0, 5.5, 6.5 mm	CB/800 T6, T7, T8, T9, T10, T15, 2xT20, T25, T27, 2xT30, T40
CB/250 PH0, PH1, 10xPH2, PH3	CB/800T T10, T15, T20, T25, T27, T30, T40
CB/350 PZ0, PZ1, 10xPZ2, PZ3	CB/800IPR IPR20
CB/840 No.1, No.2, No.3	BT/8001 1/4" - 1/4"
CB/1800 2, 2.5, 3, 4, 5, 6 mm	BT/02

CB/ST56

56 Parça Bits Tornavida Takımı



KOD NO	FİYAT/TL
CB/ST56	1
CB/610 4.0, 5.5, 6.5 mm	CB/1800 2, 2.5, 3, 4, 5, 6 mm
CB/250 PH0, PH1, PH2, PH3	CB/840 No.1, No.2, No.3
CB/350 PZ0, PZ1, PZ2, PZ3	CB/850 M5, M6, M8
CB/800 T6, T7, T8, T9, T10, T15, T20, T25, T27, T30, T40	CB/860 No.6, No.8, No.10
CB/800T T10, T15, T20, T25, T27, T30, T40	CB/870 TW1, TW2, TW3, TW4, TW5
CB/800IPR IPR20, IPR25, IPR30	BT/7010
F26/BT C-PLUS Bits Tutucu Tornavida	BT/8001 1/4" - 1/4"
BT/02	

CB/ST111

11 Parça Bits Uç Takımı - Düz/Yıldız/Pozidriv



KOD NO	FİYAT/TL
CB/ST111	6
CB/610 4.0, 6.5 mm	CB/250 PH1, 2xPH2, PH3
BT/02	CB/350 PZ1, 2xPZ2, PZ3

CB/ST113

11 Parça Bits Uç Takımı - TORX



KOD NO	FİYAT/TL
CB/ST113	6
CB/800 T6, T8, T9, T10, T15, T20, T25, T27, T30, T40	BT/02

CB/ST112

11 Parça Bits Uç Takımı - Yıldız/Pozidriv



KOD NO	FİYAT/TL
CB/ST112	6
CB/250 PH1, 3xPH2, PH3	BT/02
CB/350 PZ1, 3xPZ2, PZ3	

CB/ST113T

11 Parça Bits Uç Takımı - Delikli TORX



KOD NO	FİYAT/TL
CB/ST113T	6
CB/800T T10, T15, 2xT20, 2xT25, T27, 2xT30, T40	BT/02

CB/ST114

11 Parça Bits Uç Takımı - Allen



KOD NO	FİYAT/TL
CB/ST114	6
CB/1800 2, 2.5, 2x3, 2x4, 2x5, 2x6 mm	BT/02

6 Penseler ve Kesiciler

99 | 108



E01-11 Serisi

Kombine Penseler (Parlak Krom/DuoTech Sap)

yeni
tasarım



Forged in Germany

KOD NO	mm "	Ø mm	6	FİYAT/TL
E01-11-0160	160 - 6"	1.8	6	
E01-11-0180	180 - 7"	2.0	6	
E01-11-0200	200 - 8"	2.5	6	

E06-11 Serisi

Yan Kesiciler (Parlak Krom/DuoTech Sap)

yeni
tasarım



Forged in Germany

KOD NO	mm "	Ø mm	6	FİYAT/TL
E06-11-0140	140 - 5-1/2"	1.8	6	
E06-11-0160	160 - 6"	2.0	6	
E06-11-0180	180 - 7"	2.5	6	

E08-11 Serisi

Power Yan Kesiciler (Parlak Krom/DuoTech Sap)

yeni
tasarım



Forged in Germany

KOD NO	mm "	Ø mm	6	FİYAT/TL
E08-11-0180	180 - 7"	2.0	6	
E08-11-0200	200 - 8"	2.2	6	

E01-41 Serisi

Kombine Penseler (Polisajlı/DuoTech Sap)

yeni
tasarım



Forged in Germany

KOD NO	mm "	Ø mm	6	FİYAT/TL
E01-41-0160	160 - 6"	1.8	6	
E01-41-0180	180 - 7"	2.0	6	
E01-41-0200	200 - 8"	2.5	6	

E06-41 Serisi

Yan Kesiciler (Polisajlı/DuoTech Sap)

yeni
tasarım



Forged in Germany

KOD NO	mm "	Ø mm	6	FİYAT/TL
E06-41-0140	140 - 5-1/2"	1.8	6	
E06-41-0160	160 - 6"	2.0	6	
E06-41-0180	180 - 7"	2.5	6	

E08-41 Serisi

Power Yan Kesiciler (Polisajlı/DuoTech Sap)

yeni
tasarım



Forged in Germany

KOD NO	mm "	Ø mm	6	FİYAT/TL
E08-41-0180	180 - 7"	2.0	6	
E08-41-0200	200 - 8"	2.2	6	

E01-43 Serisi

Kombine Penseler (Polisajlı/UniGrip Sap)

yeni
tasarım



Forged in Germany

KOD NO	mm "	Ø mm	6	FİYAT/TL
E01-43-0160	160 - 6"	1.8	6	
E01-43-0180	180 - 7"	2.0	6	
E01-43-0200	200 - 8"	2.5	6	

E06-43 Serisi

Yan Kesiciler (Polisajlı/UniGrip Sap)

yeni
tasarım



Forged in Germany

KOD NO	mm "	Ø mm	6	FİYAT/TL
E06-43-0140	140 - 5-1/2"	1.8	6	
E06-43-0160	160 - 6"	2.0	6	
E06-43-0180	180 - 7"	2.5	6	

E09 Serisi

Plastik için Yan Kesiciler



Forged in Germany

KOD NO	mm "	6	FİYAT/TL
E09-44-0140	140 - 5-1/2"	6	
E09-44-0160	160 - 6"	6	

6 Penseler ve Kesiciler

SE11-24

24 Parça Pense Teşhir Paketi (DuoTech/Parlak Krom)

12x E01-11-0180
(180 mm)

12x E06-11-0160
(160 mm)

**ÇOK AL
AZ ÖDE**



KOD NO	FİYAT/TL
SE11-24	1

SE41-24

24 Parça Pense Teşhir Paketi (DuoTech/Polisajlı)

12x E01-41-0180
(180 mm)

12x E06-41-0160
(160 mm)

**ÇOK AL
AZ ÖDE**



KOD NO	FİYAT/TL
SE41-24	1

SE43-24

24 Parça Pense Teşhir Paketi (UniGrip/Polisajlı)



12x E01-43-0180
(180 mm)

12x E06-43-0160
(160 mm)

**ÇOK AL
AZ ÖDE**



KOD NO	FİYAT/TL
SE43-24	1

E99-41-02A

2 Parça Pense Takımı

E01-41-0180
(180 mm)

E06-41-0160
(160 mm)



KOD NO	FİYAT/TL
E99-41-02A	1

E99-41-03A

3 Parça Pense Takımı

E01-41-0180
(180 mm)

E06-41-0160
(160 mm)

E15-41-0160
(160 mm)



KOD NO	FİYAT/TL
E99-41-03A	1

E99-41-03B

3 Parça Pense Takımı (E30 Papağan Pense ile)

E01-41-0180
(180 mm)

E06-41-0160
(160 mm)

E30-54-0250
(250 mm)



KOD NO	FİYAT/TL
E99-41-03B	1

E99-41-W09 Serisi

9 Parça Pense-Tornavida Setleri (Deri Çantalı)



KOD NO	FİYAT/TL
E99-41-W09PH	1

E01-41-0180	F10 2.5x75, 4.0x100, 5.5x125 mm
E06-41-0160	F14 PH1x80, PH2x100 mm
E15-41-0160	6105CP Kontrol Kalem (Kısa)

E99-41-W09PZ	1
--------------	---

İçerik: E99-41-W09PH ile aynı fakat yıldız yerine Pozidriv tornavidalar içermektedir.

E05-44-0160

Amerikan Tip Pense



KOD NO	FİYAT/TL
E05-44-0160	6

E19D-200

Ördek Ağızlı Karga Burun



KOD NO	FİYAT/TL
E19D-200	6

E15-11 Serisi

Kargaburunlar (Parlak Krom/DuoTech Sap)



Forged in Germany

KOD NO	mm "	Ø mm	6	FİYAT/TL
E15-11-0160	160 - 6"	1.6	6	
E15-11-0200	200 - 8"	1.6	6	

E16-11 Serisi

Eğri Kargaburunlar (Parlak Krom/DuoTech Sap)



Forged in Germany

KOD NO	mm "	Ø mm	6	FİYAT/TL
E16-11-0160	160 - 6"	1.6	6	
E16-11-0200	200 - 8"	1.6	6	

E17-11-0160

Yassı Kargaburun (Parlak Krom/DuoTech Sap)



KOD NO	mm "	6	FİYAT/TL
E17-11-0160	160 - 6"	6	

E15-41 Serisi

Kargaburunlar (Polisajlı/DuoTech Sap)



Forged in Germany

KOD NO	mm "	Ø mm	6	FİYAT/TL
E15-41-0160	160 - 6"	1.6	6	
E15-41-0200	200 - 8"	1.6	6	

E16-41 Serisi

Eğri Kargaburunlar (Polisajlı/DuoTech Sap)



Forged in Germany

KOD NO	mm "	Ø mm	6	FİYAT/TL
E16-41-0160	160 - 6"	1.6	6	
E16-41-0200	200 - 8"	1.6	6	

E17-41-0160

Yassı Kargaburun (Polisajlı/DuoTech Sap)



KOD NO	mm "	6	FİYAT/TL
E17-41-0160	160 - 6"	6	

E15-43 Serisi

Kargaburunlar (Polisajlı/UniGrip Sap)



Forged in Germany

KOD NO	mm "	Ø mm	6	FİYAT/TL
E15-43-0160	160 - 6"	1.6	6	
E15-43-0200	200 - 8"	1.6	6	

E16-43 Serisi

Eğri Kargaburunlar (Polisajlı/UniGrip Sap)



Forged in Germany

KOD NO	mm "	Ø mm	6	FİYAT/TL
E16-43-0160	160 - 6"	1.6	6	
E16-43-0200	200 - 8"	1.6	6	

E18-11-0160

Yuvarlak Kargaburun (Parlak Krom/DuoTech Sap)



KOD NO	mm "	6	FİYAT/TL
E18-11-0160	160 - 6"	6	

E15XL-340

Ekstra Uzun Kargaburun (Çift Mafsallı)



KOD NO	mm	6	FİYAT/TL
E15XL-340	340	6	

E16XL-340

Ekstra Uzun Eğri Kargaburun (Çift Mafsallı)



KOD NO	mm	6	FİYAT/TL
E16XL-340	340	6	

E18-41-0160

Yuvarlak Kargaburun (Polisajlı/DuoTech Sap)



KOD NO	mm "	6	FİYAT/TL
E18-41-0160	160 - 6"	6	

6 Penseler ve Kesiciler

E25-11-0160

Kablo Sıyırma Pense (Parlak Krom/DuoTech Sap)



Forged in Germany

KOD NO	mm	mm ²	FİYAT/TL
E25-11-0160	160 - 6"	10	6

E25-41-0160

Kablo Sıyırma Pense (Polisajlı/DuoTech Sap)



Forged in Germany

KOD NO	mm	mm ²	FİYAT/TL
E25-41-0160	160 - 6"	10	6

E26-11-0160

Kablo Sıyırıcı Yan Keski (Parlak Krom/DuoTech Sap)



Forged in Germany

KOD NO	mm	mm ²	FİYAT/TL
E26-11-0160	160 - 6"	1.5, 2.5	6

E26-41-0160

Kablo Sıyırıcı Yan Keski (Polisajlı/DuoTech Sap)



Forged in Germany

KOD NO	mm	mm ²	FİYAT/TL
E26-41-0160	160 - 6"	1.5, 2.5	6

E25-MMAX

Çok Amaçlı Elektrikçi Pense

yeni tasarım

7 FONKSİYON TEK ALETTE



Forged in Germany

Kablo Sıyırma Kapasitesi : 0.75, 1.0, 1.5, 2.5 mm²
 Cıvata Kesme Kapasitesi : M3.5, M4
 İzolesiz Kablo Pabucu Sıkma Kapasitesi : 0.75, 1.0, 1.5, 2.5, 4.0 mm²
 İzolesiz Kablo Yüksüğü Sıkma Kapasitesi : 0.50, 0.75, 1.0, 1.5, 2.5 mm²
 Kablo Kesme Kapasitesi : Ø15 mm / 50 mm²
 Yassı ve Yuvarlak malzemeleri tutma, kablo bükme

KOD NO	mm	FİYAT/TL
E25-MMAX	225 - 9"	6

E25-BS Serisi

Otomatik Kablo Sıyırıcılar (Adaptif Ağızlı)



KOD NO	Ø	mm	FİYAT/TL
E25-BSM20	0.5, 1.2, 1.6, 2.0 mm	165	5
E25-BSA22	AWG 8, 10, 12, 14, 18, 22	165	5
E25-BSM20R	Yedek Bıçak (BSM20)		1
E25-BSA22R	Yedek Bıçak (BSA22)		1

E25-MULTI1

Çok Amaçlı Sıyırıcı / Ezici Pense



Kablo Sıyırma Kapasiteleri:
 AWG: 18/ 17/ 16/ 14/ 12/ 10
 Metrik: 1/ 1,2/ 1,3/ 1,6/ 2,0/ 2,6
 Cıvata Kesme Kapasiteleri:
 Inch :4-40, 5-40, 6-32, 8-32, 10-24, 10-32
 Metrik: M2,6, M3, M3,5, M4, M4,5, M5
 Kablo Pabucu Sıkma Kapasiteleri:
 16-10 AWG (2.5-1.3 mm) / 22-18 AWG (1.0-0.6 mm)

KOD NO	mm	FİYAT/TL
E25-MULTI1	210 - 8 1/4"	10

E25-AT1

Otomatik Kablo Sıyırıcı (DuoTech Sap)



KOD NO	mm	FİYAT/TL
E25-AT1	205 - 8"	6 10

E25-AS06

Otomatik Kablo Sıyırma Aleti

StripX



KOD NO	mm	mm ²	FİYAT/TL
E25-AS06	170 - 7"	0.2 - 6	6

E25-MIC

Mikro Kablo Sıyırıcı

StripX

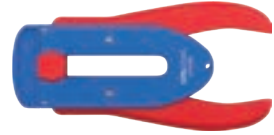

KOD NO	mm	mm ²	FİYAT/TL
E25-MIC	112	0.16-0.8	6

E25-CK28

Kablo Soyma Aleti

StripX



KOD NO	mm	mm ²	FİYAT/TL
E25-CK28	140 - 5 1/2"	8-28	12

E25-CK28H

Kablo Soyma Aleti (Kanca Bıçaklı)

StripX



KOD NO	mm	mm ²	FİYAT/TL
E25-CK28H	185 - 7"	4-28	12

E25-CK28R

Kablo Soyma Yedek Ucu



KOD NO	YEDEK UÇ	FİYAT/TL
E25-CK28R	E25-CK28 & E25-CK28H için	6*

E25-COS

Koaksiyel Kablo Sıyırıcı

StripX



KOD NO	mm	mm ²	FİYAT/TL
E25-COS	110 - 4"	4.8 - 7.5	12

E30-51-0250

Papağan Pense (Kutu Mafsal-DuoTech Sap)



Forged in Germany

KOD NO	mm "	max. mm		FİYAT/TL
E30-51-0250	250 - 10"	50	6	

E30-54 Serisi

Papağan Penseler (Kutu Mafsal-PVC Daldırma Sap)



Forged in Germany

KOD NO	mm "	max. mm		FİYAT/TL
E30-54-0250	250 - 10"	50	6	
E30-54-0300	300 - 12"	70	6	

E30W-54-0250

Anahtar Fonksiyonlu Pense (Paralel Çene)



KOD NO	mm "	mm		FİYAT/TL
E30W-54-0250	250 - 10"	42	6	

E29-54-0250

Otomatik Ayarlı Papağan Pense



KOD NO	mm "	max. mm		FİYAT/TL
E29-54-0250	250 - 10"	35	6	

E30Q-54 Serisi

Papağan Penseler (Düğmeli Tip)



KOD NO	mm "	max. mm		FİYAT/TL
E30Q-54-0180	180 - 7"	42	6	
E30Q-54-0250	250 - 10"	50	6	
E30Q-54-0300	300 - 12"	70	6	

E34-250

Ayarlı Boru Kavrama Pensesi (Plastik Koruma)



KOD NO	mm "	max. mm		FİYAT/TL
E34-250	230 - 9"	65	6	

E34-250R

Yedek Plastik Ağız Takımı (E34-250 için)



KOD NO			FİYAT/TL
E34-250R	Yedek Plastik Ağız Tk.	6	

E36-54 Serisi

Betoncu Kerpetenleri (PVC Daldırma Sap)



Forged in Germany

KOD NO	mm "		FİYAT/TL
E36-54-0225	225 - 9"	6	
E36-54-0250	250 - 10"	6	
E36-54-0280	280 - 11"	6	

Kart Bedeli
Teşhir kartlı sipariş için = Ürün kodu + X**E36-54-0280D**

E36-54-0280 Betoncu Kerpeteni Teşhir Seti - 8 Adet

ÇOK AL
AZ ÖDE

KOD NO		FİYAT/TL
E36-54-0280D	1	



8 x E36-54-0280

E35 Serisi

Marangoz Kerpetenleri



KOD NO	mm "		FİYAT/TL
E35-54-0160	160 - 6"	6	
E35-54-0180	180 - 7"	6	
E35-54-0200	200 - 8"	6	

Kart Bedeli
Teşhir kartlı sipariş için = Ürün kodu + X**E36-56 Serisi**

Betoncu Kerpetenleri (İzolesiz)



Forged in Germany

KOD NO	mm "		FİYAT/TL
E36-56-0225	225 - 9"	6	
E36-56-0250	250 - 10"	6	
E36-56-0280	280 - 11"	6	

Kart Bedeli
Teşhir kartlı sipariş için = Ürün kodu + X**E36-56-0280D**

E36-56-0280 Betoncu Kerpeteni Teşhir Seti - 8 Adet

ÇOK AL
AZ ÖDE

KOD NO		FİYAT/TL
E36-56-0280D	1	



8 x E36-56-0280

6 Penseler ve Kesiciler

E37 Serisi Tepe Kesikler



KOD NO	mm		FİYAT/TL
E37-54-0160	160 - 6"	6	
E37-54-0180	180 - 7"	6	

Kart Bedeli

Teşhir kartlı sipariş için = Ürün kodu + X

E38-54-0200 Kompakt Keski (Çivi, Perçin v.b. İçin)



KOD NO	mm	Ø mm	FİYAT/TL
E38-54-0200	200 - 8"	70	6

E50-R03 3 Parça Üniversal Ayarlı Pense Takımı (Deri Çantalı)



KOD NO	FİYAT/TL
E50-R03	1



E50-140-2 E50-190-2 E50-240-2

E50-2 Serisi Üniversal Ayarlı Penseler



KOD NO	mm	max mm	FİYAT/TL
E50-140-2	140	0-32	1
E50-190-2	190	0-42	1
E50-240-2	240	0-62	1
E50-300-2	300	0-75	1

E51-2 Serisi Düz Ağızlı Ayarlı Penseler



KOD NO	mm	max mm	FİYAT/TL
E51-190-2	190	0-42	1
E51-240-2	240	0-63	1

E52-240-2 Özel Ağızlı Ayarlı Pense



KOD NO	mm	max mm	FİYAT/TL
E52-240-2	240	0-62	1

E52S-240-2 Özel Ağızlı Ayarlı Pense



KOD NO	mm	max mm	FİYAT/TL
E52S-240-2	240	0-67	1

E50L-2 Serisi Uzun Burunlu Ayarlı Penseler



KOD NO	mm	KAPASİTE Max mm	FİYAT/TL
E50L-170-2	170	0-50	1
E50L-230-2	230	0-68	1

E53-280-2 Kaynakçı Ayarlı Pensesi (U Ağız)



KOD NO	mm	max mm	FİYAT/TL
E53-280-2	290	0-90	1

E54-200-2 Kaynakçı Ayarlı Pensesi (Yassı Ağız)



KOD NO	mm	KAPASİTE Max mm	FİYAT/TL
E54-200-2	200	0-55	1

E55-2 Serisi "C" Tipi Ayarlı Penseler



KOD NO	mm	max mm	FİYAT/TL
E55-280-2	288	0-110	1
E55-470-2	470	0-260	1

E55P-2 Serisi

"C" Tipi Ayarlı Penseler (Pabuç Ağız)



KOD NO	mm	Ø max. mm		FİYAT/TL
E55P-180-2	178	0-50	1	
E55P-300-2	300	0-100	1	

E55T-2 Serisi

"C" Tipi Ayarlı Penseler (Masa Tipi)

yeni

KOD NO	mm	h/mm		FİYAT/TL
E55T-390-2	390	0-145	1	
E55T-500-2	500	0-225	1	

E56-L1

Eksenel Ayarlı Pense – L Uçlu



KOD NO	mm	h/mm		FİYAT/TL
E56-L1	195	0-15	1	

E56-L2

Eksenel Ayarlı Pense – LL Uçlu



KOD NO	mm	h/mm		FİYAT/TL
E56-L2	220	0-15	1	

E56-J1

Eksenel Ayarlı Pense – J Uçlu



KOD NO	mm	h/mm		FİYAT/TL
E56-J1	210	0-15	1	

E56-J2

Eksenel Ayarlı Pense – JJ Uçlu



KOD NO	mm	h/mm		FİYAT/TL
E56-J2	235	0-15	1	

E56-W1

Eksenel Ayarlı Pense – W Uçlu



KOD NO	mm	h/mm		FİYAT/TL
E56-W1	195	0-15	1	

E50MIC

Mikro Ayarlı Pense



KOD NO	mm	h/mm		FİYAT/TL
E50MIC	91	0-12.7	1	

E52-16-0240

Özel Ağızlı Ayarlı Pense



KOD NO	mm	Ø max. mm		FİYAT/TL
E52-16-0240	240	0-62	6	

E55-16-0290

"C" Tipi Ayarlı Pense



KOD NO	mm	Ø max. mm		FİYAT/TL
E55-16-0290	290	0-100	1	



CETA FORM
QUALITY

6 Penseler ve Kesiciler

E60-51-0170

RZR Kablo Kesici (DuoTech Sap)

RZR



Forged in Germany

KOD NO	mm "	Ø mm	Box	FİYAT/TL
E60-51-0170	170 - 6-1/2"	15	6	

E60-54-0170

RZR Kablo Kesici (PVC Daldırma Sap)

RZR



Forged in Germany

KOD NO	mm "	Ø mm	Box	FİYAT/TL
E60-54-0170	170 - 6-1/2"	15	6	

E60-41 Serisi

Kablo Kesiciler (DuoTech Sap)



KOD NO	mm "	Ø mm	Box	FİYAT/TL
E60-41-0160	160 - 6"	10	6	
E60-41-0200	200 - 8"	10	6	

E60-44 Serisi

Kablo Kesiciler (PVC Daldırma Sap)



KOD NO	mm "	Ø mm	Box	FİYAT/TL
E60-44-0160	160 - 6"	10	6	
E60-44-0200	200 - 8"	10	6	

E62 Serisi

Cırcırlı Kablo Kesiciler

yeni



KOD NO	mm	Ø mm	Box	FİYAT/TL
E62-32	250	32	1	
E62-52	280	52	1	



E62-32R	Yedek Bıçak	1	
E62-52R	Yedek Bıçak	1	

G40-48-0145

Çok Amaçlı Elektrikli Makası



Paslanmaz Çelik

KOD NO	mm	Box	FİYAT/TL
G40-48-0145	145	10	

E64-54-0200

Çelik Halat Kesici (Dövme Ağız)

yeni



KOD NO	mm	Ø mm	Box	FİYAT/TL
E64-54-0200	200	4	6	

E64-44-0190

Çelik Halat Kesici (Çelik Plaka Ağız)



KOD NO	mm	Ø mm	Box	FİYAT/TL
E64-44-0190	190	4	6	

E70-225-2

Delik Delme Pensesi



KOD NO	Ø mm	mm	Box	FİYAT/TL
E70-225-2	1.5 - 4.1	225	1	

E69F-ES2

Kablo Yüksüğü Sıkma Pensesi (Dövme)

yeni
tasarım



KOD NO	mm ²	mm	Box	FİYAT/TL
E69F-ES2	0.50 - 16.0	215	6	

E69F-SL

Scotchlok Konnektör Sıkma Pensesi



KOD NO	KAPASİTE Ø mm	mm	Box	FİYAT/TL
E69F-SL	0.4 - 1.1	150	6	

E69-YT1

İzoleli Kablo Pabucu Sıkma Pensesi



KOD NO	mm ²	mm		FİYAT/TL
E69-YT1	0.5 - 6.0	220	10	

E69-NT1

İzolesiz Kablo Pabucu Sıkma Pensesi



KOD NO	mm ²	AWG		FİYAT/TL
E69-NT1	0.5 - 10.0	220	10	

E69-ES1

Kablo Yüksüğü Sıkma Pensesi



KOD NO	mm ²	AWG		FİYAT/TL
E69-ES1	0.5 - 6.0	220	10	

E69-ESSQ

Kablo Yüksüğü Sıkma Pensesi (Kare Form)



KOD NO	mm ²	AWG		FİYAT/TL
E69-ESSQ	0.25 - 6	23-10	6	

E69-ESSQ/2

Kablo Yüksüğü Sıkma Pensesi (Kare Form-Basınç Ayarı)



KOD NO	mm ²	AWG	mm		FİYAT/TL
E69-ESSQ/2	0.08 - 16	28-5	180	6	

E69-T046

Jak Sıkma Pensesi (Telefon/Data) - 6P-8P



KOD NO		mm		FİYAT/TL
E69-T046	6-8 pin	190	10	

E69-T468

Jak Sıkma Pensesi (Telefon/Data) - 4P-6P-8P



KOD NO		mm		FİYAT/TL
E69-T468	4-6-8 pin	190	10	

E69Q-P04

4 Parça Kablo Pabucu Sıkma Takımı

Bir kit içinde 4 adet değiştirilebilir sıkma çenesi ve yüksek kaliteli bir mandallı sıkma aleti. Ek bir alete ihtiyaç duymadan sıkma kalıplarının hızlı ve zahmetsizce değiştirilmesi.



yeni

	UYGULAMALAR	KAPASİTE (mm ²)	AWG
OB2	Yalıtılmamış açık fiş tipi konektörler	0.5 - 6	20 - 10
YT1	Yalıtılmış terminaller, fiş konektörler ve alın konektörler	0.5 - 6	20 - 10
ES1	Yalıtımlı ve yalıtımsız ve manşonlar (dişliler)	0.5 - 10	20 - 7
NT1	Yalıtılmamış crim terminaller, boru ve sıkıştırılmalı kablo pabuçları	0.5 - 10	20 - 7

KOD NO		FİYAT/TL
E69Q-P04	1	

6 Penseler ve Kesiciler

E80 Serisi

Tel Bükme Penseleri (Cırcırlı)



KOD NO	Ø max. mm	mm	mm	FİYAT/TL
E80-230R	0.5 - 1.6	230	1	
E80-280R	0.5 - 1.6	280	1	

E80-230

Tel Bükme Pensesi



KOD NO	Ø mm	mm	mm	FİYAT/TL
E80-230	0.5 - 1.6	230	1	

E81-180

Somun Pensesi



KOD NO	mm "	mm	FİYAT/TL
E81-180	180 - 7"	6	

E82-190

Cleco Pensesi



KOD NO	mm	mm	FİYAT/TL
E82-190	190	6	

E65 Serisi

Dış Segman Penseleri (Düz Uçlu-Yaylı)



KOD NO	mm	mm	mm	FİYAT/TL
E65-44-0140	140	10 - 25 / A1	6	
E65-44-0180	180	19 - 60 / A2	6	
E65-44-0225	225	40 - 100 / A3	6	
E65-44-0310	310	85 - 140 / A4	6	

E66 Serisi

Dış Segman Penseleri (Eğri Uçlu-Yaylı)



KOD NO	mm	mm	mm	FİYAT/TL
E66-44-0140	140	10 - 25 / A1B	6	
E66-44-0180	180	19 - 60 / A2B	6	
E66-44-0225	225	40 - 100 / A3B	6	
E66-44-0310	310	85 - 140 / A4B	6	

E99-CP04A

4 Parça Segman Pense Takımı (Deri Çantalı)



KOD NO	FİYAT/TL
E99-CP04A	1



E65-44-0180



E66-44-0180



E67-44-0180



E68-44-0180

E67 Serisi

İç Segman Penseleri (Düz Uçlu-Yaysız)



KOD NO	mm	mm	mm	FİYAT/TL
E67-44-0140	140	12 - 25 / J1	6	
E67-44-0180	180	19 - 60 / J2	6	
E67-44-0225	225	40 - 100 / J3	6	
E67-44-0310	310	85 - 140 / J4	6	

E68 Serisi

İç Segman Penseleri (Eğri Uçlu-Yaysız)



KOD NO	mm	mm	mm	FİYAT/TL
E68-44-0140	140	12 - 25 / J1B	6	
E68-44-0180	180	19 - 60 / J2B	6	
E68-44-0225	225	40 - 100 / J3B	6	
E68-44-0310	310	85 - 140 / J4B	6	

E99-CP04A/2

4 Parça Segman Pense Takımı (Deri Çantalı)



KOD NO	FİYAT/TL
E99-CP04A/2	1



E65-44-0140



E66-44-0140



E67-44-0140



E68-44-0140

yeni

7 1000V İzoleli Aletler ve Multimetreler

109 | 119



G01 Serisi

C-PLUS 1000V Düz Uçlu Tornavidalar (VDE)



1000 V
EN 60900

KOD NO	Ømm	mm	FİYAT/TL
G01-025-075	2.5	75	12
G01-030-100	3.0	100	12
G01-035-100	3.5	100	12
G01-040-100	4.0	100	12
G01-045-125	4.5	125	12
G01-055-125	5.5	125	12
G01-065-150	6.5	150	12
G01-080-175	8.0	175	12

G02 Serisi

C-PLUS 1000V Yıldız Uçlu Tornavidalar (VDE)



1000 V
EN 60900

KOD NO	+	mm	FİYAT/TL
G02-000-060	PH0	60	12
G02-001-080	PH1	80	12
G02-002-100	PH2	100	12
G02-002-150	PH2	150	12
G02-003-150	PH3	150	12

G03 Serisi

C-PLUS 1000V Pozitridriv Uçlu Tornavidalar (VDE)



1000 V
EN 60900

KOD NO	+	mm	FİYAT/TL
G03-000-060	PZ0	60	12
G03-001-080	PZ1	80	12
G03-002-100	PZ2	100	12
G03-002-150	PZ2	150	12
G03-003-150	PZ3	150	12

G04 Serisi

C-PLUS 1000V TORX Uçlu Tornavidalar (VDE)

yeni



1000 V
EN 60900

KOD NO	T	mm	FİYAT/TL
G04-010-100	T10	100	12
G04-015-100	T15	100	12
G04-020-100	T20	100	12
G04-025-125	T25	125	12
G04-027-150	T27	150	12
G04-030-150	T30	150	12

G05 Serisi

C-PLUS 1000V Terminal Tornavidaları (VDE)



1000 V
EN 60900

KOD NO	+	mm	FİYAT/TL
G05-001-080	#1	80	12
G05-002-100	#2	100	12

G06 Serisi

C-PLUS 1000V Allen Uçlu Tornavidalar



1000 V
EN 60900

KOD NO	Ømm	mm	FİYAT/TL
G06-030-080	3	80	12
G06-040-080	4	80	12
G06-050-080	5	80	12
G06-060-100	6	100	12

G07 Serisi

C-PLUS 1000V Lokma Uçlu Tornavidalar (VDE)



1000 V
EN 60900

KOD NO	Ømm	mm	FİYAT/TL
G07-050-125	5	125	12
G07-055-125	5.5	125	12
G07-060-125	6	125	12
G07-070-125	7	125	12
G07-080-125	8	125	12
G07-090-125	9	125	12
G07-100-125	10	125	12
G07-110-125	11	125	12
G07-120-125	12	125	12
G07-130-125	13	125	12

G26/BT

C-PLUS 1000V Bits Tutucu Tornavida (VDE)



1000 V
EN 60900

KOD NO	Ømm	mm	FİYAT/TL
G26/BT	1/4	100	12



7 1000V İzoleli Aletler ve Multimetreler

G05-B02

2 Parça C-PLUS 1000V Terminal Tornavida Takımı (VDE)



x2



KOD NO	FİYAT/TL
G05-B02	1

G05 #1x80, #2x100 mm

G99-401

4 Parça C-PLUS 1000V Tornavida Takımı (VDE) - Düz/Yıldız



x3

x1



KOD NO	FİYAT/TL
G99-401	1

G01 2.5x75, 4.0x100, 5.5x125 mm
G02 PH2x100 mm

G99-402

4 Parça C-PLUS 1000V Tornavida Takımı (VDE) - Düz/Pozitridr



x3

x1

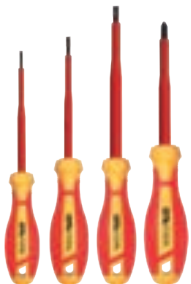

KOD NO	FİYAT/TL
G99-402	1

G01 2.5x75, 4.0x100, 5.5x125 mm
G03 PZ2x100 mm

G07-B05

5 Parça C-PLUS 1000V Lokma Uçlu Tornavida Takımı (VDE)



x5



KOD NO	FİYAT/TL
G07-B05	1

G07 6.0x125, 7.0x125, 8.0x125, 10x125 mm, 13x125 mm

G99-701

7 Parça C-PLUS 1000V Tornavida Takımı (VDE) - Düz/Yıldız + Kontrol Kalemi



x5

x2

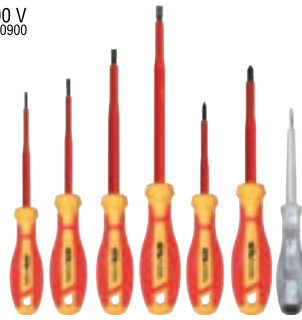

KOD NO	FİYAT/TL
G99-701	1

G01 3.0x100, 4.0x100, 5.5x125, 6.5x150 mm
G02 PH1x80, PH2x100 mm
6105CP Kontrol Kalemi (Kısa)

G99-702

7 Parça C-PLUS 1000V Tornavida Takımı (VDE) - Düz/Pozitridr + Kontrol Kalemi



x5

x2

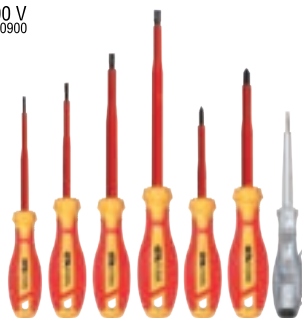

KOD NO	FİYAT/TL
G99-702	1

G01 3.0x100, 4.0x100, 5.5x125, 6.5x150 mm
G03 PZ1x80, PZ2x100 mm
6105CP Kontrol Kalemi (Kısa)

G99-901

9 Parça C-PLUS 1000V Tornavida Takımı (VDE-Deri Çantalı)



x5

x2

x2



KOD NO	FİYAT/TL
G99-901	1

G01 3.0x100, 4.0x100, 5.5x125, 6.5x150 mm
G02 PH1x80, PH2x100 mm
G03 PZ1x80, PZ2x100 mm
6105CP Kontrol Kalemi (Kısa)

SG99 Serisi

C-PLUS 1000V Tornavida Takımı Teşhir Setleri (VDE)



KOD NO	FİYAT/TL
SG99-701	1

12x G99-701
SG99-702
12x G99-702

G01S Serisi

C-PLUS 1000V Düz Uçlu Tornavidalar (Slimline)



KOD NO	Ø mm	mm	FİYAT/TL
G01S-035-100	3.5	100	12
G01S-040-100	4.0	100	12
G01S-055-125	5.5	125	12
G01S-065-150	6.5	150	12

G02S Serisi

C-PLUS 1000V Yıldız Uçlu Tornavidalar (Slimline)



KOD NO	+	mm	FİYAT/TL
G02S-001-080	PH1	80	12
G02S-002-100	PH2	100	12

G03S Serisi

C-PLUS 1000V Pozidriv Uçlu Tornavidalar (Slimline)



KOD NO	+	mm	FİYAT/TL
G03S-001-080	PZ1	80	12
G03S-002-100	PZ2	100	12

G05S-002-100

C-PLUS 1000V Terminal Tornavidaları (Slimline)



KOD NO	+	mm	FİYAT/TL
G05S-002-100	#2	100	12

GRT-M Serisi

Vida Yuvası Yenileme Kılavuzları (Elektrik Prizleri için)



KOD NO	M ÖLÇÜ	mm	FİYAT/TL
GRT-M35	M3.5x0.6	118	12
GRT-M40	M4.0x0.7	118	12

G99-701S

7 Parça C-PLUS 1000V Tornavida Tk. (Slimline) - Düz / Yıldız+Kontrol Kalemi

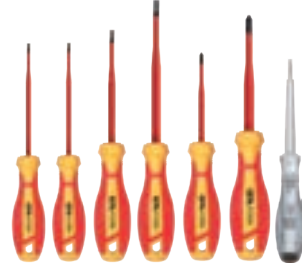

KOD NO	FİYAT/TL
G99-701S	1

- G01S 3.5x100, 4.0x100, 5.5x125, 6.5x150 mm
- G02S PH1x80, PH2x100 mm
- 6105CP Kontrol Kalemi (Kısa)

G99-702S

7 Parça C-PLUS 1000V Tornavida Tk. (Slimline) - Düz/Pozidriv+Kontrol Kalemi

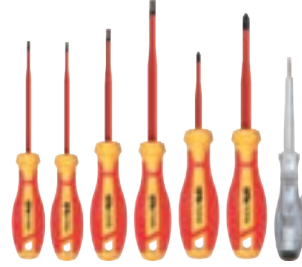

KOD NO	FİYAT/TL
G99-702S	1

- G01S 3.5x100, 4.0x100, 5.5x125, 6.5x150 mm
- G03S PZ1x80, PZ2x100 mm
- 6105CP Kontrol Kalemi (Kısa)

G09-NC1

Temassız AC Kontrol Kalemi



KOD NO	mm	mm	FİYAT/TL
G09-NC1	4.5	152	20

yeni
içerik**6105CP**

C-PLUS Kontrol Kalemi (VDE-Küçük)



KOD NO	Ø mm	mm	FİYAT/TL
6105CP	3.0	140	24 •

Kart Bedeli
Teşhir kartlı sipariş için = Ürün Kodu + X 12

6106CP

C-PLUS Kontrol Kalemi (VDE-Büyük)



KOD NO	Ø mm	mm	FİYAT/TL
6106CP	3.5	170	24 •

Kart Bedeli
Teşhir kartlı sipariş için = Ürün Kodu + X 12

6105

Kontrol Kalemi (Küçük)



KOD NO	Ø mm	mm	FİYAT/TL
6105	3.0	140	24 •

6106

Kontrol Kalemi (Büyük)



KOD NO	Ø mm	mm	FİYAT/TL
6106	3.5	180	24 •

6106EX

Kontrol Kalemi (Büyük)



KOD NO	Ø mm	mm	FİYAT/TL
6106EX	4.0	187	24 •

7 1000V İzoleli Aletler ve Multimetreler

G10 Serisi

1000V Kombine Penseler (VDE)



Forged in Germany



KOD NO	mm "	Ø mm		FİYAT/TL
G10-18-0160	160 - 6"	1.8	6	
G10-18-0180	180 - 7"	2.0	6	
G10-18-0200	200 - 8"	2.5	6	

G10H Serisi

1000V Power Kombine Penseler (VDE)



Forged in Germany



KOD NO	mm "	Ø mm		FİYAT/TL
G10H-18-0180	180 - 7"	2.0	6	
G10H-18-0200	200 - 8"	2.5	6	

G20-MMAX

1000V Çok Amaçlı Elektrikçi Pensesi

Yeni tasarım

7 FONKSİYON
TEK ALETTE



Forged in Germany



Kablo Sıyırma Kapasitesi	: 0.75, 1.0, 1.5, 2.5 mm ²
Civata Kesme Kapasitesi	: M3.5, M4
İzolesiz Kablo Pabucu Sıkma Kapasitesi	: 0.75, 1.0, 1.5, 2.5, 4.0 mm ²
İzolesiz Kablo Yüksüğü Sıkma Kapasitesi	: 0.50, 0.75, 1.0, 1.5, 2.5 mm ²
Kablo Kesme Kapasitesi	: Ø15 mm / 50 mm ²
Yassı ve Yuvarlak malzemeleri tutma, kablo bükme	

KOD NO	mm "		FİYAT/TL
G20-MMAX	225 - 9"	6	

G12 Serisi

1000V Yan Kesimler (VDE)



Forged in Germany



KOD NO	mm "	Ø mm		FİYAT/TL
G12-18-0140	140 - 5-1/2"	1.8	6	
G12-18-0160*	160 - 6"	2.0	6	
G12-18-0180	180 - 7"	2.5	6	

* Yüksek kaldıraçlı tasarım

G14 Serisi

1000V Power Yan Kesimler (VDE)



Forged in Germany



piano plus

KOD NO	mm "	Ø mm		FİYAT/TL
G14-18-0180	180 - 7"	2.0	6	
G14-18-0200	200 - 8"	2.2	6	

SG18-24

24 Parça 1000V Pense Teşhir Paketi (VDE)

ÇOK AL
AZ ÖDE



KOD NO		FİYAT/TL
SG18-24	1	



12x G10-18-0180



12x G12-18-0160

G99-18-02A

2 Parça 1000V Pense Takımı (VDE)

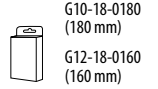

KOD NO		FİYAT/TL
G99-18-02A	1	

G99-18-03A

3 Parça 1000V Pense Takımı (VDE)

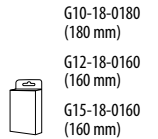

KOD NO		FİYAT/TL
G99-18-03A	1	

G99-18-05 Serisi

5 Parça 1000V Pense-Tornavida Setleri (VDE)



KOD NO		FİYAT/TL
G99-18-05PH	1	



G10-18-0180

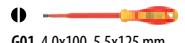

G01 4.0x100, 5.5x125 mm



G12-18-0160



G02 PH2x100 mm

G99-18-05PZ	1	
-------------	---	--

İçerik: G99-18-05PH ile aynı fakat Yıldız yerine Pozidriv tornavida içermektedir.

G15 Serisi

1000V Kargaburunlar (VDE)



Forged in Germany



KOD NO	mm "	Ø mm	6	FİYAT/TL
G15-18-0160	160 - 6"	1.6	6	
G15-18-0200	200 - 8"	1.6	6	

G18-18-0160

1000V Yuvarlak Kargaburun (VDE)



Forged in Germany



KOD NO	mm "	6	FİYAT/TL
G18-18-0160	160 - 6"	6	

G25-58-0250

1000V Papağan Pense (VDE)



Forged in Germany



KOD NO	mm "	Ø max mm	6	FİYAT/TL
G25-58-0250	250 - 10"	28	6	

G16 Serisi

1000V Eğri Kargaburunlar (VDE)



Forged in Germany



KOD NO	mm "	Ø mm	6	FİYAT/TL
G16-18-0160	160 - 6"	1.6	6	
G16-18-0200	200 - 8"	1.6	6	

G20-18-0160

1000V Kablo Sıyırma Pensesi (VDE)



Forged in Germany



KOD NO	mm "	mm ²	6	FİYAT/TL
G20-18-0160	160 - 6"	10	6	

G30-48 Serisi

1000V Kablo Kesiciler (VDE)



KOD NO	mm "	Ø mm	6	FİYAT/TL
G30-48-0160	160 - 6"	10	6	
G30-48-0200	200 - 8"	18	6	

G17-18-0160

1000V Yassı Kargaburun (VDE)



KOD NO	mm "	6	FİYAT/TL
G17-18-0160	160 - 6"	6	

G21-18-0160

1000V Kablo Sıyırıcı Yan Keski (VDE)



Forged in Germany



KOD NO	mm "	mm ²	6	FİYAT/TL
G21-18-0160	160 - 6"	1.5, 2.5	6	

G30-58-0170

1000V RZR Kablo Kesici (VDE)



Forged in Germany



KOD NO	mm "	Ø max mm	6	FİYAT/TL
G30-58-0170	170 - 6-1/2"	15	6	

RZR

7 1000V İzoleli Aletler ve Multimetreler

GB09 Serisi 1000V Çatal Ağız Anahtarlar

yeni



1000 V
EN 60900

KOD NO	Ømm	mm	FİYAT/TL
GB09-05/2	5.5	93	12
GB09-06	6	93	12
GB09-07	7	97	12
GB09-08	8	99	12
GB09-09	9	103	12
GB09-10	10	113	12
GB09-11	11	123	12
GB09-12	12	133	12
GB09-13	13	143	12
GB09-14	14	155	12
GB09-15	15	158	12
GB09-16	16	163	12
GB09-17	17	173	12
GB09-18	18	180	12
GB09-19	19	188	12
GB09-22	22	203	12
GB09-24	24	228	6

GB14 Serisi 1000V Yıldız Ağız Anahtarlar

yeni



1000 V
EN 60900

KOD NO	Ømm	mm	FİYAT/TL
GB14-10	10	170	12
GB14-11	11	175	12
GB14-12	12	180	12
GB14-13	13	185	12
GB14-14	14	190	12
GB14-15	15	195	12
GB14-16	16	200	12
GB14-17	17	205	12
GB14-18	18	210	6
GB14-19	19	215	6
GB14-22	22	245	6
GB14-24	24	265	6

GC12-H Serisi 3/8" 1000V 6 Köşe Lokma Anahtarlar

yeni



1000 V
EN 60900

10
3/8"

KOD NO	Ømm	mm	FİYAT/TL
GC12-H06	6	48	12
GC12-H07	7	48	12
GC12-H08	8	48	12
GC12-H09	9	48	12
GC12-H10	10	48	12
GC12-H11	11	48	12
GC12-H12	12	48	12
GC12-H13	13	48	12
GC12-H14	14	48	12
GC12-H15	15	48	12
GC12-H16	16	48	12
GC12-H17	17	50	12
GC12-H18	18	50	12
GC12-H19	19	50	12
GC12-H20	20	50	12
GC12-H21	21	50	12
GC12-H22	22	52	12

GB09-R06 6 Parça 1000V Çatal Ağız Anahtar Takımı (Bez Çantalı)

yeni



KOD NO	FİYAT/TL
GB09-R06	1

6 PC: 10, 12, 13, 14, 17, 19 mm

GB14-R06 6 Parça 1000V Yıldız Ağız Anahtar Takımı (Bez Çantalı)

yeni



KOD NO	FİYAT/TL
GB14-R06	1

6 PC: 10, 12, 13, 14, 17, 19 mm

GC18S-H Serisi 3/8" 1000V Allen Uçlu Lokmalar

yeni



1000 V
EN 60900

10
3/8"

KOD NO	Ømm	mm	FİYAT/TL
GC18S-H04	4	60	12
GC18S-H05	5	60	12
GC18S-H06	6	60	12
GC18S-H08	8	60	12

GB21-250 1000V Kurbağacık Anahtar

yeni



1000 V
EN 60900

KOD NO	mm	Ømm	FİYAT/TL
GB21-250	250 - 10"	30	6

GK10 Serisi 1000V T Saplı Allen Anahtarlar

yeni



1000 V
EN 60900

KOD NO	Ømm	mm	FİYAT/TL
GK10-030	3	100	12
GK10-040	4	150	12
GK10-050	5	150	12
GK10-060	6	200	12
GK10-080	8	200	12

GC18S-T Serisi 3/8" 1000V TORX Uçlu Lokmalar

yeni



1000 V
EN 60900

10
3/8"

KOD NO	Ømm	mm	FİYAT/TL
GC18S-T20	T20	60	12
GC18S-T25	T25	60	12
GC18S-T27	T27	60	12
GC18S-T30	T30	60	12
GC18S-T40	T40	60	12
GC18S-T45	T45	60	12

GC18S-X Serisi

3/8" 1000V XZN Uçlu Lokmalar

yeni

10
3/8"

KOD NO	mm	mm	FİYAT/TL
GC18S-X08	M08	60	12
GC18S-X10	M10	60	12

GC11-12

3/8" 1000V Düğmeli Cırcır Kolu

yeni

10
3/8"

KOD NO	mm	mm	FİYAT/TL
GC11-12	43	200	6

GC11-40

3/8" 1000V T Kolu

yeni

10
3/8"

KOD NO	mm	FİYAT/TL
GC11-40	210	6

GC11-70 Serisi

3/8" 1000V Uzatma Kolları

yeni

10
3/8"

KOD NO	mm	FİYAT/TL
GC11-72	93	12
GC11-75	170	12

GC10-19PH2

19 Parça 3/8" 1000V 6 Köşe Lokma Takımı

yeni

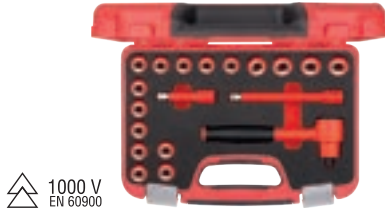
10
3/8"

KOD NO	FİYAT/TL
GC10-19PH2	1



GC12-H 6, 7, 8, 9, 10, 11, 12, 13, 14, 15, 16, 17, 18, 19, 20, 22 mm

GC11-12

GC11-70 93, 170 mm

GC22-H Serisi

1/2" 1000V 6 Köşe Lokma Anahtarlar

yeni

12.5
1/2"

KOD NO	mm	mm	FİYAT/TL
GC22-H10	10	55	12
GC22-H11	11	55	12
GC22-H12	12	55	12
GC22-H13	13	55	12
GC22-H14	14	55	12
GC22-H15	15	55	12
GC22-H16	16	55	12
GC22-H17	17	55	12
GC22-H18	18	55	12
GC22-H19	19	55	12
GC22-H20	20	55	12
GC22-H21	21	55	12
GC22-H22	22	55	12
GC22-H24	24	58	6
GC22-H27	27	60	6
GC22-H30	30	61	6
GC22-H32	32	62	6

GC28S-HL Serisi

1/2" 1000V Allen Uçlu Lokmalar - Uzun

yeni

12.5
1/2"

KOD NO	mm	mm	FİYAT/TL
GC28S-H04L	4	120	12
GC28S-H05L	5	120	12
GC28S-H06L	6	120	12
GC28S-H08L	8	120	12
GC28S-H10L	10	120	12

GC21-12

1/2" 1000V Düğmeli Cırcır Kolu

yeni

12.5
1/2"

KOD NO	mm	mm	FİYAT/TL
GC21-12	47.5	234	6

GC21-40

1/2" 1000V T Kolu

yeni

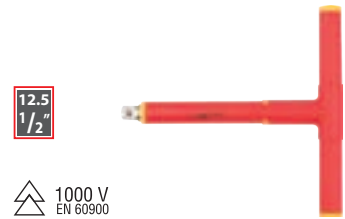
12.5
1/2"

KOD NO	mm	FİYAT/TL
GC21-40	205	12

GC21-70 Serisi

1/2" 1000V Uzatma Kolları

yeni

12.5
1/2"

KOD NO	mm	FİYAT/TL
GC21-74	140	12
GC21-77	270	12

7 1000V İzoleli Aletler ve Multimetreler

GC20-19PH2

19 Parça 1/2" 1000V 6 Köşe Lokma Takımı

yeni



1000 V
EN 60900

12.5
1/2"

KOD NO	FİYAT/TL
GC20-19PH2	1



GC22-H 10, 11, 12, 13, 14, 15, 16,
17, 18, 19, 20, 22, 24, 27, 30, 32 mm



GC21-12



GC21-70 140 mm, 270 mm

GD02 Serisi

1000V Tork Anahtarları

yeni



1000 V
EN 60900

±4 %

10
3/8"

12.5
1/2"

KOD NO	N-m	mm	mm	FİYAT/TL
GD02-1125	5 - 25	3/8	404	1
GD02-1105	10 - 50	3/8	467	1
GD02-2110	20 - 100	1/2	467	1

GJ36-150

1000V Mini Testere Kolu

yeni

EN 60900, VDE 0682 Teil 201



1000 V
EN 60900

KOD NO	mm	FİYAT/TL
GJ36-150	280	12

E75-081

Kontrol Kabini Anahtarı - 8 Ağız

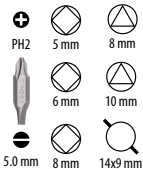

KOD NO	mm	FİYAT/TL
E75-081	71	12

G99-BP04

4 Parça 1000V Pense-Tornavida Seti (VDE-Bel Çantalı)

yeni



KOD NO	2023	FİYAT/TL
G99-BP04	1	



G12-18-0160



G01 4x100 mm



6105CP Kontrol Kalem (Kısa)



G02 PH2x100 mm

G99-BP06

6 Parça 1000V Pense-Tornavida Seti (VDE-Bel Çantalı)

yeni



KOD NO	2023	FİYAT/TL
G99-BP06	1	



G10-18-0180



G01 4x100, 5.5x125 mm



G02 PH2x100 mm



G12-18-0160



6105CP Kontrol Kalem (Kısa)

G99-18-W09 Serisi

9 Parça 1000V Pense-Tornavida Setleri (VDE-Deri Çantalı)



KOD NO	2023	FİYAT/TL
G99-18-W09PH	1	



G10-18-0180



G01 2.5x75, 4x100, 5.5x125 mm

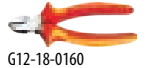

G12-18-0160

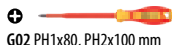

G02 PH1x80, PH2x100 mm



G15-18-0160



6105CP Kontrol Kalem (Kısa)

KOD NO	FİYAT/TL
G99-18-W09PZ	1

İçerik: G99-18-W09PH ile aynı fakat Yıldız yerine Pozidriv tornavidalar içermektedir.

G99-18-W12 Serisi

12 Parça 1000V Pense-Tornavida Setleri (VDE-Deri Çantalı)

yeni
içerik



KOD NO	2023	FİYAT/TL
G99-18-W12PH	1	



G10-18-0180



G01 2.5x75, 4x100, 5.5x125 mm

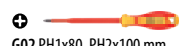

G02 PH1x80, PH2x100 mm



G12-18-0160



6105CP Kontrol Kalem (Kısa)



G15-18-0160



E25-CK28H



G30-48-0160



P05-0316 3mx16mm

KOD NO	FİYAT/TL
G99-18-W12PZ	1

İçerik: G99-18-W12P ile aynı fakat Yıldız yerine Pozidriv tornavidalar içermektedir.

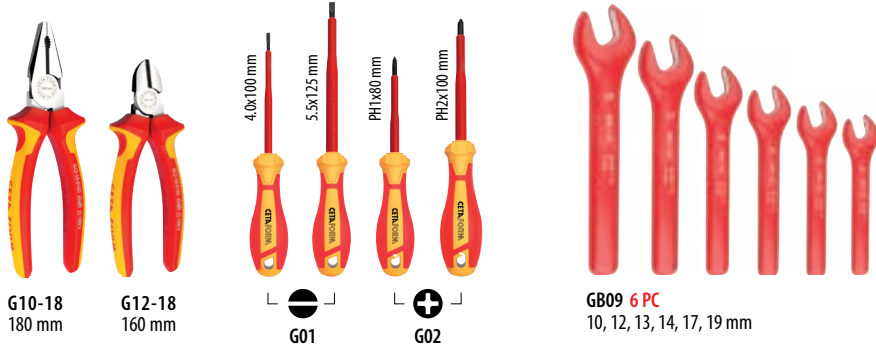
G99-P26**26 Parça Elektrikçi Alet Seti****Yeni****1000 V**
EN 60900**G10-18**
180 mm**G12-18**
160 mm**G01****G02****GB09 6 PC**
10, 12, 13, 14, 17, 19 mm**G12-H 10 PC**
8, 10, 12, 13, 14, 15, 16, 17, 19, 22 mm**G11-12** **G11-70 2 PC**
93 mm, 170 mm**G50-P1**
215 mm

KOD NO	PARÇA	GxYxD / mm	FİYAT/TL
G99-P26	26	440x320x100	

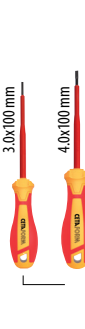
G99-0431**31 Parça Elektrikçi Alet Seti****Yeni**
içerik**1000 V**
EN 60900**G10-18**
180 mm**G12-18**
160 mm**G15-18**
160 mm**G30-58**
170 mm**G01****G02****6105CP****G09-NC1****J36**
150 mm**L01 500 gr****L25-200-2**
24x200 mm**E75-081****P05-519**
5m x 19 mm**F26/RDS**
12 in 1**E25-CK28H****E25-AS06****31 Parça Alet Seti****31 Parça Elektrikçi Alet Setleri (Takım Çantaları ile)**

Sadece içerik

(G99-0431+A26-TB19)

(G99-0431+A27-19PL)

(G99-0431+A32)

(G99-0431+A32H)

**KOD NO** **G99-0431****G99-0431A26****G99-0431A27****G99-0431A32****G99-0431A32H****FİYAT/TL**

7 1000V İzoleli Aletler ve Multimetreler

G80-AAC1

Dijital Multimetre (AC/DC Akım-Otomatik Sınıflama)



TRUE
RMS



KOD NO	1	FİYAT/TL
G80-AAC1	1	

NCV fonksiyonu, MAX/MIN modu, veri tutma, aydınlatmalı ekran, REL modu, frekans/görev döngüsü, otomatik kapanma ve sesli alarm, anti yüksek voltaj devre tasarımı, 1000V CATII, büyük LCD ekran, 2xAAA pil

FONKSİYON	KADEME	DOĞRULUK
DC Voltaj	400mV/4V/40V/400V/1000V	±(0.5%+5)
AC Voltaj	400mV/4V/40V/400V/750V	±(0.8%+10)
DC Akım	400uA/4000uA/40mA/400mA/4A/20A	±(1.0%+5)
AC Akım	400uA/4000uA/40mA/400mA/4A/20A	±(1.5%+10)
Direnç	400Ω/4kΩ/40kΩ/400kΩ/4MΩ/40MΩ	±(0.8%+2)
Kapasitans	4nF/40nF/400nF/4uF/40uF/200uF	
	40nF/400nF/4uF/40uF/400uF/4mF/40mF	±(2.5%+5)
Frekans	10Hz/100Hz/1kHz/10kHz/100kHz/1MHz	±(0.5%+4)
Sıcaklık	-40°C~1000°C	±(1.0%+5)
	-OFF ~1832°F	±(1.0%+5)

G80-AAC2

Smart Dijital Multimetre



TRUE
RMS

yeni

TEK TUŞLA KULLANIM

KOD NO	1	FİYAT/TL
G80-AAC2	1	

Otomatik sınıflama, Otomatik olarak aralık, AVO testleri için kayma yok, LCD ekran, NCV, Gerçek RMS testleri, Veri tutma ve arka ışık işlevi, Analog çubuk ekranı, 3V AAAx2 pil ile çalışır

FONKSİYON	KADEME	DOĞRULUK
DC Voltaj	6V/60V/600V	±(0.5%+5)
AC Voltaj	6V/60V/600V	±(0.8%+10)
AC Akım	10A	±(1.5%+10)
Direnç	600Ω/6kΩ/60kΩ/600kΩ/6MΩ/60MΩ	±(0.8%+2)
AC Frekans	Akım 10Hz-1000Hz/ voltage 10kHz-100kHz, 1mHz-10mHz	±(0.5%+4)
Sıcaklık	-40°C~1000°C	±(1.0%+5)
	-OFF ~1832°F	±(1.0%+5)

G80-MDC2

Dijital Multimetre (DC Akım-Manuel Sınıflandırma)



yeni

KOD NO	1	FİYAT/TL
G80-MDC2	1	

Manuel aralıklandırma, Voltaj (AC/DC), akım (DC), direnç, diyot fonksiyonları, LCD ekran, NCV, True RMS testleri, Veri tutma fonksiyonu, 3V AAAx2 pil ile çalışır

FONKSİYON	KADEME	DOĞRULUK
DC Voltaj	200mV/2V/20V/200V/600V	±(0.5%+4)
AC Voltaj	200V/600V	±(1.0%+6)
DCA Akım	20uA//2mA//200mA/10A	±(1.0%+5)
Direnç	200Ω/2kΩ/20kΩ/2MΩ/200MΩ	±(0.8%+1)

G85-ADC1

Dijital Pens Ampermetre
(AC/DC Akım-Otomatik Sınıflama)

**TRUE
RMS**

KOD NO	Pens Aralığı max. mm		FİYAT/TL
G85-ADC1	52	1	
FONKSİYON	KADEME		DOĞRULUK
DC Voltaj	400mV/4V/40V/400V/1000V		±(0.5%+5)
AC Voltaj	4V/40V/400V/750V		±(1.0%+5)
DC Akım	40A/400A/1000A		±(2.0%+5)
AC Akım	40A/400A/1000A		±(2.0%+5)
Direnç	400Ω/4kΩ/40kΩ/400kΩ/4MΩ/40MΩ		±(0.8%+3)
Kapasitans	4nF/40nF/400nF/4μF/40μF/400μF/4mF/40mF		±(3.5%+10)
Frekans	10Hz/100Hz/1kHz/ 10kHz/100kHz/1MHz/10MHz		±(2%+5)
Sıcaklık	-40°C~1000°C / -40°F~1832°F		±(1.0%+5)

MAX/MIN modu, veri tutma, aydınlatmalı kol ve ekran, REL modu, frekans/görev döngüsü, otomatik kapanma ve uyarı fonksiyonları, anti yüksek voltaj devre tasarımı, 600V CATIII, büyük LCD ekran, 2xAAA pil

**G90-IR750**
Infrared Termometre

Arka ışık işlevi, düşük pil göstergesi, veri tutma işlevi, Maks./Min./AVG./DIF. HOLD fonksiyonu, Yüksek/Düşük sıcaklık Alarm fonksiyonu, sıfır ofset ayarı, birim sembol ekranı

yeni



KOD NO		FİYAT/TL
G90-IR750	1	
TEKNİK ÖZELLİKLER		
Ölçüm Aralığı	-20°C ~ 750°C / 4°F ~ 1382°F	
Doğruluk (Sapma)	<-10°C±3°C / <14°F±6°F	
Tepki Süresi	<400°C (<500ms) / >400°C (<300ms)	
Uzaklık /Hedef Oranı	D:S=12:1	
Ekran Çözünürlüğü	0.1°C / 0.2°F	
Otomatik kapanma	Yaklaşık 6 saniye	
Ölçüm Hızı	≤ 0.5 saniye	
Ayarlanabilir ateşleme oranı	0.1 ~ 1	
Led ekran görüntüleme	3 hane	
Güç tüketimi/sarfiyatı	≤50mW	
Pil	9V (6F22 veya muadili)	

G85-AAC1

Dijital Pens Ampermetre
(AC Akım-Otomatik Sınıflama)

**TRUE
RMS**

KOD NO	Pens Aralığı max. mm		FİYAT/TL
G85-AAC1	52	1	
FONKSİYON	KADEME		DOĞRULUK
DC Voltaj	200mV/2V/20V/200V/1000V		±(0.5%+5)
AC Voltaj	2V/20V/200V/750V		±(1.0%+5)
AC Akım	2A/20A/200A/1000A		±(2.0%+5)
Direnç	200Ω/2kΩ/20kΩ/200kΩ/2MΩ/20MΩ		±(0.8%+3)
Sıcaklık	-40°C~1000°C / -40°F~1832°F		±(1.0%+5)

MAX/MIN modu, veri tutma, aydınlatmalı kol ve ekran, REL modu, frekans/görev döngüsü, otomatik kapanma ve uyarı fonksiyonları, anti yüksek voltaj devre tasarımı, 600V CATIII, büyük LCD ekran, 2xAAA pil

**G90-IR550**
Infrared Termometre

Dahili lazer odaklama, aydınlatmalı LCD ekran, veri depolama, maks. / min. / ortalama / DIF veri kaydı, alçak / yüksek sıcaklık alarm fonksiyonu, girilen degerde sıcaklık ölçümü yapıldığında alarm fonksiyonu, sıfırlama fonksiyonu, düşük pil uyarısı, otomatik kapanma, 1x9V pil



KOD NO		FİYAT/TL
G90-IR550	1	
TEKNİK ÖZELLİKLER		
Ölçüm Aralığı	-50°C ~ 550°C / -58°F ~ 1022°F	
Doğruluk (Sapma)	±1.5°C or ±1.5%	
Uzaklık /Hedef Oranı	D:S=12:1	
Otomatik kapanma	Yaklaşık 6 saniye	
Ölçüm Hızı	≤ 0.5 saniye	
Ayarlanabilir ateşleme oranı	0.1 ~ 1	
Led ekran görüntüleme	3 hane	
Güç tüketimi/sarfiyatı	≤50mW	
Pil	9V (6F22 veya muadili)	



CETA FORM
QUALITY

8 Mikro Tornavidalar ve Penseller

120 | 126



H01 Serisi

Düz Uçlu Elektronikçi Tornavidalar



KOD NO	Ømm	mm	FİYAT/TL
H01-12-040	1.2	40	12•
H01-15-040	1.5	40	12•
H01-18-060	1.8	60	12•
H01-20-060	2.0	60	12•
H01-20-100	2.0	100	12•
H01-25-080	2.5	80	12•
H01-25-100	2.5	100	12•
H01-30-080	3.0	80	12•
H01-30-100	3.0	100	12•
H01-30-150	3.0	150	12•
H01-35-080	3.5	80	12•
H01-40-080	4.0	80	12•
H01-40-100	4.0	100	12•
H01-40-150	4.0	150	12•

H02 Serisi

Yıldız Uçlu Elektronikçi Tornavidalar



KOD NO	+	mm	FİYAT/TL
H02-00-060	PH00	60	12•
H02-0-060	PH0	60	12•
H02-1-080	PH1	80	12•

H03 Serisi

Pozitiv Uçlu Elektronikçi Tornavidalar



KOD NO	+	mm	FİYAT/TL
H03-0-060	PZ0	60	12•
H03-1-080	PZ1	80	12•

H04 Serisi

TORX Uçlu Elektronikçi Tornavidalar



KOD NO	T	mm	FİYAT/TL
H04-04-040	T4	40	12•
H04-05-040	T5	40	12•
H04-06-040	T6	40	12•
H04-07-040	T7	40	12•
H04-08-040	T8	40	12•
H04-09-060	T9	60	12•
H04-10-060	T10	60	12•
H04-15-060	T15	60	12•
H04-20-060	T20	60	12•

H05 Serisi

5 Köşe PENTALOBE Uçlu Elektronikçi Tornavidalar



Apple ürünlerinde bulunan vidalar içindir

KOD NO	☆	mm	FİYAT/TL
H05-02-040	P2	40	12•
H05-05-040	P5	40	12•

H06 Serisi

Allen Uçlu Elektronikçi Tornavidalar



KOD NO	mm	"	mm	FİYAT/TL
H06-15-040	1.5	-	40	12•
H06-20-060	2.0	5/64	60	12•
H06-25-080	2.5	-	80	12•
H06-30-080	3.0	-	80	12•
H06A-0050	-	0.05	40	12
H06A-0116	-	1/16	40	12
H06A-0332	-	3/32	80	12
H06A-0764	-	7/64	80	12

H99-12-06

6 Parça Elektronikçi Tornavida Takımı - Düz/Yıldız



KOD NO	FİYAT/TL
H99-12-06	1

- H01 1.5x40, 2.0x60, 2.5x80, 3.0x80 mm
- ⊕ H02 PH00x60, PH0x60 mm



H99-04-06

6 Parça Elektronikçi Tornavida Takımı - TORX

x6



KOD NO	mm	Ø mm	FİYAT/TL
H99-04-06	1		

H04 T5x40, T6x40, T7x40, T8x40, T9x60, T10x60 mm

H99-06-06

6 Parça Elektronikçi Tornavida Takımı - Allen

x6



KOD NO	mm	Ø mm	FİYAT/TL
H99-06-06	1		

H06 1.5x40, 2 (5/64")x60, 2.5x80, 3x80, 3/32"x80, 7/64"x80 mm

H99-JK-05

4-in-1 Değişken Uçlu Saatçi Tornavida Takımı

yeni

x2

x2



KOD NO	mm	Ø mm	FİYAT/TL
H99-JK-05	100	1	

1.4x32, 1.8x32 mm
PH00x32, PH0x32 mm

H99-JK-06

6 Parça Saatçi Tornavida Takımı

x4

x2



KOD NO	mm	Ø mm	FİYAT/TL
H99-JK-06	1		

1.4x85, 2.0x90, 2.4x100, 3.0x110mm
PH0x100, PH1x110 mm

H20S-120SB

Elektronikçi Yan Keski (Açılı Kesim)



KOD NO	mm	Ø mm	FİYAT/TL
H20S-120SB	120	1.0	6

H20S-120FL

Elektronikçi Yan Keski (Sıfır Kesim)



KOD NO	mm	Ø mm	FİYAT/TL
H20S-120FL	120	1.0	6

H20C-118SB

Elektronikçi Yan Keski (Mini Kafa - Açılı Kesim)



KOD NO	mm	Ø mm	FİYAT/TL
H20C-118SB	118	1.0	6

H20T-120SB

Elektronikçi Yan Keski (Konik Kafa-Açılı Kesim)



KOD NO	mm	Ø mm	FİYAT/TL
H20T-120SB	120	1.0	6

H22-130

Elektronikçi Kombine Pense



KOD NO	mm	Ø mm	FİYAT/TL
H22-130	130	1.0	6

H21S-125SB

Elektronikçi Tepe Keski



Paslanmaz Çelik

KOD NO	mm	Ø mm	FİYAT/TL
H21S-125SB	125	1.0	6

H21N-130SB

Elektronikçi Eğri Tepe Keski (Dar Kesici Ağızlı)



Paslanmaz Çelik

KOD NO	mm	Ø mm	FİYAT/TL
H21N-130SB	130	1.0	6

H23S-130

Elektronikçi Kargaburun (Dişli Tutma Yüzeyi)



Paslanmaz Çelik

KOD NO	mm	Ø mm	FİYAT/TL
H23S-130	130	6	

8 Mikro Tornavidalar ve Penseler

H23F-130

Elektronikçi Kargaburun (Düz Tutma Yüzeyi)



Paslanmaz Çelik

KOD NO	mm		FİYAT/TL
H23F-130	130	6	

H24-130

Elektronikçi Eğri Kargaburun



Paslanmaz Çelik

KOD NO	mm		FİYAT/TL
H24-130	130	6	

H25-155

Elektronikçi İğne Kargaburun



Paslanmaz Çelik

KOD NO	mm		FİYAT/TL
H25-155	155	6	

H26-130

Elektronikçi Yuvarlak Kargaburun



Paslanmaz Çelik

KOD NO	mm		FİYAT/TL
H26-130	130	6	

H27-130

Elektronikçi Yassı Kargaburun



Paslanmaz Çelik

KOD NO	mm		FİYAT/TL
H27-130	130	6	

H20-W04

4 Parça Elektronikçi Pense Takımı (Deri Çantalı)



KOD NO		FİYAT/TL
H20-W04	1	

4PC: H20S-120SB, H21S-125SB, H23S-130, H27-130

H20-W06

6 Parça Elektronikçi Pense Takımı (Deri Çantalı)



KOD NO		FİYAT/TL
H20-W06	1	

6 PC: H20S-120SB, H21S-125SB, H23S-130, H25-155, H26-130, H27-130



H30S-110SB

Elektronikçi Yan Keski (Açılı Kesim)



Paslanmaz Çelik

KOD NO	mm	Ø mm		FİYAT/TL
H30S-110SB	110	1.0	6	
			Kart Bedeli	
			6	

Teşhir kartlı sipariş için = Ürün Kodu + X

H30S-110FL

Elektronikçi Yan Keski (Sıfır Kesim)

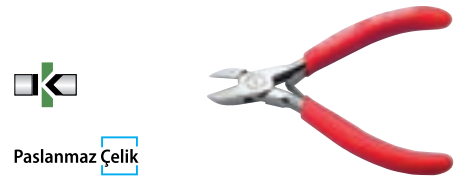

Paslanmaz Çelik

KOD NO	mm	Ø mm		FİYAT/TL
H30S-110FL	110	1.0	6	
			Kart Bedeli	
			6	

Teşhir kartlı sipariş için = Ürün Kodu + X

H30C-105SB

Elektronikçi Yan Keski (Mini Kafa - Açılı Kesim)



Paslanmaz Çelik

KOD NO	mm	Ø mm		FİYAT/TL
H30C-105SB	105	1.0	6	
			Kart Bedeli	
			6	

Teşhir kartlı sipariş için = Ürün Kodu + X

H30T-110SB

Elektronikçi Yan Keski (Konik Kafa - Açılı Kesim)



Paslanmaz Çelik

KOD NO	mm	Ø mm		FİYAT/TL
H30T-110SB	110	1.0	6	
			Kart Bedeli	
			6	

Teşhir kartlı sipariş için = Ürün Kodu + X

H31S-120SB

Elektronikçi Tepe Keski



Paslanmaz Çelik



KOD NO	mm	Ø mm		FİYAT/TL
H31S-120SB	120	1.0	6	
			Kart Bedeli	
			6	

Teşhir kartlı sipariş için = Ürün Kodu + X

H31N-120SB

Elektronikçi Eğri Tepe Keski (Dar Kesici Ağzılı)



Paslanmaz Çelik



KOD NO	mm	Ø mm		FİYAT/TL
H31N-120SB	120	1.0	6	
			Kart Bedeli	
			6	

Teşhir kartlı sipariş için = Ürün Kodu + X

H33S-120

Elektronikçi Kargaburun (Dişli Tutma Yüzeyi)



Paslanmaz Çelik



KOD NO	mm		FİYAT/TL
H33S-120	120	6	
		Kart Bedeli	
		6	

Teşhir kartlı sipariş için = Ürün Kodu + X

H33F-120

Elektronikçi Kargaburun (Dişsiz Tutma Yüzeyi)



Paslanmaz Çelik



KOD NO	mm		FİYAT/TL
H33F-120	120	6	
		Kart Bedeli	
		6	

Teşhir kartlı sipariş için = Ürün Kodu + X

H34S-115

Elektronikçi Eğri Kargaburun



Paslanmaz Çelik



KOD NO	mm		FİYAT/TL
H34S-115	115	6	
		Kart Bedeli	
		6	

Teşhir kartlı sipariş için = Ürün Kodu + X

H35S-140

Elektronikçi İğne Kargaburun



Paslanmaz Çelik



KOD NO	mm		FİYAT/TL
H35S-140	140	6	
		Kart Bedeli	
		6	

Teşhir kartlı sipariş için = Ürün Kodu + X

H36-120

Elektronikçi Yuvarlak Kargaburun



Paslanmaz Çelik

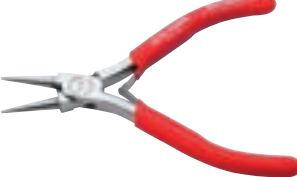

KOD NO	mm		FİYAT/TL
H36-120	120	6	
		Kart Bedeli	
		6	

Teşhir kartlı sipariş için = Ürün Kodu + X

H37-120

Elektronikçi Yassı Kargaburun



Paslanmaz Çelik

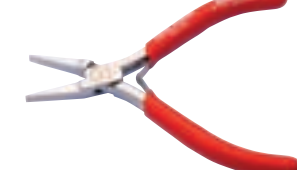

KOD NO	mm		FİYAT/TL
H37-120	120	6	
		Kart Bedeli	
		6	

Teşhir kartlı sipariş için = Ürün Kodu + X

H30-W04

4 Parça Elektronikçi Pense Takımı (Deri Çantalı)



Paslanmaz Çelik

KOD NO		FİYAT/TL
H30-W04	1	

4 PC: H30S-110SB, H31S-120SB, H33S-120, H37-120

H30-W06

6 Parça Elektronikçi Pense Takımı (Deri Çantalı)



Paslanmaz Çelik

KOD NO		FİYAT/TL
H30-W06	1	

6 PC: H30S-110SB, H31S-120SB, H33S-120, H35S-140, H36-120, H37-120

H30-W10

10 Parça Elektronikçi Pense-Tornavida Seti (Deri Çantalı)



KOD NO	FİYAT/TL
H30-W10	



H30S-110SB



H33S-120



H35S-140



H01 1.5x40, 2.0x60, 2.5x80, 3.0x80 mm



H02 PH00x60, PH0x60 mm

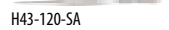

H43-120-SA

8 Mikro Torna Vidaları ve Penseler

H40-AA-SA
Sivri Uçlu Cımbız



KOD NO	mm		FİYAT/TL
H40-AA-SA	130	1	

H40-3C-SA
Sivri Uçlu Cımbız

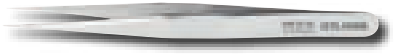

KOD NO	mm		FİYAT/TL
H40-3C-SA	110	1	

H40-00-SA
Sivri Uçlu Cımbız



KOD NO	mm		FİYAT/TL
H40-00-SA	120	1	

H40-5-SA
İğne Uçlu Cımbız



KOD NO	mm		FİYAT/TL
H40-5-SA	110	1	

H40-1-SA
Sivri Uçlu Cımbız



KOD NO	mm		FİYAT/TL
H40-1-SA	120	1	

H40-7-SA
İğne Uçlu Cımbız (Eğik)



KOD NO	mm		FİYAT/TL
H40-7-SA	120	1	

H40-2A-SA
Yuvarlak Uçlu Cımbız



KOD NO	mm		FİYAT/TL
H40-2A-SA	115	1	

H43G-150-SA
İnce Uçlu Cımbız (Merkezleme Pimli)



KOD NO	mm		FİYAT/TL
H43G-150-SA	150	1	

H43G-150B-SA
İnce Uçlu Cımbız (Merkezleme Pimli - Eğik)



KOD NO	mm		FİYAT/TL
H43G-150B-SA	155	1	

H43 Serisi
Küt Uçlu Cımbızlar



KOD NO	mm		FİYAT/TL
H43-120-SA	120	1	
H43-140-SA	140	1	

H44-160-SA
Çapraz Cımbız



KOD NO	mm		FİYAT/TL
H44-160-SA	160	1	

H44-160B-SA
Çapraz Cımbız (Eğik)



KOD NO	mm		FİYAT/TL
H44-160B-SA	160	1	

H44T-160-SA
Çapraz Cımbız (Düz - Geniş Tutma Yüzeyle)



KOD NO	mm		FİYAT/TL
H44T-160-SA	160	1	

H43-125B-SA
Küt Uçlu Cımbız (Eğik)



KOD NO	mm		FİYAT/TL
H43-125B-SA	125	1	

H45D-150-SA
İzoleli Cımbız



KOD NO	mm		FİYAT/TL
H45D-150-SA	150	1	

H45D-150B-SA
İzoleli Cımbız (Eğik)



KOD NO	mm		FİYAT/TL
H45D-150B-SA	150	1	

H40-R04
4 Parça Cımbız Seti



KOD NO		FİYAT/TL
H40-R04	10	

H44-115-SA	H43T-110-SA
H43-120-SA	H43-125B-SA

H55

Gazlı Lehim havyası



Güç ayarlı, yedek uç mevcuttur

KOD NO	mm		FİYAT/TL
H55	185	1	

H55-SC010

Konik Tip Yedek Uç (H55 için)



KOD NO	mm		FİYAT/TL
H55-SC010	1.0	6•	

H59AL

Alüminyum Lehim Pompası (Teflon Uç)



KOD NO	mm		FİYAT/TL
H59AL	195	6•	

H60-3

3 Parça Lehim Sökme Takımı



Tek bir sette kanca, rayba, bıçak, kazıyıcı, fırça ve çatal uçları

KOD NO	mm		FİYAT/TL
H60-3	175	6	

H57-1516

Lehim Fitolü



KOD NO	W / mm	m		FİYAT/TL
H57-1516	1.5	1.5	1	

H62-YC

Antistatik Bileklik (Kablolu)



Statik elektrikten koruma, direnç: <10K Ohm (Bilek Kayışı), 1M Ohm% 10 (Kablo)

KOD NO		FİYAT/TL
H62-YC	6	

H63

Fiberglas Kazıma Fırçası



Kontaktların temizlenmesi için, döner mekanizma, plastik kasa

KOD NO	mm		FİYAT/TL
H63	120	6•	

H64

Toz Fırçası



Siyah kıllar ve ahşap sap

KOD NO	mm		FİYAT/TL
H64	160	6•	

H65-10

10 Parça Plastik Ayar Takımı



KOD NO		FİYAT/TL
H65-10	1	

8 Mikro Tornavidalar ve Penseler

H99-N80 80 Parça Elektronikçi Teknisyen Alet Seti 80 PARÇA

yeni

- Profesyonel elektronik teknisyeni için mükemmel alet takımı
- Sadece içerik olarak veya Raptor alet çantaları ile takım olarak sipariş edilebilir



B09 3 PC
5x5.5, 6x7, 8x10 mm



B21-B
150 mm



LT/9 9 PC
1.5, 2, 2.5, 3, 4, 5, 6, 8, 10 mm



6105CP
3.0 mm



E01-41-0160
160 mm



E06-41-0140
140 mm



E15-41-0160
160 mm



E25-AS06



E25-MIC



F10M 2 PC
4.5x100, 6.0x150 mm



H01 4 PC
1.5, 2, 2.5, 3 mm



H02 2 PC
PH00, PH0



H04 3 PC
T5, T8, T10



H99-JK-05
4-in-1



G80-MDC2



Z/40
(4.0/4.0) x 100 mm



Z/12
(PH1/PH2) x 100 mm



H30S-110SB
110 mm



H31S-120SB
120 mm



H33S-120
120 mm



H37-120
120 mm



H43-120-SA
120 mm



H43-125B-SA
125 mm



H59AL
195 mm



H60-3 3 PC
175 mm

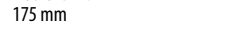

H62-YC



H63
120 mm



H64
160 mm



H65-10 10 PC



J17-190
190 mm



J46CPM
9 mm



J75-R06 6 PC



P05-0316
3M x 16 mm



R11-PEN
100 Lümen



R20RP
Ø30 x 175 mm



R36-1



R36-2



R36-3



R36-4



C00WLR3023C
30W / 400°C / 230V

Weller



H57-1516
Ø 1.2 mm



izole Bant

3M



R21P



Havva Ucu Temizleyici

STANNOL



80 Parça Elektronikçi Teknisyen Alet Seti

Sadece içerik

Çantalı Alet Setleri

(H99-N80+A32)

(H99-N80+A32H)



KOD NO

H99-N80

H99-N80A32

H99-N80A32H

FİYAT / TL

9 Tesisatçı Aletleri

127 | 128



I01 Serisi

Maşalı Boru Anahtarları (90° Çene)



KOD NO	Ø"	mm	📦	FİYAT/TL
I01-10	1	320	1	
I01-15	1-1/2	425	1	
I01-20	2	555	1	

I02 Serisi

Maşalı Boru Anahtarları (S Formlu Çene)



KOD NO	Ø"	mm	📦	FİYAT/TL
I02-10	1	320	1	
I02-15	1-1/2	425	1	
I02-20	2	535	1	

I01-/A Serisi

Yedek Somunlar (I01, I02 Serisi için)



KOD NO	🔧	📦	FİYAT/TL
I01-10/A	1"	6	
I01-15/A	1-1/2"	6	
I01-20/A	2"	6	

I06-2 Serisi

Ağır Sanayi Tipi Boru Anahtarları



KOD NO	Ø"	mm	📦	FİYAT/TL
I06-10-2	1-1/2	250	1	
I06-12-2	2	300	1	
I06-14-2	2	350	1	
I06-18-2	2-1/2	450	1	
I06-24-2	3	600	1	
I06-36-2	5	900	1	

I06-2/A Serisi

Yedek Kafalar (I06-2 Serisi için)



KOD NO	🔧	📦	FİYAT/TL
I06-10-2/A	I06-10-2	1	
I06-12-2/A	I06-12-2	1	
I06-14-2/A	I06-14-2	1	
I06-18-2/A	I06-18-2	1	
I06-24-2/A	I06-24-2	1	
I06-36-2/A	I06-36-2	1	

I06-2/B Serisi

Yedek Somunlar (I06-2 Serisi için)



KOD NO	🔧	📦	FİYAT/TL
I06-10-2/B	I06-10-2	6	
I06-12-2/B	I06-12-2	6	
I06-14-2/B	I06-14-2	6	
I06-18-2/B	I06-18-2	6	
I06-24-2/B	I06-24-2	6	
I06-36-2/B	I06-36-2	6	

I11 Serisi

Zincirli Boru Anahtarları



KOD NO	Ø"	mm	📦	FİYAT/TL
I11-40	4	900	1	
I11-60	6	1000	1	

I11-R Serisi

Yedek Zincirler (I11 Serisi için)



KOD NO	🔧	📦	FİYAT/TL
I11-40R	I11-40	1	
I11-60R	I11-60	1	

I12-40

Mini Zincirli Boru Anahtarı



KOD NO	Ø"	mm	📦	FİYAT/TL
I12-40	4	300	1	

I12-40R

Yedek Zincir (I12-40 için)



KOD NO	🔧	📦	FİYAT/TL
I12-40R	I12-40	1	

9 Tesisatçı Aletleri

I21-42-2
Profesyonel PPRC Boru Makası



KOD NO	Ø max. mm	mm		FİYAT/TL
I21-42-2	42	230	6	



I21-42-2R	I21-42-2 için	1
-----------	---------------	---

I20-190
PPRC Boru Makası



KOD NO	Ø max. mm	mm		FİYAT/TL
I20-190	42	190	8	



I20-190R	I20-190 için	1
----------	--------------	---

I30-2
Çelik Boru Kesici



KOD NO	Ø mm	mm		FİYAT/TL
I30-2	10-60	380	1	



I30-2R	32	1 pk.
--------	----	-------

I32-2
Bakır Boru Kesici



KOD NO	Ø mm	mm		FİYAT/TL
I32-2	3-30	150	12	



I32-2R	18	1 pk.
--------	----	-------

I34
Teleskopik Bakır Boru Kesici



KOD NO	Ø mm	mm		FİYAT/TL
I34	6-35	150	5	



I34-2R	18	1 pk.
--------	----	-------

I38-2
Mini Bakır Boru Kesici



KOD NO	Ø mm	mm		FİYAT/TL
I38-2	3-16	50	50	



I32-2R	18	1 pk.
--------	----	-------



I50
Havşa Açma Takımı



KOD NO	KAPASİTE (Ø mm)		FİYAT/TL
I50	5-16	1	

10 Kesici Aletler ve Eğeler

129 | 139



J04-250L

Mafsallı Sac Makası (Sol Kesim)



Paslanmaz çelik | max. 0.9 mm | Soğuk çekim sac | max. 1.2 mm

KOD NO	mm	mm		FİYAT/TL
J04-250L	40	250	6	

J04-250R

Mafsallı Sac Makası (Sağ Kesim)



Paslanmaz çelik | max. 0.9 mm | Soğuk çekim sac | max. 1.2 mm

KOD NO	mm	mm		FİYAT/TL
J04-250R	40	250	6	

J04-R03

3 Parça Mafsallı Sac Makası Takımı (Deri Çantalı)



KOD NO		FİYAT/TL
J04-R03	1	



J04-250L J04-250S J04-250R

J04-250S

Mafsallı Sac Makası (Düz Kesim)



Paslanmaz çelik | max. 0.9 mm | Soğuk çekim sac | max. 1.2 mm

KOD NO	mm	mm		FİYAT/TL
J04-250S	40	250	6	

J04-300S

Mafsallı Sac Makası (Düz Kesim-Uzun Ağız)



Paslanmaz çelik | max. 0.9 mm | Soğuk çekim sac | max. 1.2 mm

KOD NO	mm	mm		FİYAT/TL
J04-300S	83	300	6	

J01 Serisi

Sac Makasları



Paslanmaz çelik | max. 0.5 mm | Soğuk çekim sac | max. 1.0 mm

KOD NO	mm	YÖN		FİYAT/TL
J01-250L	250	sol	6	
J01-250R	250	sağ	6	

J04H-250L

Ofset Sac Makası (Sol Kesim)

yeni



Paslanmaz çelik | max. 0.9 mm | Soğuk çekim sac | max. 1.2 mm

KOD NO	mm	mm		FİYAT/TL
J04H-250L	40	250	6	

J04H-250R

Ofset Sac Makası (Sağ Kesim)

yeni



Paslanmaz çelik | max. 0.9 mm | Soğuk çekim sac | max. 1.2 mm

KOD NO	mm	mm		FİYAT/TL
J04H-250R	40	250	6	

J06-2 Serisi

Sac Makasları (İngiliz Modeli)

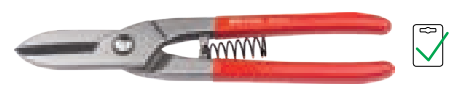

Paslanmaz çelik | max. 0.5 mm | Soğuk çekim sac | max. 1.0 mm

KOD NO	mm	mm		FİYAT/TL
J06-200-2	46	200	6	
J06-250-2	57	250	6	
J06-300-2	68	300	6	

10 Kesici Aletler ve Eęer

J10 Serisi

Demir Makasları

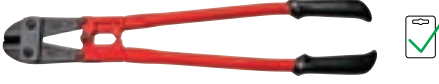

KOD NO	mm	mm		FİYAT/TL
J10-450	450	6	1	
J10-600	600	8	1	
J10-750	750	10	1	
J10-900	900	12	1	

J10-R Serisi

Yedek Aęızlar (J10 Serisi için)



KOD NO			FİYAT/TL
J10-450R	J10-450	1	
J10-600R	J10-600	1	
J10-750R	J10-750	1	
J10-900R	J10-900	1	

J16-180S

Kuyumcu Makası (Düz Aęız)

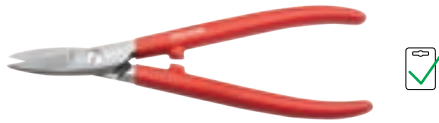

KOD NO	mm	mm		FİYAT/TL
J16-180S	31	180	6	

J16-180B

Kuyumcu Makası (Eęik Aęız)

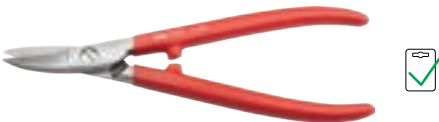

KOD NO	mm	mm		FİYAT/TL
J16-180B	29	180	6	

J19-220

Kablo Kanalı Makası

Yeni



KOD NO	DERECE	mm		FİYAT/TL
J19-220	45-135°	220	1	

J17-190

Çok Amaçlı Makas (Düz Aęız)



Paslanmaz Çelik

KOD NO	mm	mm		FİYAT/TL
J17-190	50	190	6	

J17-190B

Çok Amaçlı Makas (Eęik Aęız)



Paslanmaz Çelik

KOD NO	mm	mm		FİYAT/TL
J17-190B	40	190	6	

J18 Serisi

Ofis Makasları



Paslanmaz Çelik

KOD NO	mm	mm		FİYAT/TL
J18-230	84	230	10	
J18-250	104	250	10	

E61-K1160

Aramit İplik Makası (Kevlar)



KOD NO	mm		FİYAT/TL
E61-K1160	160	12	

J22-215R

Baę Makası (Döner Saplı)



KOD NO	mm		FİYAT/TL
J22-215R	210	6	
J22-215RR	Yedek Bıçak	1	

J22-215P

Baę Makası (Alüminyum Dövme Saplar)



KOD NO	mm		FİYAT/TL
J22-215P	210	6	
J22-215PR	Yedek Bıçak	1	

J22-215C

Baę Makası (Alüminyum Döküm Saplar)



KOD NO	mm		FİYAT/TL
J22-215C	215	6	
J22-215CR	Yedek Bıçak	1	

J23-190

Hasat Makası



KOD NO	mm	mm		FİYAT/TL
J23-190	53	190	10	

J22A-200

Örs Tipi Bağ Makası



KOD NO	mm			FİYAT/TL
J22A-200	200	12		
J22A-200R	Yedek Bıçak	1		

J30-300

Testere Kolu (Saptan Ayarlı)



KOD NO	mm		FİYAT/TL
J30-300	430	6	

J32-300

Testere Kolu



KOD NO	mm		FİYAT/TL
J32-300	425	6	

J35.B Serisi

Testere Yedekleri (HSS Bi-Metal) - 10'lu Paket



Kırılmaz

Fiyatlar 10 adetlik paket fiyatlandır

KOD NO	mm	TPI*		FİYAT/TL
J35-18B	300	18	10 pk.	
J35-24B	300	24	10 pk.	

*TPI: İnç başına düşen diş sayısı

J36-150

Mini Testere Kolu



KOD NO	mm		FİYAT/TL
J36-150	260	12	

J36-R

Mini Testere Yedeği - 10'lu Paket



Fiyat 10 adetlik paket fiyatıdır

KOD NO	mm	TPI*		FİYAT/TL
J36-R	150	18	10 pk.	

*TPI: İnç başına düşen diş sayısı

J44-067

Alçıpan Testeresi



KOD NO	mm/inch	mm		FİYAT/TL
J44-067	160-6"	300	12	

J40 Serisi

Delik Açma Testereleeri (Super HSS Bi-Metal)

DuraMAX



DuraMAX kalitesi, 4/6 değişken diş yapısı, süper HSS alaşımli dişler, yay çeliği gövde

KOD NO	mm	"	mm		FİYAT/TL
J40-014	14	9/16	55	6	
J40-016	16	5/8	55	6	
J40-017	17	11/16	55	6	
J40-019	19	3/4	50	6	
J40-020	20	25/32	50	6	
J40-021	21	13/16	50	6	
J40-022	22	7/8	50	6	
J40-024	24	15/16	50	6	
J40-025	25	1	50	6	
J40-027	27	1-1/16	50	6	
J40-029	29	1-1/8	50	6	
J40-030	30	1-3/16	50	6	
J40-032	32	1-1/4	50	6	
J40-033	33	1-5/16	50	6	
J40-035	35	1-3/8	50	6	
J40-037	37	1-7/16	50	6	
J40-038	38	1-1/2	44	6	
J40-040	40	1-9/16	44	6	
J40-041	41	1-5/8	44	6	
J40-043	43	1-11/16	44	6	
J40-044	44	1-3/4	44	6	
J40-046	46	1-13/16	44	6	
J40-048	48	1-7/8	44	6	
J40-051	51	2	44	6	
J40-052	52	2-1/16	44	6	
J40-054	54	2-1/8	44	6	
J40-057	57	2-1/4	44	6	
J40-060	60	2-3/8	44	6	
J40-064	64	2-1/2	44	6	
J40-065	65	2-9/16	44	6	
J40-067	67	2-5/8	44	6	
J40-068	68	2-11/16	44	6	
J40-070	70	2-3/4	44	6	
J40-073	73	2-7/8	44	6	
J40-076	76	3	44	6	
J40-079	79	3-1/8	44	6	
J40-083	83	3-1/4	44	6	
J40-086	86	3-3/8	44	6	
J40-089	89	3-1/2	44	6	
J40-092	92	3-5/8	44	6	
J40-095	95	3-3/4	44	6	
J40-098	98	3-7/8	44	6	
J40-102	102	4	44	6	
J40-105	105	4-1/8	44	6	
J40-111	111	4-3/8	44	6	
J40-114	114	4-1/2	44	6	
J40-121	121	4-3/4	44	6	
J40-127	127	5	44	6	
J40-140	140	5-1/2	44	6	
J40-152	152	6	44	6	



10 Kesici Aletler ve Eğeler

J40-A1

Adaptör No.1 (J40 Serisi için) - Altıgen Şaft



Sürücü: 11 mm (7/16"), Yiv: 1/2" - 20 UNF

KOD NO	mm	mm	FİYAT/TL
J40-A1	14-29	93	10

J40-A2

Adaptör No.2 (J40 Serisi için) - Altıgen Şaft



Sürücü: 11 mm (7/16"), Yiv: 5/8" - 18 UNF

KOD NO	mm	mm	FİYAT/TL
J40-A2	30-152	116	10

J40-A3

Adaptör No.3 (J40 Serisi için) - SDS-Plus Şaft



Sürücü: SDS-Plus, Yiv: 1/2" - 20 UNF

KOD NO	mm	mm	FİYAT/TL
J40-A3	14-29	130	6

J40-A4

Adaptör No.4 (J40 Serisi için) - SDS-Plus Şaft



Sürücü: SDS-Plus, Yiv: 5/8" - 18 UNF

KOD NO	mm	mm	FİYAT/TL
J40-A4	30-152	153	6

J40-PD Serisi

Yedek Merkezleme Uçları (Adaptörler için)

J40-PD1



J40-PD2



KOD NO	FİYAT/TL
J40-PD1	A1 ve A3 için 6•
J40-PD2	A2 ve A4 için 6•

J40-P13

13 Parça Delik Açma Testere Takımı

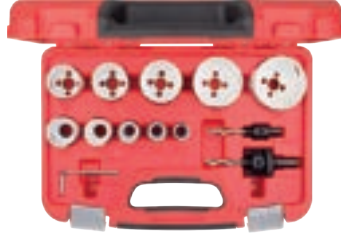

DuraMAX

KOD NO	FİYAT/TL
J40-P13	1



J40 20, 22, 25, 32, 35, 40, 44, 51, 60, 64 mm

J40-A1 1/2" - 20 UNF

J40-A2 5/8" - 18 UNF

L 4 mm

J40R-ME150

Tilki Kuyruğu Bıçağı (Metal için) - 5'li Paket



İnce kalınlıktaki saclar, borular ve profiller içindir, 18 TPI* diş, bimetal gövde

Belirtilen fiyat 5'li paket fiyatıdır

KOD NO	Ref.	mm	FİYAT/TL
J40R-ME150	S922EF	150	5

J40R-MB150

Tilki Kuyruğu Bıçağı (Metal için) - 5'li Paket



Kalın saclar, borular ve profiller içindir, 14 TPI* diş, bimetal gövde

Belirtilen fiyat 5'li paket fiyatıdır

KOD NO	Ref.	mm	FİYAT/TL
J40R-MB150	S922BF	150	5

J40R-MB225

Tilki Kuyruğu Bıçağı (Metal için)



Kalın saclar, borular ve profiller içindir, 14 TPI* diş, bimetal gövde

Belirtilen fiyatlar 5'li ve 100'lü paket fiyatlarıdır

KOD NO	Ref.	mm	FİYAT/TL
J40R-MB225	S1122BF	225	5
J40R-MB225B	S1122BF	225	100

J40R-DH225

Tilki Kuyruğu Bıçağı (Metal ve Ahşap için)



Çivili ahşap, metal saclar, borular ve alüminyum profiller için, 10 TPI* diş, bimetal gövde

Belirtilen fiyatlar 5'li ve 100'lü paket fiyatlarıdır

KOD NO	Ref.	mm	FİYAT/TL
J40R-DH225	S1122HF	225	5
J40R-DH225B	S1122HF	225	100

J40R-PV210F

Tilki Kuyruğu Bıçağı (Palet Tamiri için)



Palet tamirinde kullanım içindir, 10/14 TPI* diş, bimetal gövde

Belirtilen fiyatlar 5'li ve 100'lü paket fiyatlarıdır

KOD NO	Ref.	mm	FİYAT/TL
J40R-PV210F	S722VFR	210	5
J40R-PV210FB	S722VFR	210	100

J40R-WL240

Tilki Kuyruğu Bıçağı (Ahşap için) - 5'li Paket

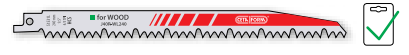

Kaba ahşap, çivisiz ahşap, ağaç budama ve yakacak odun için, 4/5 TPI* diş, HCS gövde

Belirtilen fiyat 5'li paket fiyatıdır

KOD NO	Ref.	mm	FİYAT/TL
J40R-WL240	S1531L	240	5

J40J-WB100

Dekupaj Testere Bıçağı (Ahşap için-Normal Kesim) - 5'li Paket



Sert ve yumuşak ahşap, kontrplak ve plastik malzemeler için, 8 TPI* diş, orta seviye kaba kesim, HCS, T tip sap

Belirtilen fiyat 5'li paket fiyatıdır

KOD NO	Ref.	mm	FİYAT/TL
J40J-WB100	T111C	100	50 pk

J40J-WF100

Dekupaj Testere Bıçağı (Ahşap için-Hızlı Kesim) - 5'li Paket



Sert ve yumuşak ahşap, kontrplak ve plastik malzemeler için, 6 TPI* diş, hızlı ve düz kesim, HCS, T tip sap

Belirtilen fiyat 5'li paket fiyatıdır

KOD NO	Ref.	mm	FİYAT/TL
J40J-WF100	T144D	100	50 pk

J40J-WF100C

Dekupaj Testere Bıçağı (Ahşap için-Hızlı/Eğik Kesim) - 5'li Paket



Sert ve yumuşak ahşap, kontrplak ve plastik malzemeler için, 6 TPI* diş, hızlı ve eğri kesim, HCS, T tip sap
Belirtilen fiyat 5'li paket fiyatıdır

KOD NO	Ref.	mm	mm	FİYAT/TL
J40J-WF100C	T244D	100	50 pk	

J40J-WC100

Dekupaj Testere Bıçağı (Ahşap için-Temiz Kesim) - 5'li Paket



Sert ve yumuşak ahşap, kontrplak ve plastik malzemeler için, 5-6 TPI* diş, temiz ve çapaksız kesim, HCS, T tip sap
Belirtilen fiyat 5'li paket fiyatıdır

KOD NO	Ref.	mm	mm	FİYAT/TL
J40J-WC100	T101D	100	50 pk	

J40J-MB075

Dekupaj Testere Bıçağı (Metal için-Normal Kesim) - 5'li Paket



3 mm kalınlığa kadar metalleri kesim için, 24 TPI* diş, düz kesim, HCS, T tip sap
Belirtilen fiyat 5'li paket fiyatıdır

KOD NO	Ref.	mm	mm	FİYAT/TL
J40J-MB075	T118A	75	50 pk	

J40J-A100

Dekupaj Testere Bıçağı (Alüminyum için) - 5'li Paket



Alüminyum, demir dışı metal ve plastik kesim için, 8 TPI* diş, düz kesim HCS, T tip sap
Belirtilen fiyat 5'li paket fiyatıdır

KOD NO	Ref.	mm	mm	FİYAT/TL
J40J-A100	T127D	100	50 pk	

J45CPM

C-Pro Maket Bıçağı (Metal Gövde) - 18 mm



2 adet J45-R bıçak içerir

KOD NO	mm	mm	FİYAT/TL
J45CPM	155	18	24 •

Teşhir kartlı sipariş için = Ürün Kodu + X

J45CP

C-Pro Maket Bıçağı - 18 mm



2 adet J45-R bıçak içerir

KOD NO	mm	mm	FİYAT/TL
J45CP	165	18	24 •

Teşhir kartlı sipariş için = Ürün Kodu + X

J45CM

Compact Maket Bıçağı (Uzay Gri) - 18 mm



2 adet J45-R bıçak içerir

KOD NO	mm	mm	FİYAT/TL
J45CM	163	18	24 •

J45C

Compact Maket Bıçağı - 18 mm



2 adet J45-R bıçak içerir

KOD NO	mm	mm	FİYAT/TL
J45C	163	18	24 •

J45C/D

Compact Maket Bıçağı (Vida Kilitli) - 18 mm



1 adet J45-R bıçak içerir

KOD NO	mm	mm	FİYAT/TL
J45C/D	155	18	30

J45C/T

Compact Maket Bıçağı (Vida Kilitli-Kuyruklu)-18 mm



1 adet J45-R bıçak içerir

KOD NO	mm	mm	FİYAT/TL
J45C/T	160	18	30

J47SPQ

Katlanır Maket Bıçağı (Trapez Bıçaklı)



Yedek Bıçak Kodları

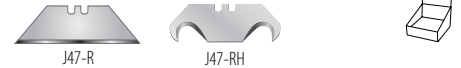

KOD NO	mm	mm	FİYAT/TL
J47SPQ	158	19	12 •

J47TK-S

Emniyetli Maket Bıçağı (Metal Gövde - Otomatik Geri Çekme)



KOD NO	mm	mm	FİYAT/TL
J47TK-S	175	19	10

J47TK

Maket Bıçağı (Metal Gövde)



KOD NO	mm	mm	FİYAT/TL
J47TK	175	19	10

10 Kesici Aletler ve Eğeler

J47C-S

Emniyetli Maket Bıçağı (Otomatik Geri Çekme)



KOD NO	mm	mm	mm	FİYAT/TL
J47C-S	150	19	30	

J49M

Jilet Uçlu Kazıma Bıçağı (Metal Gövde)



KOD NO	mm	mm	mm	FİYAT/TL
J49M	105	19	24	

J46CPM

C-Pro Maket Bıçağı (Metal Gövde) - 9 mm



Paslanmaz çelik bıçak yuvası, otomatik kilit mekanizması, cep klipsi, 1 adet J46-R bıçak içerir

KOD NO	mm	mm	mm	FİYAT/TL
J46CPM	145	9	36	

J46SL

Slim 9 Çelik Gövde Maket Bıçağı - 9 mm



İnce tasarım, paslanmaz çelik gövde, otomatik kilit mekanizması, cep klipsi, 1 adet J46-R bıçak içerir

KOD NO	mm	mm	mm	FİYAT/TL
J46SL	145	9	24	

J46C

Compact Maket Bıçağı - 9 mm



Paslanmaz çelik bıçak yuvası, otomatik kilit mekanizması, cep klipsi, 1 adet J46-R bıçak içerir

KOD NO	mm	mm	mm	FİYAT/TL
J46C	150	9	36	

J45-RDM

18 mm Maket Bıçağı Yedeği - 10'lu Paket



Belirtilen fiyat 10'lu paket fiyatıdır

KOD NO	mm	mm	mm	FİYAT/TL
J45-RDM	108	18	10 pk. •	

J45-R

18 mm Maket Bıçağı Yedeği - 10'lu Paket



Belirtilen fiyat 10'lu paket fiyatıdır

KOD NO	mm	mm	mm	FİYAT/TL
J45-R	108	18	10 pk. •	

J46-R

9 mm Maket Bıçağı Yedeği - 10'lu Paket



Belirtilen fiyat 10'lu paket fiyatıdır

KOD NO	mm	mm	mm	FİYAT/TL
J46-R	85	9	10 pk. •	

J46-R/30

9 mm Maket Bıçağı Yedeği (Kretuar Tip) - 10'lu Paket



Belirtilen fiyat 10'lu paket fiyatıdır

KOD NO	mm	mm	mm	FİYAT/TL
J46-R/30	85	9	10 pk. •	

J47-R

Trapez Tipi Maket Bıçağı Yedeği - 10'lu Paket



Belirtilen fiyat 10'lu paket fiyatıdır

KOD NO	mm	mm	mm	FİYAT/TL
J47-R	60	19	10 pk. •	

J47-RS

Trapez Tipi Maket Bıçağı Yedeği (Delikli) - 10'lu Pk.



J47C-S için yedek bıçak

Belirtilen fiyat 10'lu paket fiyatıdır

KOD NO	mm	mm	mm	FİYAT/TL
J47-RS	60	19	10 pk. •	

DuraMAX

J47-RH

Kanca Tipi Maket Bıçağı Yedeği - 10'lu Paket



Belirtilen fiyat 10'lu paket fiyatıdır

KOD NO	mm	mm	mm	FİYAT/TL
J47-RH	49	19	10 pk. •	

J49-R

Kazıma Bıçağı Yedeği - 10'lu Paket



Belirtilen fiyat 10'lu paket fiyatıdır

KOD NO	mm	mm	mm	FİYAT/TL
J49-R	38.3	19	10 pk. •	

J80-200

Düz Raspa



KOD NO	mm	mm	mm	FİYAT/TL
J80-200	20	200	10	

J81-200

Üç Kenarlı Raspa



KOD NO	mm	mm	mm	FİYAT/TL
J81-200	10	200	10	

J82 Serisi

Üç Kenarlı Çukur Raspalar



KOD NO	mm	mm	mm	FİYAT/TL
J82-150	14	150	10	
J82-200	16	200	10	

J83-200

Üç Kenarlı Kaşık Raspa



KOD NO	mm	mm	mm	FİYAT/TL
J83-200	14	200	6	

Ceta Form Eğeler



E Tesviyeci eğeler – Şekillendirilmiş parçaların yüzey işlemlerinde kullanım için.

S Testere eğeleri – Ağaç testereleri ve benzer ince kenarları keskinleştirmek için.

R Törpü – Ağaç, deri ve benzer yumuşak malzemelerde kullanım için.

Çift kesim:
Çelik ve diğer malzemelerde kullanım.

Tek kesim:
Testere keskinleştirmek,
ince yüzey elde etmede kullanım.

Raspa kesim:
Ahşap ve yumuşak malzemelerde kullanım.

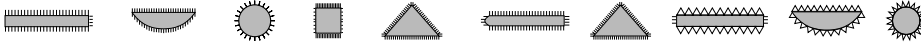

J55 Serisi Standart Eğeler



Çift kesim yüzeyler

KOD NO	mm "	mm	FİYAT/TL
Kalın			
J55-106	150 – 6"	16	12 •
J55-108	200 – 8"	20	12 •
J55-110	250 – 10"	25	12 •
J55-112	300 – 12"	30	6 •
Orta			
J55-206	150 – 6"	16	12 •
J55-208	200 – 8"	20	12 •
J55-210	250 – 10"	25	12 •
J55-212	300 – 12"	30	6 •
İnce			
J55-306	150 – 6"	16	12 •
J55-308	200 – 8"	20	12 •
J55-310	250 – 10"	25	12 •
J55-312	300 – 12"	30	6 •

J55-H Serisi Standart Eğeler (Ergonomik Saplı)



Özellikler J55 serisi ile aynıdır,
çift bileşenli ergonomik saplı

KOD NO	mm "	mm	FİYAT/TL
Kalın			
J55-106H	150 – 6"	16	6
J55-108H	200 – 8"	20	6
J55-110H	250 – 10"	25	6
J55-112H	300 – 12"	30	6
Orta			
J55-206H	150 – 6"	16	6
J55-208H	200 – 8"	20	6
J55-210H	250 – 10"	25	6
J55-212H	300 – 12"	30	6
İnce			
J55-306H	150 – 6"	16	6
J55-308H	200 – 8"	20	6
J55-310H	250 – 10"	25	6
J55-312H	300 – 12"	30	6

J55F Serisi

Konik Uçlu Yassı Eğeler



Çift kesim yüzeyler, uca doğru
incelen gövde ve kenarlar

KOD NO	mm "	mm	FİYAT/TL
Orta			
J55F-206	150 – 6"	16	12 •
J55F-208	200 – 8"	20	12 •
J55F-210	250 – 10"	25	12 •
J55F-212	300 – 12"	30	6 •

J55F-H Serisi

Konik Uçlu Yassı Eğeler (Ergonomik Saplı)



Özellikler J55F serisi ile aynıdır,
çift bileşenli ergonomik saplı

KOD NO	mm "	mm	FİYAT/TL
Orta			
J55F-206H	150 – 6"	16	6
J55F-208H	200 – 8"	20	6
J55F-210H	250 – 10"	25	6
J55F-212H	300 – 12"	30	6

J55W-206

Çilingir Eğesi



Çift kesim yüzeyler

KOD NO	mm "	mm	FİYAT/TL
Orta			
J55W-206	150 – 6"	15	12 •

J55W-206H

Çilingir Eğesi (Ergonomik Saplı)



Çift kesim yüzeyler

KOD NO	mm "	mm	FİYAT/TL
Orta			
J55W-206H	150 – 6"	15	6

10 Kesici Aletler ve Eğeler

J56 Serisi

Yarım Yuvarlak Eğeler



Çift kesim yüzeyler, uca doğru incelen gövde ve kenarlar



KOD NO	mm "	mm	FİYAT/TL
Kalın			
J56-106	150 – 6"	16	12•
J56-108	200 – 8"	20	12•
J56-110	250 – 10"	24.5	12•
J56-112	300 – 12"	29.5	6•
Orta			
J56-206	150 – 6"	16	12•
J56-208	200 – 8"	20	12•
J56-210	250 – 10"	24.5	12•
J56-212	300 – 12"	29.5	6•
İnce			
J56-306	150 – 6"	16	12•
J56-308	200 – 8"	20	12•
J56-310	250 – 10"	24.5	12•
J56-312	300 – 12"	29.5	6•

J56-H Serisi

Yarım Yuvarlak Eğeler (Ergonomik Saplı)



Özellikler J56 serisi ile aynıdır, çift bileşenli ergonomik saplı



KOD NO	mm "	mm	FİYAT/TL
Kalın			
J56-106H	150 – 6"	16	6
J56-108H	200 – 8"	20	6
J56-110H	250 – 10"	24.5	6
J56-112H	300 – 12"	29.5	6
Orta			
J56-206H	150 – 6"	16	6
J56-208H	200 – 8"	20	6
J56-210H	250 – 10"	24.5	6
J56-212H	300 – 12"	29.5	6
İnce			
J56-306H	150 – 6"	16	6
J56-308H	200 – 8"	20	6
J56-310H	250 – 10"	24.5	6
J56-312H	300 – 12"	29.5	6

J57 Serisi

Yuvarlak Eğeler



Çift kesim yüzeyler, uca doğru incelen gövde



KOD NO	mm "	mm	FİYAT/TL
Kalın			
J57-106	150 – 6"	6	12•
J57-108	200 – 8"	7.5	12•
J57-110	250 – 10"	9.5	12•
J57-112	300 – 12"	12	6•
Orta			
J57-206	150 – 6"	6	12•
J57-208	200 – 8"	7.5	12•
J57-210	250 – 10"	9.5	12•
J57-212	300 – 12"	12	6•

J57-H Serisi

Yuvarlak Eğeler (Ergonomik Saplı)



Özellikler J57 Serisi ile aynı, çift bileşenli ergonomik saplı



KOD NO	mm "	mm	FİYAT/TL
Kalın			
J57-106H	150 – 6"	6	6
J57-108H	200 – 8"	7.5	6
J57-110H	250 – 10"	9.5	6
J57-112H	300 – 12"	12	6
Orta			
J57-206H	150 – 6"	6	6
J57-208H	200 – 8"	7.5	6
J57-210H	250 – 10"	9.5	6
J57-212H	300 – 12"	12	6

J58 Serisi

Kare Eğeler



Çift kesim yüzeyler, uca doğru incelen gövde



KOD NO	mm "	mm	FİYAT/TL
Kalın			
J58-106	150 – 6"	6	12•
J58-108	200 – 8"	8	12•
J58-110	250 – 10"	9.5	12•
J58-112	300 – 12"	12	6•
Orta			
J58-206	150 – 6"	6	12•
J58-208	200 – 8"	8	12•
J58-210	250 – 10"	9.5	12•
J58-212	300 – 12"	12	6•

J58-H Serisi

Kare Eğeler (Ergonomik Saplı)



Özellikler J58 serisi ile aynıdır, çift bileşenli ergonomik saplı



KOD NO	mm "	mm	FİYAT/TL
Kalın			
J58-106H	150 – 6"	6	6
J58-108H	200 – 8"	8	6
J58-110H	250 – 10"	9.5	6
J58-112H	300 – 12"	12	6
Orta			
J58-206H	150 – 6"	6	6
J58-208H	200 – 8"	8	6
J58-210H	250 – 10"	9.5	6
J58-212H	300 – 12"	12	6



J59 Serisi

Üç Köşe Eğeler



Çift kesim yüzeyler, uca doğru incelen gövde



KOD NO	mm "	mm	FİYAT/TL
Kalın			
J59-106	150 – 6"	11	12 •
J59-108	200 – 8"	15	12 •
J59-110	250 – 10"	17.5	12 •
J59-112	300 – 12"	20	6 •
Orta			
J59-206	150 – 6"	11	12 •
J59-208	200 – 8"	15	12 •
J59-210	250 – 10"	17.5	12 •
J59-212	300 – 12"	20	6 •

J59-H Serisi

Üç Köşe Eğeler (Ergonomik Saplı)



Özellikler J59 serisi ile aynıdır, çift bileşenli ergonomik saplı



KOD NO	mm "	mm	FİYAT/TL
Kalın			
J59-106H	150 – 6"	11	6
J59-108H	200 – 8"	15	6
J59-110H	250 – 10"	17.5	6
J59-112H	300 – 12"	20	6
Orta			
J59-206H	150 – 6"	11	6
J59-208H	200 – 8"	15	6
J59-210H	250 – 10"	17.5	6
J59-212H	300 – 12"	20	6

J72-A Serisi

5 Parça Eğe Takımları (Kombinasyon A)



KOD NO	FİYAT/TL
J72-0851A	1
200 mm	
J55-108H, J55-208H, J56-108H, J57-108H, J58-108H	
J72-1051A	1
250 mm	
J55-110H, J55-210H, J56-110H, J57-110H, J58-110H	

J64 Serisi

Mil Eğeleri



Tek kesim yüzeyler, bir kenarı yuvarlak



KOD NO	mm "	mm	FİYAT/TL
Orta			
J64-206	150 – 6"	16	12 •
J64-208	200 – 8"	20	12 •
J64-210	250 – 10"	25	12 •
J64-212	300 – 12"	30	6 •

J64-H Serisi

Mil Eğeleri (Ergonomik Saplı)



Özellikler J64 serisi ile aynıdır, çift bileşenli ergonomik saplı



KOD NO	mm "	mm	FİYAT/TL
Orta			
J64-206H	150 – 6"	16	6
J64-208H	200 – 8"	20	6
J64-210H	250 – 10"	25	6
J64-212H	300 – 12"	30	6

J72-B Serisi

5 Parça Eğe Takımları (Kombinasyon B)



KOD NO	FİYAT/TL
J72-0851B	1
200 mm - Kalın Kesim	
J55-108H, J56-108H, J57-108H, J58-108H, J59-108H	
J72-0852B	1
200 mm - Orta Kesim	
J55-208H, J56-208H, J57-208H, J58-208H, J59-208H	

J65 Serisi

Üç Köşe Testere Eğeleri



Tek kesim yüzeyler, uca doğru incelen gövde



KOD NO	mm "	mm	FİYAT/TL
Kalın			
J65-106	150 – 6"	12	12 •
J65-107	175 – 7"	14	12 •
J65-108	200 – 8"	16	12 •
Orta			
J65-204	100 – 4"	6	12 •
J65-245	112 – 4-1/2"	7	12 •
J65-205	125 – 5"	7	12 •
J65-206	150 – 6"	9	12 •

J65-H Serisi

Üç Köşe Testere Eğeleri (Ergonomik Saplı)



Özellikler J65 serisi ile aynıdır, çift bileşenli ergonomik saplı



KOD NO	mm "	mm	FİYAT/TL
Kalın			
J65-106H	150 – 6"	12	6
J65-107H	175 – 7"	14	6
J65-108H	200 – 8"	16	6

J65D-207

Çift Ağızlı Testere Eğesi



Tek kesim yüzeyler



KOD NO	mm "	mm	FİYAT/TL
Orta			
J65D-207	175 – 7"	6	12 •

J66 Serisi

Yuvarlak Motor Eğeleri



Tek kesim yüzeyler



KOD NO	mm "	mm	FİYAT/TL
Orta			
J66-640	5/32	4	150 – 6" 12 •
J66-848	3/16	4.8	200 – 8" 12 •
J66-855	7/32	5.5	200 – 8" 12 •

10 Kesici Aletler ve Eğeler

J67 Serisi Standart Törpüler



Raspa kesim yüzeyler,
uca doğru incelen gövde



KOD NO	mm "	mm	FİYAT/TL
Kalın			
J67-108	200 – 8"	20	12 •
J67-110	250 – 10"	25	12 •

J67-H Serisi Standart Törpüler (Ergonomik Saplı)



Özellikler J67 serisi ile aynıdır,
çift bileşenli ergonomik saplı



KOD NO	mm "	mm	FİYAT/TL
Kalın			
J67-108H	200 – 8"	20	6
J67-110H	250 – 10"	25	6

J68 Serisi Yarım Yuvarlak Törpüler



Raspa kesim yüzeyler,
uca doğru incelen gövde



KOD NO	mm "	mm	FİYAT/TL
Kalın			
J68-108	200 – 8"	20	12 •
J68-110	250 – 10"	24	12 •
J68-112	300 – 12"	29	6 •

J68-H Serisi Yarım Yuvarlak Törpüler (Ergonomik Saplı)



Özellikler J68 serisi ile aynıdır,
çift bileşenli ergonomik saplı



KOD NO	mm "	mm	FİYAT/TL
Kalın			
J68-108H	200 – 8"	20	6
J68-110H	250 – 10"	24	6
J68-112H	300 – 12"	29	6

J70 Serisi Yuvarlak Törpüler



Raspa kesim yüzeyler,
uca doğru incelen gövde



KOD NO	mm "	mm	FİYAT/TL
Kalın			
J70-108	200 – 8"	8	12 •
J70-110	250 – 10"	10	12 •
J70-112	300 – 12"	12	6 •

J70-H Serisi Yuvarlak Törpüler (Ergonomik Saplı)



Özellikler J70 serisi ile aynıdır,
çift bileşenli ergonomik saplı



KOD NO	mm "	mm	FİYAT/TL
Kalın			
J70-108H	200 – 8"	8	6
J70-110H	250 – 10"	10	6
J70-112H	300 – 12"	12	6

J71 Serisi Ergonomik Eğe Sapları



Raspalar, standart ve testere eğelerle kullanım için, askı delikli çift bileşenli ergonomik sap

KOD NO	mm	FİYAT/TL
J71-03	95	12 •
J71-04	95	12 •
J71-05	103	12 •
J71-06	103	12 •

HANGİ SAP HANGİ EĞE İÇİN?

6" 7" 8" 10" 12"

Tesviyeci Eğeler

E	Eğeler	J71-03	J71-04	J71-05	J71-06
E	J55 Standart Eğe, J55F Konik Uçlu Yassı Eğe	-	J71-05	J71-05	J71-05
E	J56 Yarım Yuvarlak Eğe	J71-03	-	J71-05	J71-05
E	J57 Yuvarlak Eğe	J71-04	-	J71-04	J71-06
E	J58 Kare Eğe	J71-04	-	J71-04	J71-06
E	J59 Üçgen Eğe	J71-04	-	J71-04	J71-06

Testere Eğeleri

S	Eğeler	J71-03	J71-04	J71-05	J71-06
S	J64 Mil Eğesi	J71-03	-	J71-05	J71-05
S	J65 Üç Köşe Testere Eğesi	J71-05	J71-06	J71-06	-

Törpüler

R	Törpüler	J71-03	J71-04	J71-05	J71-06
R	J67 Standart Törpü	-	-	J71-05	J71-05
R	J68 Yarım Yuvarlak Törpü	-	-	J71-05	J71-05
R	J70 Yuvarlak Törpü	-	-	J71-04	J71-06

J75-H26

Yassı Saatçi Eđesi



KOD NO	mm	mm	FİYAT/TL
J75-H26	160 - 6"	7.5	12 •

J75-F26

Konik Uçlu Yassı Saatçi Eđesi



KOD NO	mm	mm	FİYAT/TL
J75-F26	160 - 6"	7.5	12 •

J75-HR26

Yarım Yuvarlak Saatçi Eđesi



KOD NO	mm	mm	FİYAT/TL
J75-HR26	160 - 6"	6.9	12 •

J75-R26

Yuvarlak Saatçi Eđesi



KOD NO	mm	mm	FİYAT/TL
J75-R26	160 - 6"	4	12 •

J75-R06

6 Parça Saatçi Eđe Takımı



KOD NO	FİYAT/TL
J75-R06	10

6 PC: J75-F26, J75-H26, J75-HR26, J75-R26, J75-S26, J75-TS26

J75-S26

Kare Saatçi Eđesi



KOD NO	mm	mm	FİYAT/TL
J75-S26	160 - 6"	3.5	12 •

J75-TS26

Üç Köşe Saatçi Eđesi



KOD NO	mm	mm	FİYAT/TL
J75-TS26	160 - 6"	5	12 •

J75-K26

Bıçak Tip Saatçi Eđesi



KOD NO	mm	mm	FİYAT/TL
J75-K26	160 - 6"	7.2	12 •

J75-B26

Barrette Tip Saatçi Eđesi



KOD NO	mm	mm	FİYAT/TL
J75-B26	160 - 6"	7	12 •

J75-R12

12 Parça Saatçi Eđe Takımı



KOD NO	FİYAT/TL
J75-R12	10

12 PC: J75-F26x2, J75-H26x2, J75-HR26, J75-R26, J75-S26, J75-TS26, J75-K26, J75-B26, J75-C26, J75-O26

J75-C26

Yarı Oval Saatçi Eđesi



KOD NO	mm	mm	FİYAT/TL
J75-C26	160 - 6"	6.6	12 •

J75-O26

Oval Saatçi Eđesi



KOD NO	mm	mm	FİYAT/TL
J75-O26	160 - 6"	4.6	12 •

J75M-R05

Kontakt Temizleme Eđesi



Elektrik kontaktlarının temizliğinde ve parlatılmasında kullanılır

Belirtilen fiyat 5 adet içindir

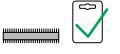

KOD NO	mm	mm	FİYAT/TL
J75M-R05	160 - 6"	8.0	1

J76-R06

6 Parça Elmas Eđe Takımı



KOD NO	FİYAT/TL
J76-R06	10

11 Çekiç ve Keskiçler

140 | 142



L01 Serisi

Tesviyeci Çekiçleri



KOD NO	gr	mm		FİYAT/TL
L01-100	100	265	6	
L01-200	200	280	6	
L01-300	300	300	6	
L01-500	500	320	6	
L01-1000	1000	360	6	
L01-1500	1500	380	4	
L01-2000	2000	400	4	

Yedek Sap (L01 Serisi için)



KOD NO	gr	mm		FİYAT/TL
L01-H300	300	300	12	
L01-H500	500	320	12	
L01-H1000	1000	360	12	
L01-H1500	1500	380	6	
L01-H2000	2000	400	6	

L02 Serisi

Bombe Başlı Çekiçler



KOD NO	oz	gr	mm		FİYAT/TL
L02-08	8	227	300	6	
L02-12	12	340	325	6	
L02-16	16	450	350	6	
L02-24	24	700	375	6	
L02-32	32	910	400	6	

L02F-12

Bombe Başlı Çekiç (Fiberglas Saplı)



KOD NO	oz	gr	mm		FİYAT/TL
L02F-12	12	340	315	6	

L07F-16

Çatal Çekiç (Fiberglas Saplı)



KOD NO	Oz-gr	mm		FİYAT/TL
L07F-16	16-450	335	6	

L12DB Serisi

Geri Tepmesiz Plastik Çekiçler



KOD NO	mm	gr	mm		FİYAT/TL
L12DB-35	35	450	290	10	
L12DB-45	45	675	305	10	
L12DB-50	50	900	325	8	

L12 Serisi

Plastik Kafalı Çekiçler



KOD NO	mm	mm		FİYAT/TL
L12-30	30	280	6	
L12-40	40	300	6	
L12-50	50	340	6	



Yedek Plastik Kafalar (L12 Serisi için) - Tek

KOD NO	mm	M		FİYAT/TL
L12-R30	30	M12	6•	
L12-R40	40	M16	6•	
L12-R50S	50	M20	6•	

L12C-35

Kombi Çekiç (Çelik ve Plastik Kafa) - 35 mm

yeni



KOD NO	mm	mm		FİYAT/TL
L12C-35	35	295	6	



Yedek Plastik Kafa (L12C-35 için)

KOD NO	mm		FİYAT/TL
L12C-35R	35	6•	

L16 Serisi

Lastik Tokmaklar



KOD NO	Ø mm	mm	mm	FİYAT/TL
L16-30	55	300	6	
L16-40	60	310	6	
L16-50	65	315	6	

L17-40

Alüminyum Çekiç



KOD NO	Ø mm	mm	mm	FİYAT/TL
L17-40	40	300	6	

L18 Serisi

Bakır Çekiçler



KOD NO	gr	mm	mm	FİYAT/TL
L18-750	750	320	6	
L18-1000	1000	350	6	
L18-1500	1500	360	6	

L25-2 Serisi

Düz Kesimler



KOD NO	mm	mm	mm	FİYAT/TL
L25-150-2	150	18	12	
L25-200-2	200	24	12	
L25-250-2	250	28	6	
L25-300-2	300	30	6	

L25-G-2 Serisi

Plastik Korunmalı Düz Kesimler



KOD NO	mm	mm	mm	FİYAT/TL
L25-250G-2	250	28	6	
L25-300G-2	300	30	6	

L27 Serisi

Düz Kesimler (Tesviyecisi Tipi)



KOD NO	mm	mm	mm	FİYAT/TL
L27-125	125	12	12	
L27-150	150	16	12	
L27-175	175	20	12	

L28 Serisi

Tırnak Kesimler



KOD NO	mm	mm	mm	FİYAT/TL
L28-125	125	5	12	
L28-150	150	7	12	

L29 Serisi

Nokta Zımbalar



KOD NO	Ø mm	mm	mm	FİYAT/TL
L29-3	3	100	12	
L29-4	4	120	12	
L29-5	5	150	12	

L29AT

Otomatik Nokta Zımba



KOD NO	Ø mm	mm	mm	FİYAT/TL
L29AT	3	150	20	
L29ATR	Yedek uç (L29AT için)		25	

L30 Serisi

Konik Pim Zımba



KOD NO	Ø mm	mm	mm	FİYAT/TL
L30-2	2	120	12	
L30-3	3	120	12	
L30-4	4	120	12	
L30-5	5	120	12	
L30-6	6	120	12	

L31 Serisi

Düz Pim Zımbalar



KOD NO	Ø mm	mm	mm	FİYAT/TL
L31-2	2	150	12	
L31-3	3	150	12	
L31-4	4	150	12	
L31-5	5	150	12	
L31-6	6	150	12	
L31-8	8	150	12	
L31-10	10	150	12	

L35-61

6 Parça Keski ve Zımba Takımı



KOD NO	mm	FİYAT/TL
L35-61	10	
L27 125, 150 mm		
L28 125 mm		
L29 4 mm		
L30 3 mm		
L31 4 mm		

L35-62

6 Parça Düz Pim Zımba Takımı



KOD NO	mm	FİYAT/TL
L35-62	10	
L31 2, 3, 4, 5, 6, 8 mm		

11 Çekiç ve Keski

L35A-51

5 Parça Keski ve Zimba Takımı - SAE

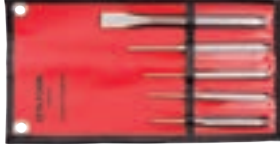

KOD NO		FİYAT/TL
L35A-51	1	

L27A 5/8 x 6-3/4 inch
L29A 1/8 x 4-7/8 inch
L30A 1/8 x 5-1/8 inch
L31A 2 PC: 1/8 x 5-3/16, 3/16 x 5-7/8 inch

L35A-11

11 Parça Keski ve Zimba Takımı - SAE



KOD NO		FİYAT/TL
L35A-11	1	

L27A 3 PC: 3/8 x 5-1/2, 1/2 x 6, 5/8 x 6-3/4 inch
L29A 3/16 x 6 inch L30A 3 PC: 3/32 x 5-1/4, 5/32 x 6, 3/16 x 6-1/4 inch
L31A 3 PC: 3/32 x 4-7/32, 5/32 x 5, 3/16 x 5-7/8 inch
Ölçüm aparatı 2-5/8 inch

L20-04SW

Kompakt Levye (Kıvrık Uçlu)



KOD NO	mm		FİYAT/TL
L20-04SW	180	6	

L20-0401

Keçe Levyesi - Düz



KOD NO	mm		FİYAT/TL
L20-0401	400	6	

L20-0403

Keçe Levyesi - Topuklu



KOD NO	mm		FİYAT/TL
L20-0403	400	6	

L20-120

Sökü Manivelası

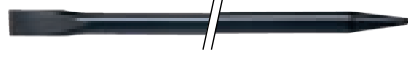

KOD NO	cm	mm		FİYAT/TL
L20-120	120	30	1	

L40P Serisi

Kayış Zimba Ağızları (L40G ile Kullanım)



KOD NO	Ø mm	Ø	mm		FİYAT/TL
L40P-03	3	1/8	25	6	
L40P-04	4	5/32	25	6	
L40P-05	5	3/16	25	6	
L40P-06	6	1/4	25	6	
L40P-08	8	5/16	25	6	
L40P-10	10	3/8	25	6	
L40P-12	12	15/32	25	6	
L40P-14	14	35/64	25	6	
L40P-16	16	5/8	25	6	
L40P-18	18	45/64	25	6	
L40P-20	20	25/32	25	6	
L40P-22	22	7/8	25	6	
L40P-25	25	1	25	6	
L40P-30	30	1 3/16	25	6	

L40G

Kayış Zimba Kolu (L40P Serisi ile Kullanım)



KOD NO	mm		FİYAT/TL
L40G	145	6	

L40-P14

14 Parça Değiştirilebilir Ağızlı Kayış Zimba Takımı

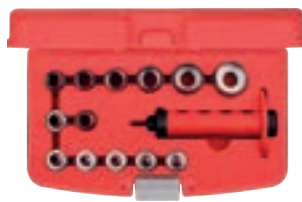

KOD NO		FİYAT/TL
L40-P14	1	

L40P 14 PC: 3, 4, 5, 6, 8, 10, 12, 14, 16, 18, 20, 22, 30 mm + L40G

L50-2 Serisi

Düz Iskarpelalar (Plastik Saplı)



KOD NO	mm	mm		FİYAT/TL
L50-06-2	6	140	10	
L50-08-2	8	140	10	
L50-10-2	10	140	10	
L50-12-2	12	140	10	
L50-14-2	14	140	10	
L50-16-2	16	140	10	
L50-18-2	18	140	10	
L50-20-2	20	140	10	
L50-22-2	22	140	10	
L50-25-2	25	140	10	
L50-30-2	30	140	10	

L50-B4-2

4 Parça Plastik Saplı Iskarpela Takımı



KOD NO		FİYAT/TL
L50-B4-2	1	

4 PC: L50-2 6, 12, 20, 25 mm

L50-W6-2

6 Parça Plastik Saplı Iskarpela Takımı (Ahşap Kutulu)



KOD NO		FİYAT/TL
L50-W6-2	1	

6 PC: L50-2 6, 10, 12, 16, 20, 25 mm

12 Özel Otomotiv Aletleri

143 | 161



N11-02A

Kompresyon Ölçüm Kiti (Benzinli Araçlar için)



ÇANTA GxYxD (mm)
235 x 145 x 50

Benzinli araçlarda kompresyon ölçümü yapmak için kullanılır, 150 mm uzunluğunda kaplinli adaptör ve 350 mm uzunluğunda 14/18 mm vida adaptörlü hortum tipi adaptörle sunulur

KOD NO	KAPASİTE psi / kPa	📦	FİYAT/TL
N11-02A	0-300 / 0-2000	1	
N11-02A/4		1	

N11-02A-2

Kompresyon Ölçüm Kiti (Benzinli ve LPG'li Araçlar için)

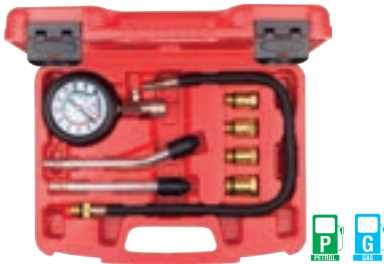

ÇANTA GxYxD (mm)
280 x 220 x 60

Benzinli ve LPG'li araçlarda kompresyon ölçümü yapmak için kullanılır, 130 mm uzunluğunda eğik ve düz 2 adet adaptör, 300 mm uzunluğunda 1 adet uzatma ve 10, 12, 14 ve 18 mm adaptörler içerir

KOD NO	KAPASİTE psi / kPa	📦	FİYAT/TL
N11-02A-2	0-300 / 0-2000	1	

N11-02B-2

Kompresyon Ölçüm Kiti (Dizel Araçlar için)

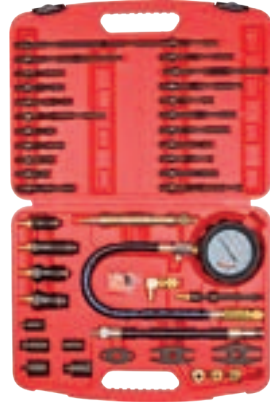

ÇANTA GxYxD (mm)
390 x 300 x 80

Dizel araçlarda kompresyon ölçümü yapmak için kullanılır, zengin enjektör ve kızdırma bujisi adaptör içeriği, yüksek kaliteli ölçüm saati.

KOD NO	KAPASİTE bar/psi	📦	FİYAT/TL
N11-02B-2	70/1000	1	

N11-03

Vakum ve Basınç Test Kiti



ÇANTA GxYxD (mm)
390 x 300 x 80

Yakıt, ateşleme, aktarma organları ve klima sistemi dahil aracın çeşitli yerlerindeki problemleri tespit etmeye yardımcı olur, ayrıca fren ve debriyaj sisteminde sıvı değişimi için parçalar içerir

KOD NO	KAPASİTE bar	📦	FİYAT/TL
N11-03	(-1) - 4	1	

N11-04

Yağ Basıncı Test Kiti

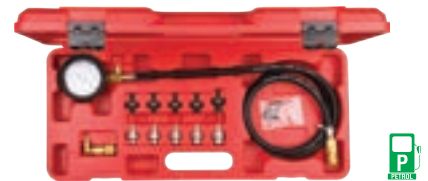

ÇANTA GxYxD (mm)
510 x 230 x 70

Yakıt pompası basıncının ve düşük yağ uyarı sistemlerinin kontrolü için kullanılır, kaplinli adaptörler ve 1.3 m uzunluğunda hortum içerir

KOD NO	KAPASİTE bar/psi	📦	FİYAT/TL
N11-04	0-10 bar / 0-150 psi	1	

CETA FORM
QUALITY

12 Özel Otomotiv Aletleri

N11-05

Dizel Enjektör Akış Test Kiti (Common Rail)

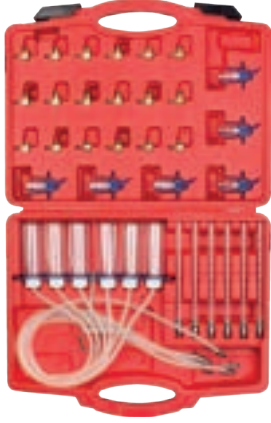

ÇANTA GxYxD (mm)
390 x 300 x 75

6 Silindire kadar common rail enjeksiyon sistemiyle çalışan dizel araçlarda geri dönen yakıt akışını ölçmeye yarar, yıpranmış ve hasar görmüş enjektörleri kolayca tespit eder, içeriğinde hızlı ölçüm için şişeler yer almaktadır

Bosch, Delphi, Denso sistemler için adaptörler sete ilave edilmiştir

KOD NO	ÇANTA	FİYAT/TL
N11-05	1	

N11-06

Yakıt Enjeksiyon Basıncı Test Kiti (Benzinli Araçlar için)

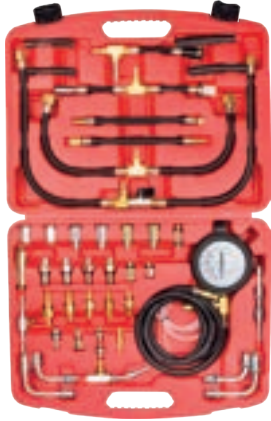

ÇANTA GxYxD (mm)
450 x 340 x 90

Benzinli araçlardaki yakıt sistem basıncını ölçmek için kullanılır, gerekli tüm adaptör, hortum ve fittingleri içerir, uzun tahliye hortumlu basınç valfi yakıtın güvenli tahliyesini sağlar

KOD NO	KAPASİTE bar/psi	ÇANTA	FİYAT/TL
N11-06	0-10 bar / 0-140 psi	1	

N11-20

Mekanikçi Steteskopu



Motordan gelen seslerin kaynağını (zarar görmüş pistonlar, supaplar vs.) tespit etmek için kullanılır, plastik kulaklıklar, 80 mm sabit, 210 mm ilave edilebilir sonda ucu

KOD NO	ÇANTA	FİYAT/TL
N11-20	1	

N12-01

Soğutma Sistemi Basınç Test Kiti



ÇANTA GxYxD (mm)
610 x 500 x 120

Araçlarda soğutma sistemi basıncı ölçümü için kullanılır, içeriğindeki çeşitli adaptörler sayesinde birçok araca uygundur **Güncellenen içerik: Artık daha fazla model kapsamaktadır**

KOD NO	ÇANTA	FİYAT/TL
N12-01	1	

N12-01B

Soğutma Sistemi Basınç Test Kiti (Universal Adaptörler ile)

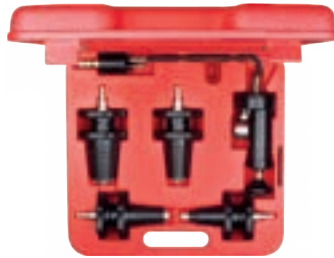

ÇANTA GxYxD (mm)
400 x 370 x 80

Araçlarda soğutma sistemi basıncı ölçümü için kullanılır, içeriğinde bulunan konik adaptörler hem vidalı hem de vidasız radyatör kapak yuvalarına uygundur

KOD NO	ÇANTA	FİYAT/TL
N12-01B	1	

N12-04AB

Refraktometre (AdBlue® Uyumlu)



ÇANTA GxYxD (mm)
200 x 75 x 55

4 ölçüm bir arada:

- Radyatör soğutma sıvısı (antifriz)
- Akü asidi
- Cam suyu antifrizi
- AdBlue® katkı maddesi

Soğutucu olarak etilen glikol, şarj sıvısı olarak da sülfürik asit (akü asidi) kullanan otomobil, kamyon, traktör, çekici ve gemi gibi taşıtlarda kullanılır

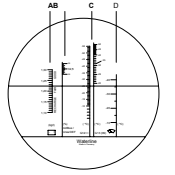

KOD NO	ARALIK mm	ÇANTA	FİYAT/TL
N12-04AB	150	1	

N12-05P

Antifriz Bomesi (Depolu)



Büyük ve okunması kolay skala, hidro statik sıvı kilidi, sıcaklık dengeleme özellikli iğz rotorlu ölçüm ünitesi, kabarcık oluşumunu önleyen giriş kanalı

KOD NO	ARALIK °C	ÇANTA	FİYAT/TL
N12-05P	0 / -40	1	

N12-05

Antifriz Bomesi



Radyatör içerisindeki etilen glikol (antifriz) yoğunluğunu ölçmek için kullanılır, tüp şeklinde kırılmaz kompozit gövde, kolay okunur skala

KOD NO	ARALIK mm	ÇANTA	FİYAT/TL
N12-05	200	10	

N12-10

Hortum Kelepçe Pensesi (Yaylı Kelepçeler için)



Hortum kelepçelerinin sökülmesi ve takılmasında kullanılır, yaylı tip kelepçeler için

KOD NO	mm		FİYAT/TL
N12-10	220	6	

N12-10L

Spiralli Hortum Kelepçe Pensesi (Yaylı Kelepçeler için)



Hortum kelepçelerinin sökülmesi ve takılmasında kullanılır, yaylı tip kelepçeler için, ulaşılması zor yerler için spiral şaftlıdır (680 mm)

KOD NO	mm		FİYAT/TL
N12-10L	230	12	

N12-12

Hortum Kelepçe Pensesi (Kulaklı Kelepçeler için)



Yakıt, soğutma sistemleri ve vakum hortumlarında kullanılan kulaklı tip kelepçeler için

KOD NO	mm		FİYAT/TL
N12-12	230	10	

N12-12HD

Aks Körük Kelepçe Pensesi (Torklu Sıkıştırmaya Uygun)

10
3/8"

Aks körüklerinde bulunan kelepçelerin belirtilen tork değerinde sıkılması için, alüminyum alaşımlı dayanıklı ve hafif gövde, çelik tutucu çeneler

KOD NO	mm		FİYAT/TL
N12-12HD	265	1	

N12-13

Hortum Kelepçe Pensesi (CLIC tip Kelepçeler için)



CLIC ve CLIC-R tipi tekrar kullanılabilen hortum kelepçeleri için

KOD NO	mm		FİYAT/TL
N12-13	180	6	

N12-10HEN

Hortum Kelepçe Aparatı (HENN Tip Kelepçeler için)



180° ayarlanabilir çene

Soğutucu hortumlar, turbo hortumlar gibi bölümlerde kullanılan HENN tipi kelepçelerin sökülmesinde kullanılır

KOD NO	mm		FİYAT/TL
N12-10HEN	100	1	

N12-P16 Serisi

Akış Kesici Plastik Penseler

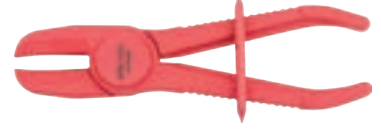

Esnek hortumları sıkıştırarak sıvı akışını engeller, yüksek kaliteli plastik malzeme, kilitleme halkası

KOD NO	mm	max. mm		FİYAT/TL
N12-P1615	155	15	12	
N12-P1630	185	30	12	
N12-P1660	250	52	12	

N12-P16KIT

3 Parça Akış Kesici Plastik Pense Seti

yeni



KOD NO		FİYAT/TL
N12-P16KIT	1	
3 PC: Ø15, Ø30, Ø52 mm		

N12-1625

Hortum Kelepçesi



Yakıt akışını geçici olarak durdurmak için kullanılır

KOD NO	mm		FİYAT/TL
N12-1625	25	1	

N12-25AT

3 Kollu Ayarlanabilir Yakıt Tankı Sensör Anahtarı



Plastik yakıt tankı sensör modüllerinin parçaya zarar vermeden sökülmesini sağlar, 3 kollu otomatik ayarlı tasarım

KOD NO	KAPASİTE mm	mm		FİYAT/TL
N12-25AT	89-170	16	1	

12 Özel Otomotiv Aletleri

C17-R Serisi

3/8" 6 Köşe Buji Lokmaları (Contalı)



10
3/8"

Ateşleme bujileri için, lastik tutucu contalar

KOD NO	Ømm	mm		FİYAT/TL
C17-R16	16	63	12•	
C17-R18	18	63	12•	
C17-R21	21	65	12•	
			Kart Bedeli	6



Teşhir kartlı sipariş için = Ürün Kodu + X

C17-R14C

3/8" 12 Köşe (Yıldız) Buji Lokması (İnce Cıdarlı)



10
3/8"

14 mm ateşleme bujileri için, tutucu metal klipsli

12 köşe ağız yapısı ile hem 6 köşe hem 12 köşe bujiler için

KOD NO	Ømm	mm		FİYAT/TL
C17-R14C	14	63	6•	
			Kart Bedeli	6



Teşhir kartlı sipariş için = Ürün Kodu + X

C17-R14ML

3/8" 12 Köşe (Yıldız) Buji Lokması (Mıknatıslı - Ekstra Uzun)



10
3/8"

14 mm ateşleme bujileri için, mıknatıslı tutma özelliği

12 köşe ağız yapısı ile hem 6 köşe hem 12 köşe bujiler için

KOD NO	Ømm	mm		FİYAT/TL
C17-R14ML	14	250	6	
			Kart Bedeli	6



Teşhir kartlı sipariş için = Ürün Kodu + X

C17-R14CF

3/8" 12 Köşe (Yıldız) Mafsallı Buji Lokması



10
3/8"

14 mm ateşleme bujileri için, mafsallı gövde, mıknatıslı tutma özelliği
12 köşe ağız yapısı ile hem 6 köşe hem 12 köşe bujiler için

KOD NO	Ømm	mm		FİYAT/TL
C17-R14CF	14	98	6	
			Kart Bedeli	6



Teşhir kartlı sipariş için = Ürün Kodu + X

C27-R Serisi

1/2" 6 Köşe Buji Lokmaları (Contalı)



12.5
1/2"

Ateşleme bujileri için, lastik tutucu contalar

KOD NO	Ømm	mm		FİYAT/TL
C27-R16	16	67	12•	
C27-R21	21	67	12•	
			Kart Bedeli	6



Teşhir kartlı sipariş için = Ürün Kodu + X

C27-RM Serisi

1/2" 6 Köşe Buji Lokmaları (Mıknatıslı)



12.5
1/2"

Ateşleme bujileri için, mıknatıslı tutma özelliği

KOD NO	Ømm	mm		FİYAT/TL
C27-R16M	16	67	6•	
C27-R21M	21	67	6•	
			Kart Bedeli	6



Teşhir kartlı sipariş için = Ürün Kodu + X

B32-S Serisi

T Saplı Oynar Başlı Buji Lokma Anahtarları (Mıknatıslı)



Ateşleme bujileri için, uzun sap boyu ve mafsallı özelliği ile derin ve ulaşılması zor yerlerde rahat kullanım, mıknatıslı tutma özelliği, 6 köşe

KOD NO	Ømm	mm		FİYAT/TL
B32-16S	16	510	6	
B32-21S	21	510	6	

N13-PC14

Buji Pensesi (Eğik Uzun Ağızlı)



Derin yataklı motorlardaki ateşleme bujilerinin sökülmesi içindir

KOD NO	MIN. mm	mm		FİYAT/TL
N13-PC14	14	290	6	

N13-10P03

3 Parça 3/8" Kızdırma Bujisi Lokma Takımı



10
3/8"

Tüm popüler kızdırma bujilerinin sökülme ve takılmasına uygun, 72 mm derinlikte, özel mafsallı lokmalar

KOD NO		FİYAT/TL
N13-10P03	10	

3 PC: 8, 10, 12 mm

N14-01 Serisi

Tas Tipi Yağ Filtre Anahtarları

10
3/8" ✓

Tas tipi, yağ filtrelerinin yuvalarına zarar vermeden sökülmesini sağlar, dar alanlar için ince profilli tasarım

Max. tork 115 Nm (85 lbf. ft)

N14-016514	LAND ROVER, Japon Arabaları
N14-016606	FIAT
N14-017612	FORD, PEUGEOT, RENAULT
N14-017614	BMW, MERCEDES, PORSCHE, VW, AUDI, SEAT
N14-018616	BMW, VOLVO
N14-019515	FORD: Transit van

KOD NO	Ø mm	Kanal	📦	FİYAT/TL
N14-016514	65	14	12	
N14-016606	66	6	12	
N14-017612	76	12	12	
N14-017614	76	14	12	
N14-018616	86	16	12	
N14-019515	95	15	12	

N14-01S Serisi

Lokma Tipi Yağ Filtre Anahtarları

10
3/8" ✓

Çelik kartuş filtrelerde kullanmak için ince profil tasarım

N14-01S32	OPEL Astra-G/Corsa-B/Zafira
N14-01S36	BMW 24V, FORD DuraTorq dizel / Transit, MERCEDES 116 MB Vito Cdi, OPEL 16V

KOD NO	Ø mm	📦	FİYAT/TL
N14-01S32	32	12	
N14-01S36	36	6	

N14-02 Serisi

Tas Tipi Yağ Filtre Anahtarları (Alüminyum)

12.5
1/2" ✓

Tas tipi, yağ filtre yuvalarına zarar verme riskini minimuma indirmek için alüminyum gövde, dar alanlar için ince profilli tasarım

N14-027414	AUDI, BMW, MERCEDES, VW
N14-029215	ALFA-ROMEO, AUDI, CHRYSLER, FORD, HONDA, MAN, MITSUBISHI, NISSAN, OPEL/VAUXHALL, PORCHE, RENAULT, VOLVO, VW (Özellikle KNECHT ve MAHLE filtreler için kullanılır)

KOD NO	Ø mm	Kanal	📦	FİYAT/TL
N14-027414	74	14	12	
N14-029215	92	15	12	

N14-01K09

9 Parça Tas Tipi Yağ Filtre Anahtar Takımı (Avrupa Araçlar İçin)

ÇANTA GxYxD (mm)
330 X 260 X 70

Piyasadaki çoğu Avrupa araçlar için uygun filtre anahtar takımı, 3/8" sürücülü, D1/2"-E3/8" adaptör ile sunulur

KOD NO	📦	FİYAT/TL
N14-01K09	1	

**N14-01**
Ø mm 66 (6 Kanal), 76 (12 Kanal), 76 (14 Kanal), 86 (16 Kanal)**N14-01S**
Ø mm 76 (6 Kanal), 36 (6 Kanal)**N14-02**
Ø mm 74 (14 Kanal), 92 (15 Kanal)**C21-91S** D1/2" - E3/8"**N14-03 Serisi**

Zincirli Yağ Filtre Anahtarları



Çift zincir sayesinde güvenli ve yüksek sıkıştırma kuvveti, oynar mafsal, özel alet çeliği gövde

KOD NO	Ø mm	mm	📦	FİYAT/TL
N14-031	60-110	230	1	
N14-032	60-160	230	1	
N14-033	60-195	230	1	

N14-03SQ Serisi

Zincirli Yağ Filtre Anahtarları (1/2" Kareli)

12.5
1/2" ✓

Çift zincir sayesinde güvenli ve yüksek sıkıştırma kuvveti, 1/2" kareli lokma aksesuarları ile kullanılır

KOD NO	Ø mm	📦	FİYAT/TL
N14-031SQ	60-110	1	
N14-032SQ	70-170	1	

N14-04S Serisi

Metal Bantlı Yağ Filtre Anahtarları (Döner Kafa)



Döner mafsal sayesinde dar alanlarda çalışma kolaylığı, metal bant yüzeyinde filtrenin kaymasını önleyen dokulu bölgeler

KOD NO	Ø mm	mm	📦	FİYAT/TL
N14-04S1	70-82.5	200	6	
N14-04S2	87-95	200	6	
N14-04S3	95-110	200	6	

N14-05 Serisi

Kayışlı Yağ Filtre Anahtarları

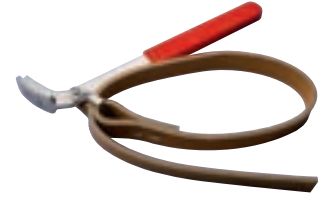

Kaydırma yapmayan sağlam kayış

KOD NO	Ø max mm	mm	📦	FİYAT/TL
N14-051	160	225	6	
N14-052	200	225	6	

N14-05R Serisi

Yedek Kayışlar (N14-05 Serisi için)



KOD NO	📦	FİYAT/TL
N14-051R	N14-051	1
N14-052R	N14-052	1

N14-061S

Metal Bantlı Yağ Filtre Anahtarı (Ergo Sap)



Yüksek dayanımlı kaymaz yüzeyli metal bant, dayanıklı plastikten üretilmiş ergonomik sap

KOD NO	Ø mm	mm	📦	FİYAT/TL
N14-061S	60-100	155	6	



Yedek Metal Bant (N14-06 Serisi için)

KOD NO	Ø mm	mm	📦	FİYAT/TL
N14-06R	N14-061S, N14-06	10	•	

12 Özel Otomotiv Aletleri

N14-081

Ayarlı Yağ Filtre Pensesi



Kayar mafsal tasarım sayesinde hızlı ayar

KOD NO	Ø mm	mm	mm	FİYAT/TL
N14-081	60-100	300	6	

N14-071

3 Kollu Yağ Filtre Anahtarı



10 3/8"

Güç uygulandığında kapanan tırtır yüzeyli bacaklar, 3/8" sürücülü, 3/8"E-1/2"D adaptör ile sunulur

KOD NO	Ø mm	mm	FİYAT/TL
N14-071	65-120	1	

N14-072

3 Kollu Yağ Filtre Anahtarı (Ticari Araçlar için)

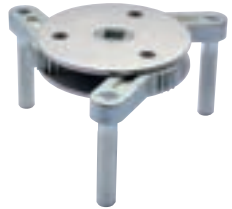

12.5 1/2"

Ticari araçlar için, hava kurutucu kartuşlar için de kullanılır, kendinden ayarlı mekanizma, güç uygulandığında kapanan tırtır yüzeyli bacaklar, 1/2" sürücülü

KOD NO	Ø mm	mm	FİYAT/TL
N14-072	95-165	1	

N14-07DSG1

1/2" Yağ Filtre Anahtarı, DSG Şanzıman Yağ Değişimi için (Kısa)



12.5 1/2"

Tüm özellikler N14-07DSG2 ile aynıdır, ancak ürün common rail motorlar için kısa tipte üretilmiştir

KOD NO	Ø mm	mm	FİYAT/TL
N14-07DSG1	24	100	1

N14-07DSG2

1/2" Yağ Filtre Anahtarı, DSG Şanzıman Yağ Değişimi için (Uzun)



12.5 1/2"

VW grubu araçlar için, DSG şanzımanlarda yağ filtre değişimi esnasında kapaklar için kullanılır, akü v.b. sökümü gerek bırakmaz ve yaklaşık yarım saat zaman tasarrufu sağlar

KOD NO	Ø mm	mm	FİYAT/TL
N14-07DSG2	24	140	1

N14-10

Karter Tapa Anahtarı



Dişi karter tapa somunlarının montajında ve sökülmesinde kullanılır

KOD NO	Ø mm	mm	FİYAT/TL
N14-10	8x10	285	6

N14-12S Serisi

3/8" Kare Uçlu Karter Tapa Lokmaları



10 3/8"

Dişi karter tapa somunlarının montajında ve sökülmesinde kullanılır

KOD NO	Ø mm	mm	FİYAT/TL
N14-12S08	8	36	1
N14-12S10	10	36	1
N14-12S12	12	36	1

N14-12X16

3/8" Delikli XZN Karter Tapa Lokması



10 3/8"

Özellikle vites kutusundaki yağ karter tapaları içindir

KOD NO	Ø mm	mm	FİYAT/TL
N14-12X16	M16	36	1

N14-12F10

3/8" Dişi Kare Karter Tapa Lokması



10 3/8"

Motor, vites kutusu ve diferansiyellerde kullanım içindir

KOD NO	Ø mm	mm	FİYAT/TL
N14-12F10	10	36	1

N14-12VAG.B

1/4" Karter Tapa Bits Uç - VAG Plastik Tapalar için



VAG grubu otomobillerde bulunan plastik karter tapalarının montajında ve sökülmesinde kullanılır

KOD NO	mm	FİYAT/TL
N14-12VAG.B	35 mm	1

N14-12P14

14 Parça 3/8" Karter Tapa Anahtar Takımı



10 3/8"

KOD NO	FİYAT/TL
N14-12P14	1

○ N14-12S 8, 10, 12 mm	⊗ N14-12X16 M16
○ N14-12H 8, 10, 12, 14, 17 mm	⊗ N14-12T45 T45
○ N14-12F10 10 mm	⊗ N14-12TR9
N14-12VAG.B	C11-37 3/8"x250 mm

N14-12R09

9 Parça 3/8" Karter Tapa Anahtar Takımı

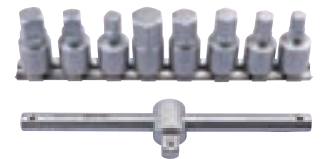

10 3/8"

KOD NO	FİYAT/TL
N14-12R09	1

○ N14-12S 8, 10, 12 mm	C11-40 3/8"x200 mm
○ N14-12H 8, 10, 12, 14, 17 mm	

N15-T1PE

Üniversal Kasnak Çektirme

10
3/8"

Krank mili, ana ve yardımcı kasnakları çıkarmak için, dişli kasnakları da kavramaya imkan veren çeneler, dar alanlar için ince profilli tasarım

KOD NO				FİYAT/TL
N15-T1PE	45-175	19	1	

N15-T2UNI

Triger Kasnağı Çevirme Aleti



Triger kasnağı üzerinde bulunan bağlantı elemanlarını söküp takarken kasnağın sabit tutulması için kullanılır

KOD NO				FİYAT/TL
N15-T2UNI	60-220	400	10	

N15-T3UNI

Triger Kayışı Gergi Rulmanı Kilitleme Pim Takımı



Triger kayışının değişimi esnasında eksantrik kasnağının kilitlenmesi için kullanılır, 6 değişik çapta pim

KOD NO		FİYAT/TL
N15-T3UNI	1	
6 PC: 0.79mm / .0310", 1.24mm / .0490", 1.37mm / .0540", 1.49mm / .0585", 1.68mm / .0660", 1.92mm / .0760"		

N15-K1VAG

Sente Aparatı Takımı

(VAG 1.2D, 1.4D, 1.6D, 1.9D, 2.0D Tdi PD/CR)

**Uygulama:**

Audi: A1, A3, A4, A5, A6, Q5, TT / **Seat:** Alhambra, Altea, Cordoba, Ibiza, Leon, Toledo / **Skoda:** Fabia, Fabia II, Octavia, Octavia II, Roomster, Superb, Superb II, Yeti / **VW:** Amarok, Beetle, Bora, Caddy, EOS, Fox, Golf, Jetta, Lupo, Passat/CC, Polo, Scirocco, Sharan, Tiguan, Touran, Transporter / **Dodge:** Caliber / **Ford:** Galaxy / **Mitsubishi:** Grandis, Lancer, Outlander

Motor Kodları:

VAG Pompe (Pompe Duse): AJM, AMF, ANU, ARL, ASZ, ATD, AUJ, AVB, AVF, AVQ, AWX, AXB, AXC, AXR, AZV, BAY, BDJ, BDK, BEW, BGW, BHC, BHW, BJB, BKC, BKD, BKE, BKP, BLB, BLS, BLT, BMA, BMM, BMN, BMP, BMR, BMS, BMT, BNA, BNM, BNV, BPW, BPX, BPZ, BRB, BRC, BRD, BRE, BRF, BRM, BRR, BRS, BRT, BRU, BSS, BST, BSU, BSV, BSW, BTB, BUK, BUY, BUZ, BVA, BVE, BVF, BVG, BVH, BVK, BWB, BWV, BXE, BXF, BXJ

VAG (Common Rail): CAAA, CAAB, CAAC, CAAE, CAGA, CAGB, CAGC, CAHA, CAHB, CAYA, CAYB, CAYC, CAYD, CAYE, CBAA, CBAB, CBAC, CBBA, CBBB, CBDA, CBDB, CBDC, CBEA, CCHA, CCHB, CDBA, CDCA, CEGA, CFCA, CFFA, CFFB, CFFG, CFHA, CFHB, CFHC, CFHE, CFHF, CFJA, CFWA, CGLA, CGLB, CJAA, CJCA, CJCB, CLCA, CLCB, CLJA, CLNA, CMEA

Dodge: ECD**Ford:** ANU, ASZ, AUJ**Mitsubishi:** BWC, BSY

KOD NO		FİYAT/TL
N15-K1VAG	1	

N15-K2VAG.U

Sente Aparatı Takımı (VW/Audi 1.2/1.4 TFSI - 1.4/1.6 FSI)

**Uygulama:**

Audi: A1, A3 / **Seat:** Altea, Cordoba, Ibiza, Leon, Toledo / **Skoda:** Fabia II, Octavia II, Roomster, Super II, Yeti / **VW:** Caddy, Eos, Golf, Jetta, Passat, Polo, Scirocco, Tiguan, Touran

Motor Kodları:

AXU, BAG, BKG, BLN, BLF, BLG, BLP, BMY, BTS, BWK, CAVA, CAVB, CAVC, CAVD, CAVE, CAVF, CAXA, CAXC, CBZA, CBZB, CBZC, CDGA, CSMa

KOD NO		FİYAT/TL
N15-K2VAG.U	1	

N15-K2VAG.12

Sente Aparatı Takımı (VAG 1.2 TSI)

**Uygulama:**

Audi: A1, A3 / **Seat:** Altea, Ibiza, Leon, Toledo / **Skoda:** Fabia II, Octavia II, Praktik, Rapid, Roomster, Yeti / **VW:** Beetle, Caddy, Golf Plus, Golf VI, Jetta, Polo, Touran

Motor Kodları: CBZA, CBZB, CBZC

KOD NO		FİYAT/TL
N15-K2VAG.12	1	

N15-K3VAG

Sente Aparatı Takımı

(VW/Seat/Skoda 1.2 6/12V)

**Uygulama:**

Seat: Cordoba, Ibiza / **Skoda:** Fabia, Fabia II, Roomster / **VW:** Fox, Polo

Motor Kodları:

AWY, AZQ, BBM, BMD, BME, BXV, BZG, CEVA, CGPA, CGPB, CHFA, CHFB, CJLA

KOD NO		FİYAT/TL
N15-K3VAG	1	

N15-K4VAG

Sente Aparatı Takımı (VAG 1.0/1.2/1.4 TSI)

**Uygulama:**

VW Golf VII 2012+ / Jetta 2012+ / Santana/Gran/Lavida

Motor Kodları:

EA211 1.0MPI 1.2TST 1.4MPI 1.4TSI

KOD NO		FİYAT/TL
N15-K4VAG	1	

12 Özel Otomotiv Aletleri

N15-M1VAG

Master Sente Aparatı Takımı (VAG)

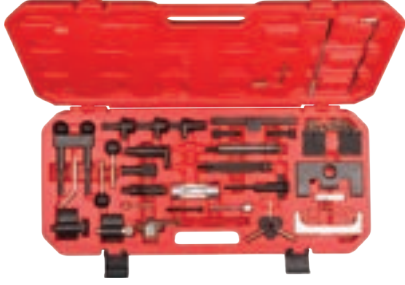

ÇANTA GxYxD (mm)
600 x 270 x 60



VW grubu benzinli ve dizel araçlarda triger kayışı / zinciri değişimi için komple takım

Uygulama:

1.2 6V/12V, 1.4, 1.6, 1.8, 1.8T, 2.0 16 V benzinli motorlar
1.4, 1.9, 2.0TDI dizel motorlar

KOD NO



FİYAT/TL

N15-M1VAG

1

N15-T1BMW

Enjeksiyon Pompa Çektirmesi (BMW 1.8, 2.0, 3.0D)



Pompa dişlisini çıkarırken yakıt pompasının güvenli çıkartılması ve pompa motordan ayrılırken pompa dişlisinin pozisyonunu korumak için

Uygulama:

BMW 318d, 320d (E46) 1988-2005 arası / 318td, 320td, 525d, 530d, 530, 535 (E60-61) 2000-2006 arası araçlarda bulunan M47, M47T2, M47TU, M57, M57TU kodlu motorlar için dir

KOD NO



FİYAT/TL

N15-T1BMW

1

N15-K1BMW

Sente Aparatı Takımı (BMW 2.0, 3.0D N47/N57)



Uygulama:

116d, 118d, 120d, 123d, 316d, 318d, 320d, 325d, 330d/xd, 520d, 525d, 530d, 530d GT, 535d, 535d GT, 730d/Ld, 740d, 740d xDrive, X1 sDrive 1.8d/2.0d, X1 xDrive 1.8d/2.0d/2.3d, X3 2.0d, X3 xDrive 1.8d/3.0d, X5 3.0d, X5 xDrive 4.0d, X6 xDrive 3.0d/4.0d

Motor Kodları:

D20A, D20B, D20U0, D2000, D20T0, D30U0, D3000, D3001, D30T0

KOD NO



FİYAT/TL

N15-K1BMW

1

N15-K2BMW

Sente Aparatı Takımı (BMW/Mini 1.4, 1.6N13)



Citroen ve Peugeot modelleri için de uygundur, lütfen detaylı uygulama ve motor kodları listesini dikkate alın

Uygulama:

BMW, Mini

Motor Kodları:

N13, N16, N18,

KOD NO



FİYAT/TL

N15-K2BMW

1

N15-K3BMW

Sente Aparatı Takımı (BMW B38/B48/B58)

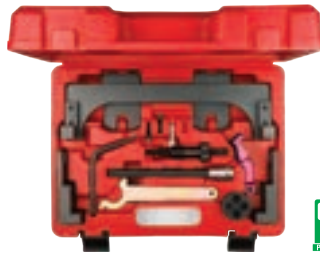

Eksantrik mili / değişken eksantrik mili zamanlama ünitesinin takılması ve çıkarılması için kullanılır

Uygulama:

BMW: 330e 2016-17 | 740e xDrive 2017-17 | i8 2015-17
Mini: Cooper 2015-17 | Cooper Countryman 2017

Motor Kodları:

BMW/Mini: B38, B48, B58

KOD NO



FİYAT/TL

N15-K3BMW

1

N15-K1FIA

Sente Aparatı Takımı

(FIAT 1.3 Multijet/OPEL 1.3 CDTI)



Suzuki ve Ford modelleri için de uygundur, lütfen detaylı uygulama ve motor kodları listesini dikkate alın

Uygulama:

Alfa Romeo: MiTo / **Fiat:** 500, Albea (TR), Doblo/Cargo, Fiorino, Grande Punto, Idea, Linea, Panda, Punt, Punto Evo, Qubo / **Ford:** Ka / **Lancia:** Musa, Ypsilon / **Suzuki:** Ignis, Splash, Swift, Wagon R+ / **Vauxhall/Opel:** Agila, Agila*B, Astra-H, Astra-J, Combo-C, Corsa-C, Corsa-D, Meriva-A, Meriva-B, Tigra-B

Motor Kodları:

Fiat Group: 169A1.000, 188A8.000, 188A9.000, 199A2.000, 199A3.000, 199A9.000, 199B1.000, 199B2.000, 223A9.000

Suzuki: D13A, Z13DT, Z13DTJ

Vauxhall/Opel: A13DTC, A13DTE, A13DTR, D13A, LDV/A13DTC, LSF/A13DTE, Y13DT, Y13DTH, Z13DT, Z13DTI, Z13DTH, Z13DTJ, Z13DTR

KOD NO



FİYAT/TL

N15-K1FIA

1

N15-K1FIA/3

1

N15-K3FIA

Sente Aparatı Takımı

(FIAT 1.6D, 1.9D, 2.0D, 2.4D JTD/MultiJet)



Uygulama:

Alfa Romeo: 145, 146, 147, 156, 159, 166, Brera, Crosswagon, Giulietta, GT, MiTo, Spider / **Fiat:** Brava/Bravo, Croma, Doblo/Cargo, Grande Punto, Idea, Linea, Marea/Weekend, Multipla, Palio Weekend, Punto, Punto Evo, Sedici, Stilo, Strada Pick-Up / **Lancia:** Delta, Kappa, Lybra, Musa, Thesis

Motor Kodları:

182B4.000, 182B9.000, 185A6.000, 186A6.000, 186A8.000, 186A9.000, 188A2.000, 188A7.000, 188B2.000, 192A1.000, 192A3.000, 192A5.000, 192A8.000, 192A9.000, 192B1.000, 192B4.000, 192B5.000, 198A2.000, 198A3.000, 198A6.000, 199A5.000, 223A7.000, 223B1.000, 323.02, 325.01, 342.02, 350A2.000, 350A3.000, 362.02, 371.01, 838A8.000, 839A5.000, 839A6.000, 841C.000, 841G.000, 841H.000, 841M.000, 844A1.000, 844A2.000, 937A2.000, 937A3.000, 937A4.000, 937A5.000, 937A6.000, 939A1.000, 939A2.000, 939A3.000, 939A7.000, 939A8.000, 939A9.000, 940A3.000, 940A4.000, 940A5.000, 955A3.000, 955A4.000, D19AA

KOD NO



FİYAT/TL

N15-K3FIA

1

N15-K2RENSente Aparatı Takımı
(RENAULT 1.4, 1.6, 1.8, 2.0 16V)yeni
tasarım**Uygulama:**

Renault: Avantime, Clio II, Clio III/Sport, Espace/Grand Espace, Kangoo/Trekka, Kangoo II/Be Bop, Laguna, Laguna II, Laguna III, Logan/MCV, Megane, Megane II, Megane III/Sport, Megane/Scenic, Modus/Grand Modus, Scenic/RX4, Scenic/Grand Scenic II, Trafic II, Twingo II/Sport /
Nissan: Kubistar, Primastar / **Vauxhall/Opel:** Vivaro

Motor Kodları:

K4J: 730, 732, 740
K4M: 708, 730, 732, 752, 753, 760, 761, 764, 812, 813
F4P: 720, 722, 760, 770, 771, 772, 773, 774, 775
F4R: 700, 701, 712, 713, 714, 715, 720, 722, 730, 732, 740, 741, 744, 746, 762, 763, 764, 765, 766, 767, 770, 771, 774, 776, 780, 784, 786, 787, 790, 791, 792, 794, 795, 796, 797, 800, 802, 810, 811, 820, 830, 832, 867, 870, 874, 886, 887, 896, 897

KOD NO		FİYAT/TL
N15-K2REN	1	

N15-T1RENEksantrik Mili Kasnağı Kilitleme Aparatı
(RENAULT 1.4, 1.6 16V)

Triger kayışının değiştirilmesi sırasında eksantrik mili kasnağı tutmak için, N15-K2REN setiyle birlikte kullanılır

Uygulama:

1.4, 1.6 16V benzinli motorlar

Motor Kodları:

K4J: 730, 732, 740
K4M: 708, 730, 732, 752, 753, 760, 761, 764, 812, 813

KOD NO		FİYAT/TL
N15-T1REN	1	

N15-K3REN

Sente Aparatı Takımı (RENAULT 2.2, 2.5 dCi)



Nissan ve Vauxhall/Opel modelleri için de uygundur, lütfen detaylı uygulama ve motor kodları listesini dikkate alın

Uygulama:

Renault: Espace, Master, Traffic / **Nissan:** Interstar, Primastar / **Vauxhall/Opel:** Movano, Vivaro

Motor Kodları:

G9U, G9T

KOD NO		FİYAT/TL
N15-K3REN	1	
N15-K3REN/3	1	

N15-M1REN

Master Sente Aparatı Takımı (RENAULT)

**ÇANTA GölyüD (mm)**

370 x 300 x 80

RENAULT Grubu benzinli ve dizel araçlarda triger kayışı / zinciri değişimi için komple aparat takımı

Uygulama:

1.2, 1.4, 1.6, 1.8, 2.0 16V, 2.5 20V benzinli motorlar
1.9 D/TD/dTi, 2.2 D/TD, 2.5D, 2.8 dTi dizel motorlar
1.5 dCi, 1.9 dCi, 2.2 dCi, 2.5 dCi dizel motorlar

KOD NO		FİYAT/TL
N15-M1REN	1	

N15-M1FRD

Master Sente Aparatı Takımı (FORD)

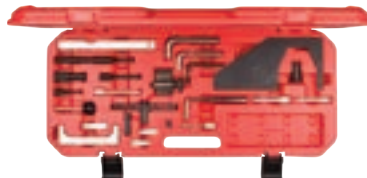
**ÇANTA GölyüD (mm)**

600 x 270 x 60

FORD Grubu benzinli ve dizel araçlarda triger kayışı / zinciri değişimi için komple aparat takımı

Uygulama:

1.25, 1.4, 1.6, 1.6 Ti-VCT, 1.8, 2.0 benzinli motorlar
1.4/1.6 TD/Ci, 1.8 D/TD/TDCi/TDDi, 2.0 TDCi dizel motorlar

KOD NO		FİYAT/TL
N15-M1FRD	1	

N16-0101

Supap Yayı Sıkıştırma Aleti



Supap değişimi esnasında motor supap yaylarının sıkıştırılmasında kullanılır, çoğu küçük ve orta ölçekli OHV motorlar için, otomatik kilitlemeli paralel kaldırır

KOD NO	KAPASİTE mm	mm		FİYAT/TL
N16-0101	75-225	300	1	

N16-06

13 Parça Silindir Servis Kiti

**ÇANTA GölyüD (mm)**

490 x 250 x 60

Üst motor için komple servis kiti, kafaları sökmeden valf yaylarının sökülmesinde kullanılır. 8, 16 ve 24 valfli motorlar için uygundur

KOD NO		FİYAT/TL
N16-06	1	

N16-07

Supap Keçe Pensesi



16V ve 24V OHC motorların supap keçelerinin sökülüp takılmasında kullanılır, oluklu çene, uzun tip ağız

KOD NO	mm		FİYAT/TL
N16-07	280	6	

N16-10 Serisi

Piston Segmanı Sıkıştırma Çemberleri



Pistonların silindirlere yerleştirilmesi esnasında piston segmanlarını sabit ve merkezde tutmaya yarar, özel yay çeliği, sıkma kolu ile birlikte verilir

KOD NO	mm	mm		FİYAT/TL
N16-1001	53-125	75	1	
N16-1002	53-175	75	1	
N16-1003	60-125	100	1	
N16-1004	60-175	100	1	
N16-1005	60-175	150	1	

12 Özel Otomotiv Aletleri

N16-11 Serisi

Piston Segman Penseleri (Yengeç Tipi)

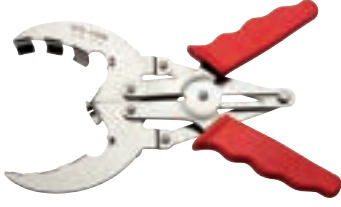

Piston segmanlarının takılması ve çıkarılması için

KOD NO	Ø mm	mm	mm	FİYAT/TL
N16-1110	50-100	215	1	
N16-1116	110-160	260	1	

N17-052208

1/2" Dizel Enjektör Lokması - 22 mm



Dizel enjektörlerin sökülmesi ve takılması için kullanılır

Uygulama:

Nissan, VW

KOD NO	Ø mm	mm	mm	FİYAT/TL
N17-052208	22	78	10	

N17-052211

1/2" Dizel Enjektör Lokması - 22 mm



Dizel enjektörlerin sökülmesi ve takılması için kullanılır

Uygulama:

Audi, BMW, Mercedes, Rover, Seat, Vauxhall/Opel, Volvo, VW

KOD NO	Ø mm	mm	mm	FİYAT/TL
N17-052211	22	110	10	

N17-052708

1/2" Dizel Enjektör Lokması - 27 mm



Dizel enjektörlerin sökülmesi ve takılması için kullanılır

Uygulama:

BMW, Fiat, Ford, Peugeot

KOD NO	Ø mm	mm	mm	FİYAT/TL
N17-052708	27	80	10	

N17-05L14

1/2" Enjektör Hattı Lokması - 14 mm



Enjektör hatlarında bulunan civatalı bağlantılar için kullanılır

Uygulama:

Fiat, Citroen, Peugeot, Renault, Iveco (Common Rail motorlar)
BMW, Mercedes-Benz, VW (civatalı enjektör hattı bağlantıları)

KOD NO	Ø mm	mm	mm	FİYAT/TL
N17-05L14	14	119	1	

N17-05L17

1/2" Enjektör Hattı Lokması - 17 mm



Enjektör hatlarında bulunan civatalı bağlantılar için kullanılır

Uygulama:

Mercedes-Benz 100, 130, 314, 360, 360h, 352A, 346/355, 401, 402, 403, 407h, 615, 616, 617

KOD NO	Ø mm	mm	mm	FİYAT/TL
N17-05L17	17	119	1	

N17-05L19

1/2" Enjektör Hattı Lokması - 19 mm



Enjektör hatlarında bulunan civatalı bağlantılar için kullanılır

Uygulama:

Mercedes-Benz 352 A, 346/355 A, 401, 402/422 LA, 403, 407h

KOD NO	Ø mm	mm	mm	FİYAT/TL
N17-05L19	19	119	1	

N18-1522S

3/8" Oksijen (Lambda) Sensör Lokması



Isıtmalı ve ısıtmasız oksijen sensörlerinin sökülüp takılmasında kullanılır, kablo yarıklı tasarım

KOD NO	Ø mm	mm	mm	FİYAT/TL
N18-1522S	22	90	10	

N18-1522SL

1/2" Açılı Oksijen (Lambda) Sensör Lokması



Isıtmalı ve ısıtmasız oksijen sensörlerinin sökülüp takılmasında kullanılır, açılı tasarım sensöre üst kısım yerine yan kısımdan erişim sağlar ve kablo hasarını önler

KOD NO	Ø mm	mm	FİYAT/TL
N18-1522SL	22	1	

N18-CC

Zincirli Egzoz Kesici



2.6 mm'ye kadar cidarlı çelik, bakır ve PVC boruların kesiminde kullanılır, egzoz borularının kesimi için özellikle önerilir, 13 bıçaklı keski zincir, epoksi kaplı, yüksek mukavemetli çelik sac sap

KOD NO	Ø mm	mm	mm	FİYAT/TL
N18-CC	15-75	250	1	



KOD NO	mm	FİYAT/TL
N18-CCR	N18-CC için	1

N21-0101

Fren Hidroliği Test Cihazı (8 Test)



Fren hidrolik sıvısı kalitesinin ölçümü için, renk kodlamalı diyot lambalar, otomobil, kamyon, motosiklet gibi tüm araçlarda kullanılır, 1 adet 1.5V AAA Pil (dahil)

Uygulama:

1: DOT 3, 2: DOT 4, 3: DOT 5.1, 4: ACD elco DOT 3, 5: PENNZOIL DOT 3, 6: Prestone DOT 3, 7: Motorcraft DOT 3, 8: TOYOTA DOT 3

KOD NO	mm	FİYAT/TL
N21-0101	155	10

N21-0102

Fren Hidroliği Test Cihazı



Fren hidrolik sıvısı kalitesinin ölçümü için, renk kodlamalı diyot lambalar, otomobil, kamyon, motosiklet gibi tüm araçlarda kullanılır, 1 adet 1.5V AAA Pil (dahil)

Uygulama: DOT 4

KOD NO	mm	FİYAT/TL
N21-0102	150	25

N21-0302

Fren Hidroliği Değişirme ve Hava Alma Takımı (Pnömatik)



Fren hidrolik sıvısının boşaltılması için, hava ile çalışır, ABS frenler için de uygundur, sabit ve hareketli ağızlı 2 adet takviye şişesi vardır

KOD NO	KAPASİTE litre		FİYAT/TL
N21-0302	0.75-1	1	

N21-04P12

12 Parça Fren Pistonu İtme Çevirme Kiti, Standart İçerik

yeni tasarım

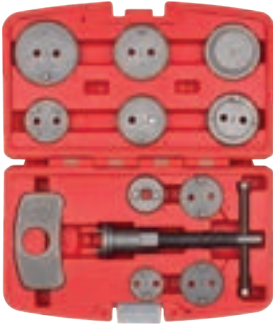

Yeni fren balatalarının montajı esnasında fren pistonlarının itilmesi / çevrilmesi için aparat takımı, piyasadaki çoğu araçlar için uygundur

KOD NO		FİYAT/TL
N21-04P12	1	

N21-04P21

21 Parça Fren Pistonu İtme Çevirme Kiti, Kapsamlı İçerik

yeni tasarım

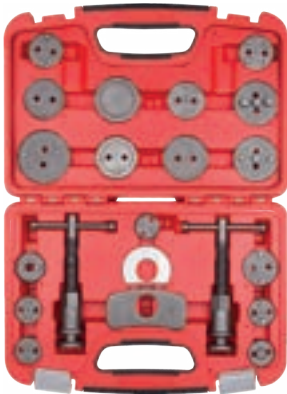

Yeni fren balatalarının montajı esnasında fren pistonlarının itilmesi / çevrilmesi için aparat takımı, piyasadaki çoğu araçlar için uygundur

KOD NO		FİYAT/TL
N21-04P21	1	

N21-20BC

Fren Diski Kalınlık Kumpası



Fren disk kalınlık ölçümü için, 0.1 mm okuma aralığı, metrik skala, plastik kutulu

KOD NO	KAPASİTE max.mm		FİYAT/TL
N21-20BC	60	1	

N21-20BCW

Fren Diski Kalınlık Kumpası / Monte Lastik Üzerinden



Lastik sökümüne gerek kalmadan fren disk kalınlık ölçümü için, müşteri nezaretinde ölçüm için ideal

KOD NO	KAPASİTE max.mm		FİYAT/TL
N21-20BCW	45	1	

N21-30DST

El Freni Teli Montaj Aleti



El freni balatalarına (arka disk) ait çekme telinin montajında ve sökülmesinde kullanılır

KOD NO	mm		FİYAT/TL
N21-30DST	155	6	

N21-05

Fren Pistonu - Disk Ayırıcı



Yeni fren balatalarının montajı esnasında pistonun geri çekilmesi için kullanılır

KOD NO	KAPASİTE mm		FİYAT/TL
N21-05	0-70	1	

N22-01K05

5 Parça Amortisör Yayı Sökme Kiti



McPherson helazon yaylarının güvenli ve kolay şekilde sökümünü sağlar, 1500 kg maksimum yük, 2 çift çene ile birlikte sunulur, piyasadaki çoğu araçlar için uygundur

KOD NO		FİYAT/TL
N22-01K05	1	

N22-0202

Amortisör Yayı Çektirme Takımı



Lastiğin iç kısmı gibi dar alanlarda çalışmaya imkan veren çene tasarımı, dövülmüş Krom Vanadyum çeliği çeneler, karşılıklı sağ-sol helis dişler sayesinde hızlı hareket

KOD NO	KAPASİTE mm	mm		FİYAT/TL
N22-0202	65-320	13	1	

N21-10

Fren Kaliperi Fırçası



Fren kaliperinden fren tozu ve diğer kirleri temizlemek için, disk tipi frenlerde kullanılır, tek sıra çelik tel, askı delikli plastik sap

KOD NO	mm		FİYAT/TL
N21-10	220	1	

12 Özel Otomotiv Aletleri

C64W-H Serisi

1/2" Havalı Bijon Lokma Anahtarlar (Plastik Korumalı)



DuraMAX

6 köşe, yeni tasarım eski tasarıma göre 5 kat daha uzun kullanım ömrü sağlar, renk kodlu



KOD NO	Ømm	mm	RENK	FİYAT/TL
C64W-H17	17	86.5	Mavi	6
C64W-H19	19	86.5	Sarı	6
C64W-H21	21	86.5	Kırmızı	6

C64W-P03

3 Parça 1/2" Havalı Bijon Lokma Anahtar Takımı



CANTA GxYxD (mm)
147 x 104 x 40

KOD NO	FİYAT/TL
C64W-P03	1
3 PC: 17, 19, 21 mm	

C64-H17MB

1/2" Bijon Lokma Anahtarı
(Mercedes S-Class - Plastik Korumalı)



Mercedes S-Class otomobillerde kullanılan özel jant somunlarının sökölüp takılması için kullanılır

KOD NO	Ømm	mm	FİYAT/TL
C64-H17MB	17	78	6

N23-03K1AU

20 Parça Şifreli Jant Lokma Takımı (AUDI)

yeni
tasarım



Araçlardaki yonca yaprağı profilli şifreli bijonlar için, 17 mm jant lokması ile kullanılır

KOD NO	FİYAT/TL
N23-03K1AU	1
20 PC No: 801, 802, 803, 504, 805, 806, 807, 808, 809, 810, 811, 812, 813, 814, 815, 816, 817, 818, 819, 820	

N23-03K1BMW

20 Parça Şifreli Jant Lokma Takımı (BMW)

yeni
tasarım



Araçlardaki yonca yaprağı profilli şifreli bijonlar için, 17 mm jant lokması ile kullanılır

KOD NO	FİYAT/TL
N23-03K1BMW	1
20 PC No: 41, 42, 43, 44, 45, 46, 47, 48, 49, 50, 51, 52, 53, 54, 55, 56, 57, 58, 59, 60	

!
DİKKAT
N23-03 Serisi şifreli jant lokma takımları darbeli kullanım için uygun değildir
Sadece kurumlara satılır, şahıslara satışı yoktur

C64F-1819

1/2" Havalı Bijon Lokma Anahtarı
(İki Ağızlı - Ford / VW Amarok)

yeni



Ford ve VW Amarok otomobillerde kullanılan özel jant somunlarının sökölüp takılması için kullanılır, C61-70 Serisi uzatmalar ile kullanılır

KOD NO	Ømm	mm	FİYAT/TL
C64F-1819	18.5 x 19.5	76.5	6

N23-03K1VW

20 Parça Şifreli Jant Lokma Takımı (VW)

yeni
tasarım



Araçlardaki yonca yaprağı profilli şifreli bijonlar için, 17 mm jant lokması ile kullanılır

KOD NO	FİYAT/TL
N23-03K1VW	1
20 PC No: 521, 522, 523, 524, 525, 526, 527, 528, 529, 530, 531, 532, 533, 534, 535, 536, 537, 538, 539, 540	

N23-03K2BMW

20 Parça Şifreli Jant Somun Soket Lokma Takımı (BMW)

yeni



Araçlardaki yonca yaprağı profilli şifreli bijonlar için, 17 mm jant lokması ile kullanılır

KOD NO	FİYAT/TL
N23-03K2BMW	1
20 PC B11/15 ribs, B12/14 ribs, B13/16 ribs, B14/12 ribs, B15/11 ribs, B16/10 ribs, B17/7 ribs, B18/13 ribs, B19/8 ribs, B20/9 ribs, B30/13 point, BB31/15 point, BB32/16 point, BB33/17 point, BB34/18 point, BB35/19 point, BB36/20 point, BB37/21 point, BB38/22 point, BB40/23 point	

N23-03K2VW

22 Parça Şifreli Jant Somun Soket Lokma Takımı (VW)

yeni



Araçlardaki yonca yaprağı profilli şifreli bijonlar için, 17 mm jant lokması ile kullanılır

KOD NO	FİYAT/TL
N23-03K2VW	1
22 PC No: 51/6pt, 52/7pt, 53/8pt, 54/9pt, 55/10pt, 56/11pt, 57/12pt, 58/13pt, 59/14pt, 60/15pt, 61/16pt, 62/17pt, ABC0/10pt, ABC1/11pt, ABC2/13pt, ABC3/14pt, ABC4/14pt, ABC5/16pt, ABC6/17pt, ABC7/19pt, ABC8/20pt, ABC9/21pt	

N23-032038

Ağır Tip Bijon Anahtarı (Tek Ağız)



Ticari araçlar için

KOD NO	mm	mm	FİYAT/TL
N23-032038	20 x 38	400	1

N23-0750

Lastik Levyesi



KOD NO	mm	FİYAT/TL
N23-0750	500 - 20"	6

N23-011

4 Kollu Bijon Anahtarı



Özel takım çeliği, sertleştirilmiş ve temperlenmiş, çinko kaplama

KOD NO	mm	mm	FİYAT/TL
N23-011	17, 19, 21, 22	420	1

N23-08TD

Dijital Lastik Diş Derinlik Kumpası



Metrik ve inch ölçüler, geniş okuma ekranı, 0,01 mm hassasiyet, 1xCR2032 pil (dahil)

KOD NO	max. mm	FİYAT/TL
N23-08TD	25	1

N23-0525

Balans Kurşun Pensesi



Balans kurşunlarını sökmek, kesmek ve yerleştirmek için

KOD NO	mm	FİYAT/TL
N23-0525	240	12

N23-08MC

Michelin Lastik Şişirme Tabancası



Resmi Michelin lisanslı ürün, kompozit gövde, tekli klipsli konektör, 1,5 m hortum, 1/4" hava girişi, Nitrojen gazı için uygun, UNI EN12645:2014 standardına uygun

KOD NO	psi - bar	FİYAT/TL
N23-08MC	145 - 10	1

N23-0811D

Lastik Şişirme Tabancası (Dijital Göstergeli)

Yüksek hassasiyetli geniş dijital ekran, aydınlatmalı ekranı sayesinde gece kullanımına uygundur, -20° de hassas kullanım, Psi, Bar, Kpa, Kg/cm² okuma özelliği, 300 psi basınca dayanıklı 1/4" x 60 cm hortum, 2 x 1.5V AAA pil ile çalışır.

KOD NO	psi - bar	FİYAT/TL
N23-0811D	255 - 18	1

N23-0812G

Lastik Şişirme Tabancası



Psi / bar baskılı 63 mm çapında göstere, klipsli bağlantı elemanı, UNF 1/2"x20 vidalı hava girişi, alüminyum gövde

KOD NO	psi - bar	FİYAT/TL
N23-0812G	170 - 12	1

N23-0604

4 Parça Plastik Kazıma Seti

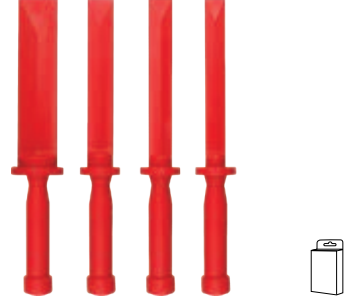

Balans kurşunlarının alışımlı jantlardan hasarsız şekilde çıkarılmasında kullanılır, ayrıca etiket ve yapışkanların çıkarılmasında da kullanılır, kimyasallara dayanıklıdır

KOD NO	mm	mm	FİYAT/TL
N23-0604	19, 22, 24, 36	265	1

N23-0825

Lastik Şişirme Jaki



Hava girişi 1/4" çapındaki hortumlara uygundur, krom kaplı çelik gövde ve zamak kafa, ergonomik kauçuk sap

KOD NO	mm	mm	FİYAT/TL
N23-0825	1/4	250	6

N23-0831

Lastik Hava Basınç Ölçer (Otomobiller için)



PSI ölçüm göstergeli, kalem tip tasarımı, askı klipsli, zamak kafa, krom kaplama çelik gövde

KOD NO	psi	mm	FİYAT/TL
N23-0831	10 - 120	135	25

N23-0832

Lastik Hava Basınç Ölçer (Ticari Araçlar için)



Otomobil ve ticari araçlar için, PSI ölçüm göstergeli, zamak kafa, krom kaplama çelik gövde

KOD NO	psi	mm	FİYAT/TL
N23-0832	10 - 150	300	10

12 Özel Otomotiv Aletleri

N23-10

Universal Rotil Çektirme



Otomobil ve hafif ticari araçların rotillerinin sökülmesi için, rot kolu ve stabilizörler gibi yürüyen aksam elemanları üzerinde bulunan rotillerin sökümünde kullanılır

KOD NO	Ø mm	h ^{max.} mm		FİYAT/TL
N23-10	22	50	1	

N23-11

Universal Rotil Çektirme (Kademeli Tip)



Rot kolu ve stabilizörler gibi yürüyen aksam elemanları üzerinde bulunan rotillerin sökümünde kullanılır, özellikle Alman araçları için

KOD NO	Ø mm	h ^{max.} mm		FİYAT/TL
N23-11	22	12-50	1	

N23-12 Serisi

Rotil Çektirmeler



Rot kolu ve stabilizörler gibi yürüyen aksam elemanları üzerinde bulunan rotillerin sökümünde kullanılır

KOD NO	GxY mm	Ø mm		FİYAT/TL
N23-1218	36x 38	18	1	
N23-1225	45x 47	25	1	
N23-1230	62x 66	30	1	
N23-1240	62x 77	40	1	
N23-1246	81x 81	46	1	

N23-08VCT

Lastik Supap İğne Sökme Tornavidası

yeni tasarım



Lastik supap iğnelerinin sökölüp takılmasında kullanılır



KOD NO	mm		FİYAT/TL
N23-08VCT	70	12	

N23-15 Serisi

Rot Kolu Sökme Aparatları



Araçlar üzerindeki rot kollarının kolayca sökölmesini sağlar, 30 mm anahtar ile kullanılır
N23-15P: Otomobiller için, N23-15C: Ticari araçlar için

KOD NO	Ø mm	mm		FİYAT/TL
N23-15P	34.5 - 39.5	430	1	
N23-15C	37.5 - 44	435	1	

N23-14 Serisi

Rotil Ayırma Çatalı



Rotillerin ayrılması için üniversal alet, kama şeklinde çatal ağızlar, dövülmüş gövde, mangan fosfat kaplı yüzey

KOD NO	Ø mm	mm		FİYAT/TL
N23-1418	18	400	6	
N23-1424	24	300	6	

N23-18 Serisi

1/2" Amortisör / Lastik Poyra Rulman Ayırıcı Lokmalar



12.5
1/2"

Amortisör ve rotıl montajının genişletmesinde kullanılır (amortisörü lastik poyra rulman yuvasından ayırma amaçlı)

KOD NO	mm	mm		FİYAT/TL
N23-1850	5.0x7	60	6	
N23-1855	5.5x8	50	6	

N23-19DH

Conta / Fitol / Keçe Sökme Aleti



Aktarma organlarında bulunan yağ contalarının, contaya ve döküm conta yuvalarına zarar vermeden çıkarılması için kullanılır

KOD NO	mm		FİYAT/TL
N23-19DH	300	6	

N23-42

Debriyaj Merkezleme Aleti



Brüt 5 tona kadar otomobil ve hafif ticari araçlar için, debriyaj balatasının baskı balatasına doğru şekilde merkezlenmesi ve montajı için özel alet, plastik gövde, metal vida, 3 adet mandren ile birlikte sunulur

KOD NO		FİYAT/TL
N23-42	10	

N23-38

Özel Segman Pensesi (Eğik Ağız-Merkezleme Delikli)



Kardan millerinde ve vites kutularında bulunan kör segmanlar için, merkezleme yuvalı açılı uçlar

KOD NO	mm		FİYAT/TL
N23-38	210	20	

N23-39

Özel Segman Pensesi (Düz Ağız)



Kardan millerinde ve vites kutularında bulunan kör segmanlar için, tırtırlı düz uçlar

KOD NO	mm		FİYAT/TL
N23-39	210	20	

N31-1105

5 Parça Döşeme ve Trim Sökme Takımı



Döşeme ve trim sökmek için set, yüzeylere zarar vermemesi için dayanıklı polyamid malzemeden üretilmiştir

KOD NO		FİYAT/TL
N31-1105	1	

N31-12

Döşeme Klips Sökme Aleti



Araçlardaki döşemeleri tutan klipslerin sökülmesinde kullanılır

KOD NO	mm		FİYAT/TL
N31-12	150	6	

N31-13

Döşeme Klips Sökme Pensesi



Araçlardaki döşemeleri tutan klipslerin sökülmesinde kullanılır

KOD NO	mm		FİYAT/TL
N31-13	240	12	

N31-14

Silecek Çektirmesi



Cam silecek kollarının hızlı ve güvenli bir şekilde çıkarılması için, bılyla uçlu itme civatası, krom kaplı gövde

KOD NO	mm		FİYAT/TL
N31-14	16	6	

N33-01BMC2/MS

Kaportacı Çekici (Düz Yuvarlak ve Tırtıklı Kare Kafa)



Germe ve doğrultma çekici, düz yuvarlak yüzey, damal kare yüzey, gerçek Amerikan cevizi ahşap saplar

KOD NO	mm	mm	mm		FİYAT/TL
N33-01BMC2/MS	43	43	335	6	

N33-01SPF

Kaportacı Çekici (Düz Yuvarlak ve Düz Keski Kafa)



Düz uçlu rötüşleme çekici, ince keski uç, düz yuvarlak kafa, gerçek Amerikan cevizi ahşap saplar

KOD NO	mm	mm		FİYAT/TL
N33-01SPF	43	335	6	

N33-01BPF

Kaportacı Çekici (Düz Yuvarlak ve Sivri Uçlu Bombe Kafa)



Yuvarlak uçlu rötüşleme çekici, nokta uç, düz yuvarlak kafa, gerçek Amerikan cevizi ahşap saplar

KOD NO	mm	mm		FİYAT/TL
N33-01BPF	43	335	6	

N33-02UA

Üniversal Ray Dayama

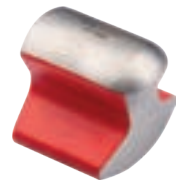

Taşlanmış yüzeyler

KOD NO	GxDxY mm		FİYAT/TL
N33-02UA	61.5 x 70 x 63.5	6	

N31-APW2

Montaj Hava Yastığı

yeni

- 2 mm'den 50 mm'ye kadar olan boşluklardaki elemanların (Pencere, kapı vs.) hızlı ve kolay montajı için, tek elle hassas çalışma,
- Özellikle araba kapılarının açılması için uygundur. Üzerindeki valf sayesinde yastık boyutu sürekli ayarlanabilir.



KOD NO	Basınç	GxY mm		FİYAT/TL
N31-APW2	Yaklaşık 100 kg/pc.	150x160	6	

12 Özel Otomotiv Aletleri

N33-02PW

Kama Dayama



Taşlanmış yüzeyler

KOD NO	GxDxY mm		FİYAT/TL
N33-02PW	64 x 112 x 25.8	6	

N33-02CW

Virgül Dayama



Taşlanmış yüzeyler

KOD NO	GxDxY mm		FİYAT/TL
N33-02CW	58.5 x 132 x 44.2	6	

N33-02HE

Topuk Dayama



Taşlanmış yüzeyler

KOD NO	GxDxY mm		FİYAT/TL
N33-02HE	80 x 60.5 x 29.5	6	

N33-02TO

Tırnak Dayama



Taşlanmış yüzeyler

KOD NO	GxDxY mm		FİYAT/TL
N33-02TO	118.5 x 54.5 x 23.5	6	

N33-02DE

Topuz Dayama



Taşlanmış yüzeyler

KOD NO	GxDxY mm		FİYAT/TL
N33-02DE	Ø 55.5 x Ø 55.5 x 57.5	6	

N33-02PWC

Bombeli Dayama



Taşlanmış yüzeyler

KOD NO	GxDxY mm		FİYAT/TL
N33-02PWC	126 x 66.5 x 27.5	6	

N33-03SL

Uzun Tek Ağızlı Trança (Düz Ağız)



Kaplamalı gövde, taşlanmış yüzeyler

KOD NO	LxGxY mm		FİYAT/TL
N33-03SL	391 x 56.8 x 25.8	6	

N33-03SS

Kısa Tek Ağızlı Trança (Düz Ağız)



Kaplamalı gövde, taşlanmış yüzeyler

KOD NO	LxGxY mm		FİYAT/TL
N33-03SS	286 x 51 x 68.5	6	

N33-03DS

Çift Ağızlı Trança (Kavisli ve Düz Ağız)



Kaplamalı gövde, taşlanmış yüzeyler

KOD NO	LxGxY mm		FİYAT/TL
N33-03DS	401 x 59.5 x 172.7	6	

N33-04

Kaportacı Eğe Kolu (Yedekli)



14" kaportacı eğeleri için, düz ve eğimli kullanım için ayar vidası

KOD NO	mm	TESLİMAT		FİYAT/TL
N33-04	370	N33-04F + N33-04R	1	
N33-04F	370	Sadece Kol	1	



KOD NO	mm	Yedek Eğe		FİYAT/TL
N33-04R	350		6•	

N33-04RC Serisi

Kaportacı Eğe Yedekleri (Radyal Kesim)



Düz, frezelenmiş kavisli kesim, DuraMAX kalitesi

KOD NO	mm	TPI*		FİYAT/TL
N33-04R1C	350	9	12	
N33-04R2C	350	12	12	

TPI: İnc başına düşen diş sayısı

N33-04RD Serisi

Kaportacı Eğe Yedekleri (Çapraz Kesim)



Düz, frezelenmiş çapraz kesim

KOD NO	mm	TPI*		FİYAT/TL
N33-04R1D	350	9	12	
N33-04R2D	350	12	12	
N33-04R3D	350	18	12	

TPI: İnc başına düşen diş sayısı

N36-WRT

Cam Sökme Aparatı



Araç camlarının sökülmesinde kullanılır, aletin sertleştirilmiş kesici ucu yapışkan cam macununu keser

KOD NO	mm		FİYAT/TL
N36-WRT	165	1	

N36-WH2

Cam Ayırma Telleri İçin Tutucu Sap (Çift)



Cam ayırma telleri için plastik saplı tutucu alet, çift olarak satılır

KOD NO	mm		FİYAT/TL
N36-WH2	98	1	

N36-CS0722

Cam Macunu Kesme Teli



Paslanmaz Çelik

Araç camlarının etrafındaki yapışkan macunun kesiminde kullanılır, kare kesitlidir

KOD NO	mm	m		FİYAT/TL
N36-CS0722	0.7	22	20	

N33-05C

Kaporta Punta Kaynak Pensesi

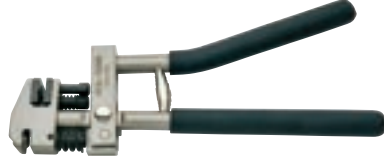

Kaporta kenarlarını ezmek, kaporta üzerine kaynak amaçlı delik açmak için kullanılır, yüksek zaman tasarrufu sağlar

KOD NO	mm	L mm		FİYAT/TL
N33-05C	5	10	1	

N37-02SM1

Kurt Ağız (Dar Çene/Tek Yön)



Özellikle dar alanlarda kullanılmak için, tek yönlü çekme, Tutma yüzeyi: 44 mm (genişlik) / 24 mm (derinlik)

KOD NO	KAPASİTE ton		FİYAT/TL
N37-02SM1	5	1	

N37-02SM2

Kurt Ağız (Dar Çene/Çift Yön)



Özellikle dar alanlarda kullanılmak için, çift yönlü çekme, Tutma yüzeyi: 44 mm (genişlik) / 24 mm (derinlik)

KOD NO	KAPASİTE ton		FİYAT/TL
N37-02SM2	5 (I) - 2 (II)	1	

N37-02SJ1

Kurt Ağız (Simetrik Çene)



İki ağız birbiriyle aynıdır (simetrik), tek yönlü çekme, Tutma yüzeyi: 37 mm (genişlik) / 15 mm (derinlik)

KOD NO	KAPASİTE ton		FİYAT/TL
N37-02SJ1	3	1	

N36-1002

Cam Vantuzu (iki Kafalı)



Cam, seramik, plastik, sac metal ve çeşitli malzemeleri taşımak için, yatay pozisyonda 80 Kg'a kadar yük taşıma kapasitesi

KOD NO	mm	mm		FİYAT/TL
N36-1002	115	370	1	

N37-02AJ1

Kurt Ağız (Asimetrik Çene)



İki ağız birbirinden farklıdır (asimetrik), tek yönlü çekme, Tutma yüzeyi: 37 mm (genişlik) / 15 mm (derinlik)

KOD NO	KAPASİTE ton		FİYAT/TL
N37-02AJ1	3	1	

N37-02HD1

Kurt Ağız (Ağır Tip)



İki ağız birbirinden farklıdır (asimetrik), tek yönlü çekme, Tutma yüzeyi: 37 mm (genişlik) / 15 mm (derinlik)

KOD NO	KAPASİTE ton		FİYAT/TL
N37-02HD1	5	1	

N37-02FR1

Kurt Ağız (Yassı Tip)



Yassı yapı, uzun alet ömrü, tek yönlü çekme, Tutma yüzeyi: 118 mm (genişlik) / 18 mm (derinlik)

KOD NO	KAPASİTE ton		FİYAT/TL
N37-02FR1	5	1	



Bölüm /1 Sayfa 26



12 Özel Otomotiv Aletleri

N41-10

Akü Bomesi



Akü sıvısının içindeki elektrolit yoğunluğunu ölçmek için kullanılır, tüp şeklinde kompozit gövde, kolay okunabilir skala

KOD NO	mm		FİYAT/TL
N41-10	200	10	

G09-11

Oto Elektrik Kontrol Kalem



Işık göstergeli prinç gövde, 850 mm kıskaçlı kablo

KOD NO	DC (V)		FİYAT/TL
G09-11	6-24	10	

G09-16

Profesyonel Oto Elektrik Kontrol Kalem



Yayı, yalıtım yoluyla test etmek için prob, ikiz LED'ler canlı devre ve polarizasyonu gösterir, 850 mm kıskaçlı kablo

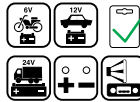

KOD NO	DC (V)		FİYAT/TL
G09-16	3-48	10	

N42-01M10

1/2" XZN Alternatör Lokması



Alternatörde bulunan V (dişli) kayış kasmağının sökülüp takılması için

KOD NO		mm		FİYAT/TL
N42-01M10	M10	17	25	

N42-01T50

1/2" TORX Alternatör Lokması



Alternatörde bulunan V (dişli) kayış kasmağının sökülüp takılması için

KOD NO		mm		FİYAT/TL
N42-01T50	T50	17	25	

N42-01K13

13 Parça Alternatör Kasmağı Sökme Kiti

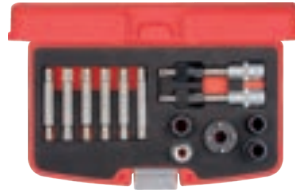

ÇANTA GöxYxD (mm)
245 X 129 X 40

Alternatörde bulunan V (dişli) kayış kasmağının sökülüp takılması için komple takım

KOD NO		FİYAT/TL
N42-01K13	1	

N43-1020

20 Parça Oto Teyp Sökme Aparat Takımı



Araç radyolarını sökmek için çeşitli aparatlar, plastik kılıfı

Uygulama:

Teyp Markaları: Alpine, Blaupunkt, Becker, JVC, Pioneer, VDO
Araç Modelleri: BMW, Fiat, Ford, Mercedes, Opel, PSA, Renault, VAG

KOD NO		FİYAT/TL
N43-1020	1	

N43-01K1UNI

12 Parça Soket Konnektör Çıkarma Takımı (Universal)

yeni
tasarım



ÇANTA GöxYxD (mm)
315 x 155 x 50

KOD NO		FİYAT/TL
N43-01K1UNI	1	

N43-01T 12 PC: (01 + 02 + 04 + 01S + 02S + 04S + 10 + 14 + 15 + 20 + 30 + 31)
Ref. CE-01, CE-05, CE-02, 01S, 02S, 04S, CE-56, CE-59, CE-62, CE-91, CE-74, CE-53)

N43-01K1VAG

11 Parça Soket Konnektör Çıkarma Takımı (VW/Audi)

yeni
tasarım



ÇANTA GöxYxD (mm)
315 x 155 x 50

KOD NO		FİYAT/TL
N43-01K1VAG	1	

N43-01T 11 PC: (01 + 04 + 01S + 04S + 10 + 11 + 12 + 13 + 20 + 30 + 31)
Ref. CE-01, CE-02, 01S, 04S, CE-56, CE-56-1, CE-57, CE-58, CE-91, CE-74, CE-53)



N43-01T Serisi

Soket Konnektör Çıkarma Aletleri (Yuvarlak Kontakt)



Yuvarlak ek bileşenli duylar için, kontakt yüksükleri dahil, katlanabilir sap dizaynı

Uygulama:**N43-01T01 + N43-01T01S:** BMW, Mercedes-Benz, Fiat, MAN, Opel, Porsche, Seat, Skoda, VW/Audi**N43-01T02 + N43-01T02S:** Ford, Opel, PSA, Renault**N43-01T04 + N43-01T04S:** BMW, Mercedes-Benz, Fiat, MAN, Opel, Porsche, Seat, Skoda, VW/Audi

KOD NO	Ref.	Ø mm		FİYAT/TL
N43-01T01	CE-01	1.5	1	
N43-01T02	CE-05	2.3	1	
N43-01T04	CE-02	3.5	1	

N43-01TS Serisi

Yedek Yuvarlak Kontakt Yüksükleri (N43-01T Serisi için)



N43-01T01 ile N43-01T04'e kadar olan modeller için

KOD NO		L mm		FİYAT/TL
N43-01T01S	N43-01T01	30	1	
N43-01T02S	N43-01T02	35	1	
N43-01T04S	N43-01T04	24	1	

N43-01T10

Soket Konnektör Çıkarma Aleti (Micro-Timer II, III)



Düz soketler ve Micro-Timer II, III kontaktlar için, katlanabilir sap dizaynı

Uygulama:

Mercedes-Benz, Opel, Porsche, PSA, Renault, Saab, Seat, Skoda, VW/Audi

KOD NO	Ref.	□ mm		FİYAT/TL
N43-01T10	CE-56	1.6	1	

N43-01T11

Soket Konnektör Çıkarma Aleti (Yassı Kontakt-Çift Kanal) - 0.64 mm



Çift kanallı terminallerdeki asimetrik mandallı yassı soketler için, katlanabilir sap dizaynı

Uygulama:

Seat, Skoda, VW/Audi

KOD NO	Ref.	□ mm		FİYAT/TL
N43-01T11	CE-56-1	0.64	1	

N43-01T/12-13

Soket Konnektör Çıkarma Aletleri (Yassı Kontakt-Çift Kanal)



Çift kanallı terminallerdeki asimetrik mandallı yassı soketler için, katlanabilir sap dizaynı

Uygulama:

Seat, Skoda, VW/Audi

KOD NO	Ref.	□ mm		FİYAT/TL
N43-01T12	CE-57	2.8	1	
N43-01T13	CE-58	4.8	1	

N43-01T14

Soket Konnektör Çıkarma Aleti (Maxi Power Timer)



Düz yuvalı ve Maxi Power Timer kontaktlar için, katlanabilir sap dizaynı

Uygulama:

Mercedes-Benz, VW/Audi

KOD NO	Ref.	□ mm		FİYAT/TL
N43-01T14	CE-59	9.5	1	

N43-01T15

Soket Konnektör Çıkarma Aleti (Pit-Pod)



Düz yuvalı fişler ve Pit-Pod kontaktlar için, katlanabilir sap dizaynı

Uygulama:

Tüm araç modelleri

KOD NO	Ref.	□ mm		FİYAT/TL
N43-01T15	CE-62	çeşitli	1	

N43-01T20

Soket Konnektör Çıkarma Aleti (JPT/SPT)



Çift kanallı terminallerdeki yassı soketler ve JPT / SPT kontaktlar için, katlanabilir sap dizaynı

Uygulama:

BMW, Mercedes-Benz, Fiat, Ford, MAN, Opel, PSA, Renault, Saab, VW/Audi

KOD NO	Ref.	□ mm		FİYAT/TL
N43-01T20	CE-91	2.8, 5.8	1	

N43-01T30

Soket Konnektör Çıkarma Aleti (Micro Timer I)



Düz yuvalı fişler, Micro-Timer I kontaktlar ve ABS fiş yuvası için, katlanabilir sap dizaynı

Uygulama:

Fiat, Ford, Mazda, Opel, PSA, Renault, Saab, VW/Audi

KOD NO	Ref.	□ mm		FİYAT/TL
N43-01T30	CE-74	1.6	1	

N43-01T/31-32

Soket Konnektör Çıkarma Aletleri (Yassı Kontakt)



Tek kanallı terminallere kilitli yassı soketler için katlanabilir sap dizaynı

Uygulama:

BMW, Mercedes-Benz, Ford, MAN, Opel, Porsche, PSA, Renault, Seat, Skoda, VW/Audi

N43-01T32: BMW, PSA, Renault

KOD NO	Ref.	□ mm		FİYAT/TL
N43-01T31	CE-53	2.8, 5.8	1	
N43-01T32	CE-54	2.8	1	



13 Ölçü Aletleri

162 | 164



P01 Serisi Pro Brake Şerit Metreler

Pro Brake



EEC II sınıfı hassasiyet, maksimum dayanıklılık için naylon kaplı çift taraf baskılı şerit, tırnak üzerinde kuvvetli mıknatıs, şeridin geri sarımı esnasında tam kontrol için kuvvetli stop mekanizması, piyano siyahı ABS kasa

KOD NO	m	mm	FİYAT/TL
P01-0522	5	22	8•
P01-0527	5	27	8•
P01-0827	8	27	8•

P05B Serisi Compact Şerit Metreler (Siyah Kasa)

Compact



EEC II sınıfı hassasiyet, Kolay kullanım için sınıftaki en küçük kasaya sahip tasarım, Benzersiz çift stop mekanizması, Tırnak üzerinde kuvvetli iki adet mıknatıs

KOD NO	m	mm	FİYAT/TL
P05B-0519	5	19	8•
P05B-1025	10	25	8•

P05 Serisi Compact Şerit Metreler

Compact



EEC II hassasiyet sınıfı, metrik, çift stop mekanizması

KOD NO	m	mm	FİYAT/TL
P05-0316	3	16	12•
P05-0516	5	16	12•
P05-0519	5	19	12•
P05-0525	5	25	12•
P05-1025	10	25	8•

P03 Serisi C-Pro Şerit Metreler (Metrik)

C-Pro



EEC 2 hassasiyet sınıfı, metrik, çift tarafı baskılı çelik şerit, darbelerle karşı dayanıklı çift bileşenli ABS gövde

KOD NO	m	mm	FİYAT/TL
P03-0316	3	16	12•
P03-0519	5	19	8•
P03-0525	5	25	8•

P05S-0519 Compact Şerit Metre (Paslanmaz Çelik)

Compact



Paslanmaz Çelik

Tüm metal bileşenleri paslanmaz çelik, nemli ve ıslak çalışma ortamları için uygun, EEC II hassasiyet sınıfı, metrik, çift stop mekanizması

KOD NO	m	mm	FİYAT/TL
P05S-0519	5m-16ft	19	12•

P05A Serisi Compact Şerit Metreler (Inch/Metrik)

Compact



EEC II hassasiyet sınıfı, inç/metrik, çift stop mekanizması

KOD NO	m	mm	FİYAT/TL
P05A-0316	3m-10ft	16	12•
P05A-0519	5m-16ft	19	12•

P10 Serisi

C-Grip Arazi Metreleri (Fiberglas Şerit)



EEC II hassasiyet sınıfı, metrik, çift taraflı baskılı fiberglas şerit, kısıkaçlı halka, darbelerle karşı dayanıklı çift bileşenli ABS gövde, hızlı sarma mekanizması

KOD NO	m	mm		FİYAT/TL
P10-10	10	15	1	
P10-20	20	15	1	
P10-30	30	15	1	

P05-AD2

Arkası Yapışkanlı Metre Şeridi



EEC 2 hassasiyet sınıfı, metrik, yapışkan çelik şerit, boydan kesilebilir, çalışma masaları, testere tezgahları v.b. için ideal

KOD NO	m	mm		FİYAT/TL
P05-AD2	2	13	12	

P17-B03

Çırpı İpi Takımı



KOD NO	m		FİYAT/TL
P17-B03	30	6	

P07 Serisi

C-Pro Arazi Metreleri (Çelik Şerit)



EEC 2 hassasiyet sınıfı, metrik, çelik şerit, kısıkaçlı halka, hızlı döndürme kolu, ergonomik plastik gövde

KOD NO	m	mm		FİYAT/TL
P07-20	20	13	1	
P07-30	30	13	1	
P07-50	50	13	1	

29100 Serisi

Marin Derinlik Metreleri (Paslanmaz Çelik Şerit)



Paslanmaz Çelik

EEC 2 hassasiyet sınıfı, silo ve tanklarda sıvıların derinlik ölçümleri için, paslanmaz çelik şerit, hızlı döndürme kolu hafif alüminyum gövde **29100D şakülle birlikte sunulur**

KOD NO	m	mm		FİYAT/TL
29110	10	13	1	
29120	20	13	1	

29100D

Şakül (29100 Serisi için)



29100 marin derinlik metresi şakülü, malzeme: MS58

KOD NO	mm		FİYAT/TL
29100D	100	500	1

P45D

Dijital Kumpas



Paslanmaz Çelik

Metrik ve inch dijital göstere, 0.01 mm ve 0.0005" hassasiyet, sıfırlama butonu, iç, dış ve derinlik ölçümü, paslanmaz çelik gövde, 1xLR44 pil (dahil), plastik kutulu

KOD NO				FİYAT/TL
P45D	0-150	0-6	10	

P45A

Mekanik Kumpas



Paslanmaz Çelik

Metrik ve inch ölçüm, 0.02 mm ve 1/1000" hassasiyet, iç, dış ve derinlik ölçümüne uygun, plastik kutulu

KOD NO				FİYAT/TL
P45A	0-150	0-6	10	

P47 Serisi

Mikrometreler



Metrik ölçüm, 0.01 mm okuma aralıkları, kilitleme mandalı, cırcır stop mekanizması, karbit uçlar, ayar anahtar, plastik kutulu

KOD NO			FİYAT/TL
P47-025	0- 25 mm	1	
P47-050	25- 50 mm	1	
P47-075	50- 75 mm	1	
P47-100	75-100 mm	1	

13 Ölçü Aletleri

P15 Serisi

Çelik Cetveller



Paslanmaz Çelik

Sınıf II hassasiyet, metrik, paslanmaz çelik, silinmez markalama, yansımaya yapmayan yüzey

KOD NO	cm	mm	FİYAT/TL
P15-015	15	13	50
P15-030	30	25	10
P15-050	50	30	10
P15-100	100	30	10

P54-20S

Filler Çakısı (Metrik - 20 Yaprak)



100 mm uzunluğunda konik bıçaklar, sertleştirilmiş, polisajlı yüzeyler, kelebek vidayla sıkıştırılmış çelik kasa

KOD NO	mm	FİYAT/TL
P54-20S	0.05-1.00	100 6

P54A-25S

Filler Çakısı (SAE - 25 Yaprak)



90 mm uzunluğunda bıçaklar, sertleştirilmiş, polisajlı yüzeyler, kelebek vidayla sıkıştırılmış çelik kasa

KOD NO	inch	mm	FİYAT/TL
P54A-25S	.002 - .025	90	6

P55-52MW

Vida Tarağı (Metrik/Whitworth) - 52 Yaprak



ISO metrik 60° ve Whitworth 55° dişler için, paslanmaz çelik
Metrik: 0.25, 0.30, 0.35, 0.40, 0.45, 0.5, 0.6, 0.7, 0.75, 0.8, 0.9, 1.0, 1.25, 1.5, 1.75, 2.0, 2.5, 3.0, 3.5, 4.0, 4.5, 5.0, 5.5, 6.0 mm
Whitworth: 4, 4-1/2, 5, 6, 7, 8, 9, 10, 11, 12, 13, 14, 16, 18, 19, 20, 22, 24, 25, 26, 28, 30, 32, 36, 40, 48, 60, 62 TPI

KOD NO	mm	TPI	FİYAT/TL
P55-52MW	0.25-6	62-4	5

P21 Serisi

Alüminyum Su Terazileri-Standart

ACCUVISION

30 Yıl Tüp Garantisi



Profesyonel kalite, 0.50 mm/m (.0029°) hassasiyet, ultrasonik blok tüpler, sağlam alüminyum gövde, düşmelere dayanıklı darbe emici kapaklar

KOD NO	mm	FİYAT/TL
P21-030	30	10
P21-040	40	10
P21-050	50	10
P21-060	60	10
P21-070	70	10
P21-080	80	10
P21-100	100	10
P21-120	120	10
P21-150	150	10

P21-M Serisi

Alüminyum Su Terazileri-Mıknatıslı

ACCUVISION

30 Yıl Tüp Garantisi



Profesyonel kalite, 0.50 mm/m (.0029°) hassasiyet, ultrasonik blok tüpler, sağlam alüminyum gövde, düşmelere dayanıklı darbe emici kapaklar, mıknatıslı

KOD NO	mm	FİYAT/TL
P21-060M	60	10
P21-080M	80	10
P21-100M	100	10

P21-012M

Alüminyum Su Terazisi-Mini

ACCUVISION

30 Yıl Tüp Garantisi



Profesyonel kalite, 0.50 mm/m (.0029°) hassasiyet, ultrasonik blok tüp, sağlam alüminyum gövde, düşmelere dayanıklı darbe emici kapaklar, mıknatıslı, yatay ölçüm için

KOD NO	mm	FİYAT/TL
P21-012M	12	10

P24M-022

Mini Su Terazisi / Döküm Gövde



Profesyonel kalite, 0.50 mm/m (.0029°) hassasiyet, ultrasonik blok tüpler, mıknatıslı

KOD NO	mm	FİYAT/TL
P24M-022	22	12

P26 Serisi

Su Terazisi Tüpleri

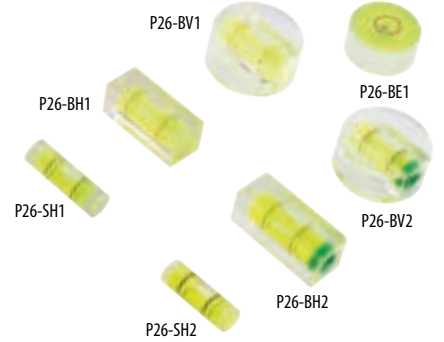

Özel fosforlu sıvı, ultrasonik olarak kapatılmış, kaliteli akrilik gövde

KOD NO	mm	mm	mm	FİYAT/TL
P26-BE1	18	9	-	12•
P26-BV1*	36	17	-	12•
P26-BV2*	35	16	-	12•
P26-BH1	-	15	36	12•
P26-SH1	9.5	-	31	50•
P26-SH2*	9.8	-	30	12•

* Stoklarla sınırlıdır.

14 Genel Bakım ve Atölye Aletleri

165 | 180



Yeniden Tasarlanan Kablosuz LED Çalışma Lambaları Serisi

LU-MAX

Güçlü ve homojen aydınlatma

Ceta Form, 2021'de Asya'da LED çalışma lambaları üretiminde uzmanlaşmış bir ortak girişime yatırım yaptı. Bu katalogta, bu tesiste üretilen ilk seriyi göstermekten mutluluk duyuyoruz - tasarım ve performans açısından gerçekten daha iyi. Bu yeni fabrikanın sağlayacağı yetenekler sayesinde, sürekli büyüyen LED çalışma lambası pazarında önemli bir oyuncu olmayı hedefliyoruz.



R10-MAX01

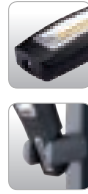

700 lümen



100% CETA FORM Tasarımı

eski kod R10-MAX1

Şarjlı LED Çalışma Lambası

Ana ışık: 7W COB LED 700-350-175 lümen
Tepe ışık: 4W SMD LED 150 lümen
Pil: 3.7V 2600 mAh Li-ion
Çalışma süresi: 2 s- 4s - 8s / Tepe ışık 7s
Şarj süresi: 3.5s, pil seviye göstergesi
Koruma sınıfı: IP65 / IK07
YxGxD: 268 x 60 x 40 mm



R10-MAX02

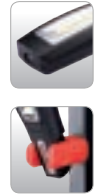

400 lümen



100% CETA FORM Tasarımı

eski kod R10-MAX2

Şarjlı LED Çalışma Lambası

Ana ışık: 4W COB LED 400 lümen
Tepe ışık: 4W SMD LED 120 lümen
Pil: 3.7V 2600 mAh Li-ion
Çalışma süresi: Ana ışık 5s / Tepe ışık 10s
Şarj süresi: 3.5s, pil seviye göstergesi
Koruma sınıfı: IP54 / IK07
YxGxD: 268 x 60 x 40 mm

14 Genel Bakım ve Atölye Aletleri



J49

SYROX
Şarj Adaptörü - 1.0A



400
lümen



120 Lümen



2 Kademe



180°

Ayarlanabilir



Mıknatıs

Taban



USB Tip C



%100
CETA FORM
Tasarımı

R10-MIDI

Şarjlı LED Midi Çalışma Lambası

Ana ışık: 4W COB LED 400-250 lümen

Tepe ışık: 4W SMD LED 100 lümen

Pil: 3.7V 2600 mAh Li-ion

Çalışma süresi: Ana ışık 3.5s - 5s/ Tepe ışık 10s

Şarj süresi: 3.5s, pil seviye göstergesi

Koruma sınıfı: IP54 / IK07

YxGxD: 198 x 56 x 34 mm

yeni



150
lümen



150 Lümen



Mıknatıs

Arka



USB Tip C



%100
CETA FORM
Tasarımı

R10-MINI1

Şarjlı LED Kalem Tipi Çalışma Lambası

Ana ışık: 7 x 0.5W COB LED 150 lümen

Tepe ışık: 1 x 1W SMD LED 80 lümen

Pil: 3.7V 800 mAh Li-ion

Çalışma süresi: Ana ışık 3s / Tepe ışık 5s

Şarj süresi: 2s

Koruma sınıfı: IP20 / IK07

YxGxD: 165 x 24.5 x 21 mm

Şarjlı LED Midi Kaçak Arama Lambası /UV

Araç soğutma sistemlerindeki kaçakların tespitinde kullanılır. UV kaçak tespit sıvısı ile kullanılır. Ana ışık UV özellikli, tepe ışık normal LED özelliklidir.

Şarjlı LED Renk Kontrol Lambası

Farklı LED özellikleri sayesinde bu lamba gün ışığını simüle eder. Boya, cila, parlatma, temizleme ve ön hazırlık aşamaları için ideal aydınlatma sağlar.

ColorFix

3 renkli ışık



R10-MIDI/UV

Şarjlı LED Midi Kaçak Arama Lambası /UV

Ana ışık: 3W COB LED, 395 dalga boyu

Tepe ışık: 1W SMD LED 100 lümen

Tip C USB: 5V-1A

Pil: 3.7 V 2600 mAh Li-ion

Çalışma süresi: Ana ışık UV - 4.5s / Tepe ışık 10s

Şarj süresi: 3.5s

Koruma sınıfı: IP54 / IK07

YxGxD: 198 x 56 x 34 mm



R10-CLR

Şarjlı LED Boya Kontrol Lambası

Ana ışık: Yüksek CRI ve 3CCT

5W COB LED 500 lümen

CRI: 96 CRI+ CCT: 2700K - 4500K - 6500K

Pil: 3.7 V 2600 mAh Li-ion

Çalışma süresi: 2s

Şarj süresi: 4s

Koruma sınıfı: IP65 / IK07

YxGxD: 190 x 56 x 36 mm

14 Genel Bakım ve Atölye Aletleri

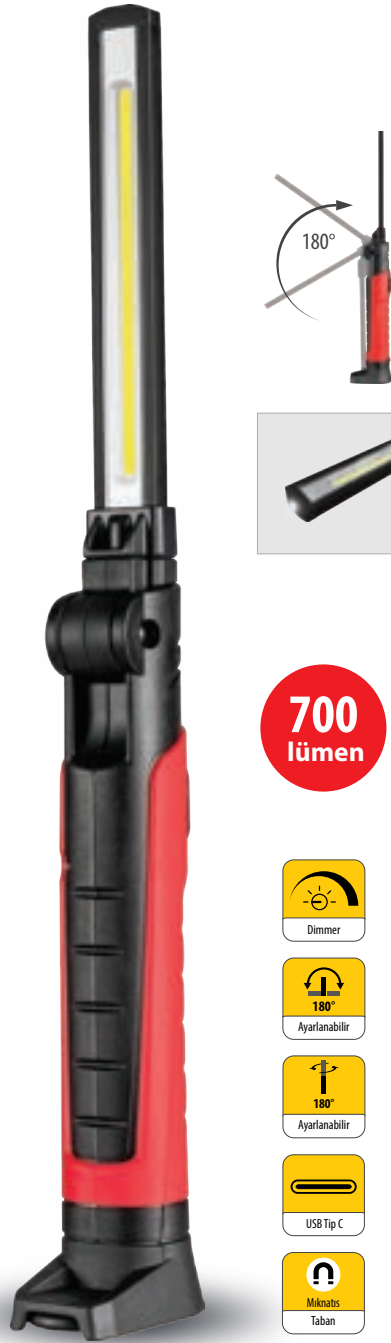

R10F-SLIM1

LuMax Şarjlı LED Çalışma Lambası - Slim

Ana ışık: 7W COB LED, Yüksek Mod: 700 lümen,

Tepe ışık: 3W SMD LED 120 lümen

CRI: 80 CRI+ CCT: 6500K

Pil: 3.7 V 2600 mAh Li-ion

Çalışma süresi: Ana ışık 2s-16s / Tepe ışık 9s

Şarj süresi: 4s, pil seviye göstergesi

Koruma sınıfı: IP54 / IK07

YxGxD: 397 x 66.5 x 46 mm



R10F-SLIM2

Şarjlı LED Çalışma Lambası - Ultra Slim

Ana ışık: 2W COB LED, Normal Mod: 280 lümen, Eko Mod: 90 lümen

Tepe ışık: SMD LED / 80 lümen

Arka ışık: COB LED 160 lümen

CRI: 70 CRI+ CCT: 6500K

Pil: 3.7 V 700 mAh Li-ion

Çalışma süresi: Ana ışık 1.5s - 4.5s 30d, Arka ışık 2.5s Tepe ışık 3s

Şarj süresi: 2s, pil seviye göstergesi

Koruma sınıfı: IP54 / IK07

YxGxD: 164/307 x 20 x 19 mm

yeni

%100
CETA FORM
Tasarımı400
lümen

Alın rahatlığı için TPE astar



R12-PRO1

Şarjlı LED Kafa Lambası (Hareket Sensörlü)Ana ışık: 3W COB LED Normal Mod: 400 lümen,
Eko Mod: 200 lümen, Sensör Mod: 400 lümen

CRI: 80 CRI+ CCT: 6500K

Pil: 3.7V 1500mAh Li-Po

Çalışma süresi: 2s-6s

Şarj süresi: 2.5s

Koruma sınıfı: IP65 / IK07

YxGxD: 50 x 77 x 45 mm

yeni

%100
CETA FORM
Tasarımı150
lümen

Alın rahatlığı için TPE astar

**LED Kafa Lambası (3AAA)**

Ana ışık: 3W COB LED

Normal Mod: 150 lümen, Eko Mod: 40 lümen

S.O.S Fonksiyonu

CRI: 80 CRI+ CCT: 6500K

Pil: 3x1.5V AAA pil (dahil değildir)

Koruma sınıfı: IP20

YxGxD: 49x 78x 43 mm

yeni

%100
CETA FORM
Tasarımı300
lümen

R10-COM1

Şarjlı LED Kompakt Çalışma Lambası

Ana ışık: 3W COB LED

Normal Mod: LED 300 lümen, Eko Mod: 100 lümen

CRI: 80 CRI+ CCT: 6500K

Pil: 3.7V 1500mAh Li-Po

Çalışma süresi: 3s - 8.5s

Şarj süresi: 3s, pil seviye göstergesi

Koruma sınıfı: IP54 / IK07

YxGxD: 127 x 66 x 30 mm

14 Genel Bakım ve Atölye Aletleri

yeni

1000
lümen



3 Kademe



1000 Lümen



250 Lümen



USB Tip C



Mıknatıs
Taban



180°
Ayarlanabilir

R14-CF10

Şarjlı Kompakt LED Projektör Lamba - 1000 Lümen
Projektör aydınlatma: 10W COB LED, Yüksek Mod: 1000 lümen, Normal Mod: 500 lümen, Eko Mod: 250 lümen
Fener aydınlatma: SMD LED / 250 lümen
CRI: 80 CRI+ CCT: 6500K
Pil: 3.7 V 2600 mAh Li-ion
Çalışma süresi: Projektör 2s, 5s, 10s / Fener 6s
Şarj süresi: 3s, pil seviyesi göstergesi
Koruma sınıfı: IP65 / IK07
YxGxD: 94.5 x 82.7 x 43 mm

%100
CETA FORM
Tasarımı



yeni

2000
lümen



3 Kademe



2000 Lümen



500 Lümen



USB Tip C



Mıknatıs
Taban



180°
Ayarlanabilir

R14-CF20

Şarjlı Kompakt LED Projektör Lamba - 2000 Lümen
Projektör aydınlatma: 15W COB LED, Yüksek Mod: 2000 lümen, Normal Mod: 1000 lümen, Eko Mod: 500 lümen
Fener aydınlatma: SMD LED / 500 lümen
CRI: 80 CRI+ CCT: 6500K
Pil: 3.7 V 5200 mAh Li-ion
Çalışma süresi: Projektör 3s, 8s, 15s / Fener 8s
Şarj süresi: 4s, pil seviyesi göstergesi
Koruma sınıfı: IP65 / IK07
YxGxD: 118 x 103 x 48mm

%100
CETA FORM
Tasarımı



LU-MAX PRO

Profesyonel El Fenerleri (Focus)

Ceta Form'un üst segment el feneri programı

Bu ürün grubu en talepkâr profesyonel kullanıcıların beklentileri esas alınarak geliştirilmiştir. Pillerinden LED çiplerine, ana kartlarından alüminyum gövdelerine en üst kalite malzemelerden üretilmiştir. Profesyonel kullanıcıların bu serideki ürünlerin kalitesini ve performansını kısa sürede fark edeceklerine eminiz.

**250
lümen**

2000cd

Işık Şiddeti



89 m

Aydınlatma



9 h

Çalışma Süresi



Kolay Focus



Düşmeye Dayanıklı



IP54

R.P6

2AA El Feneri (Focus Özellikli)

LED CREE XPG2 S3
MOD Açma / Kapama
Işık gücü 250 lümen
Çalışma süresi 9s
2xAA pil (dahil)
Aydınlatma mesafesi 89 m
Işık şiddeti 2000cd
YxGxD: 150.3 x Ø28.2 x Ø20.4 mm

**450
lümen**

8000cd

Işık Şiddeti



179 m

Aydınlatma



15 h

Çalışma Süresi



Kolay Focus



Düşmeye Dayanıklı



IP54

R.P7

4AA El Feneri (Focus Özellikli)

LED CREE XPG2 S3
MOD Yüksek/Düşük
Işık gücü 50/450 lümen
Çalışma süresi 15s-2s
4xAA pil (dahil)
Aydınlatma mesafesi 179 m
Işık şiddeti 8000cd
YxGxD: 131.4 x Ø37 x Ø30.2 mm

yeni**450
lümen**

5000cd

Işık Şiddeti



141 m

Aydınlatma



12 h

Çalışma Süresi



Kolay Focus



Düşmeye Dayanıklı



IPX4



USB Tip C

R.P5R

Şarjlı El Feneri (Focus Özellikli)

Samsung LED
MOD Düşük/Orta/Yüksek
Işık gücü 20/150/450 lümen
Çalışma süresi 12s-4s-3s
880 mAh Li-Ion pil (14500),
Pil seviye göstergesi
Aydınlatma mesafesi 141 m
Işık şiddeti 5000cd
YxGxD: 113 x Ø35 x Ø26 mm

14 Genel Bakım ve Atölye Aletleri



yeni
tasarım



1000
lümen



R.P7R

Şarjlı El Feneri (Focus)

Samsung LED
MOD Düşük/Orta/Yüksek
Işık gücü 20/250/1000 lümen
Çalışma süresi 35s-5s-2.5s
2600 mAh Li-Ion pil (18650)
Aydınlatma mesafesi 89 m
Işık şiddeti 8000cd
Şarj süresi: 3.5s
Pil seviye göstergesi
YxGxD: 154 x Ø35 x Ø26 mm

yeni



900
lümen



R.L7R

Şarjlı El Feneri (Focus) UV Özellikli

Samsung LED
MOD Düşük/Orta/Yüksek/UV
Işık gücü 90/400/900 lümen
Çalışma süresi 20s-4s-3s
2600 mAh Li-Ion pil (18650)
Aydınlatma mesafesi 134 m
Işık şiddeti 2000cd
Şarj süresi: 3.5s
Pil seviye göstergesi
YxGxD: 159 x Ø35 x Ø26 mm

LU-MAX

LED El Fenerleri

Sağlam, kompakt ve güçlü el feneri serisi

Çoğu modelde odaklanmış ışık sağlayan zoom özelliği mevcuttur. Alüminyum modeller yüksek askeri kalite malzemeden; plastik modeller darbeye dayanıklı plastiklerden üretilmiştir. Tüm modellerde kemer veya cep klipsi mevcuttur.

**105**
lümen

Kolay Focus

R11-PRO**Profesyonel LED El Feneri**

3W LED
10-105 lümen
Alüminyum gövde
Zoom özellikli
3xAAA pil (dahil)
Paket Adedi: 12
YxGxD: 136 x Ø26 x Ø30 mm

**100**
lümen

Kolay Focus

R11-PEN**Kalem Tipi LED Cep Feneri**

1W LED
100 lümen
Alüminyum gövde
Zoom özellikli
2xAAA pil (dahil değildir)
Paket adedi: 12
YxGxD: 150 x Ø16 x Ø17 mm

**70**
lümen

Kolay Focus

R11-MINI**LED Cep Feneri (Kompakt)**

1W LED
70 lümen
Alüminyum gövde
Zoom özellikli ~ 5 m
3xAAA pil (dahil değildir)
Paket Adedi: 12
YxGxD: 100 x Ø27 x Ø30 mm

14 Genel Bakım ve Atölye Aletleri

M01 Serisi

İki Kollu Çektirmeler



Kolların ters çevrilebilme özelliği ile iç ve dış çektirme olarak kullanılır

KOD NO	G mm	Y mm	İkili	FİYAT/TL
M01-0810	80	100	1	
M01-1310	130	100	1	
M01-1615	160	150	1	
M01-2015	200	150	1	
M01-2520	250	200	1	
M01-3520	350	200	1	

M01-S05

5 Parça İki Kollu Çektirme Takımı



KOD NO	İkili	FİYAT/TL
M01-S05	1	

5 PC: M01-0810, M01-1310, M01-1615, M01-2015, M01-2520

M05 Serisi

Üç Kollu Çektirmeler (Kendinden Merkezlemeli)



Otomatik merkezleme, dayanıklı mil

KOD NO	G mm	Y mm	İkili	FİYAT/TL
M05-1010	100	100	1	
M05-1616	160	160	1	

M10S Serisi

Düz Ayırıcı – (Dış Rulman Çektirme Tutucu Çeneleri)



Ayırıcı civata ve saplama vidalarının sıkıştırılması ile kapanır, M10P serisi ile kullanılır

KOD NO	Ø mm	İkili	FİYAT/TL
M10S-0460	4- 60	1	
M10S-0680	6- 80	1	
M10S-1011	10-110	1	

M20-KIT1

Rulman Çektirme Takımı



Set içerisinde bulunan yarım küre başlıklar sayesinde rulmanın iç bileziğinden yakalanarak çıkartılmasını sağlar. **Rulman Kodları :** 6004, 6010, 6200, 6205, 6300, 6304, 61812, 61816

KOD NO	Ø mm	İkili	FİYAT/TL
M20-KIT1	20-95	1	

R09B Serisi

Tesviyeci Mengenerleri



KOD NO	ÇENE GENİŞLİĞİ mm	KAPASİTE mm	İkili	FİYAT/TL
R09B-125	125	130	1	
R09B-150	150	155	1	
R09B-200	200	205	1	

R03K-NRC

Perçin Tabancası Takımı (Pop Perçin/Somun Perçin için)



Perçin Çapları	Perçin Çapları
2.4 - 3.2 - 4.0 - 4.8	M3 - M4 - M5 - M6

KOD NO	İkili	FİYAT/TL
R03K-NRC	1	

R01-STD/M10 4 PC: Pop perçin kafası
4 PC: Perçin somun civatası 4 PC: Perçin yataklama somunu
Adaptör somun İki ağız anahtar

R04K

Katlanır Kollu Perçin Tabancası Takımı (Pop Perçin/Somun Perçin için)



CANTA GxYxD (mm)
340 X220 X50

Perçin Çapları	Perçin Çapları
3.2 - 4.0 - 4.8 - 6.4	M4 - M5 - M6 - M8 - M10

Somun ve pop perçinler için, normal perçin penslerine göre daha kuvvetli, katlanabilir kollu perçin pensli komple set

KOD NO	İkili	FİYAT/TL
R04K	1	

İçerik:
Kollu perçin tabancası (1 ad.), İki ağız anahtar (3 ad.), Perçin kafası (5 ad.), Perçin kafası adaptör somunu (1 ad.), Perçin somun civatası (5 ad.), Perçin somun yataklama somunu (5 ad.), Perçin somun adaptörü (1 ad.)



R03K-M Serisi

Yedek Perçin Somun Civataları (R03K için)



KOD NO	M		FİYAT/TL
R03K-M03	M3	6•	
R03K-M04	M4	6•	
R03K-M05	M5	6•	
R03K-M06	M6	6•	

R03K-S Serisi

Yedek Perçin Yataklama Somunları (R03K-NRC için)



KOD NO	M		FİYAT/TL
R03K-S03	M3	6•	
R03K-S04	M4	6•	
R03K-S05	M5	6•	
R03K-S06	M6	6•	

R04K-M Serisi

Yedek Perçin Somun Civataları (R04K için)



KOD NO	M		FİYAT/TL
R04K-M04	M4	6•	
R04K-M05	M5	6•	
R04K-M06	M6	6•	
R04K-M08	M8	6•	
R04K-M10	M10	6•	

R04K-S Serisi

Yedek Perçin Yataklama Somunları (R04K için)



KOD NO	M		FİYAT/TL
R04K-S04	M4	6•	
R04K-S05	M5	6•	
R04K-S06	M6	6•	
R04K-S08	M8	6•	
R04K-S10	M10	6•	

R04K-AS

Perçin Somun Adaptörü (R04K için)



KOD NO		FİYAT/TL
R04K-AS	6•	

R03K-RTCCırcırlı Perçin Tabancası Takımı
(Somun Perçin/Kör Somun Perçin)**yeni****Kapasiteler:**Perçin somunları M4 - M12 alüminyum/çelik/paslanmaz çelik
Kör perçin saplamaları M5/M6/M8 alüminyum/çelik/paslanmaz çelik

KOD NO		FİYAT/TL
R03K-RTC	1	
M12		
M10		
M6		
M5		
M4		
M8		

R03K-PT

Perçin Pensi Adaptör Takımı (Elektrikli Aletler için)



Elektrikli ve havalı vidalama ve matkapları kolayca perçin aparatına dönüştürür, dayanıklı rulmanlar kullanılmıştır, tüm aksesuarları ile birlikte plastik kutuda sunulur

KOD NO		FİYAT/TL
R03K-PT	1	
Pop Perçin Adaptörü		
Somun Perçin Adaptörü		
3.2 - 4.0 - 4.8 - 6.4		
M4 - M5 - M6 - M8 - M10		

R01-STD

Perçin Tabancası (Yeni Jenerasyon)

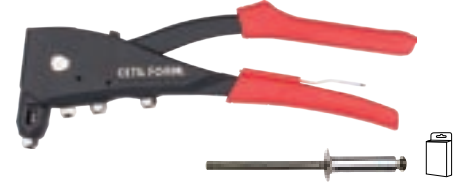

Alüminyum, çelik ve paslanmaz çelik perçinler için, değiştirilebilir perçin kafası

KOD NO	mm		FİYAT/TL
R01-STD	2.4 - 3.2 - 4.0 - 4.8	1	

R02-280

Perçin Tabancası (Döner Kafalı)

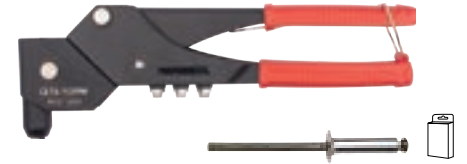

Alüminyum, çelik ve paslanmaz çelik perçinler için, 360° dönebilen kafa

KOD NO	mm		FİYAT/TL
R02-280	2.4 - 3.2 - 4.0 - 4.8	1	

R01-AS1

Perçin Pensi (Cherry Tip Perçinler için)



Özellikle havacılık endüstrisinde kullanılan, Cherry perçinler içindir, uzun burun, alüminyum gövde

KOD NO	mm	inch		FİYAT/TL
R01-AS1	2.4 - 3.2 - 4.0	3/32 - 1/8 - 5/32	1	

R15 Serisi

Mıknatıslı Parça Yakalamalar (Spiral Şaftlı)



Ulaşılmaz zor yerlerdeki metal parçaları yakalamak için, krom kaplı güçlü mıknatıslı esnek şaft, çift bileşenli ergonomik sap

KOD NO	g	mm		FİYAT/TL
R15-0500	500	510	6	
R15-1000	1000	510	6	
R15-1800	1800	510	6	
R15-3000	3000	510	6	

14 Genel Bakım ve Atölye Aletleri

R15-TM10

Teleskopik Mıknatıslı Parça Yakalama



Ulaşılması zor yerlerdeki küçük metal parçaları yakalamak için, güçlü mıknatıs, teleskopik gövde, klipsli

KOD NO	g	mm		FİYAT/TL
R15-TM10	1000	150-675	25	

R15-HTM

Teleskopik Mıknatıslı Parça Yakalama



Ulaşılması zor yerlerdeki küçük metal parçaları yakalamak için, güçlü mıknatıs, teleskopik gövde, kaymayı önleyici vinil kaplama

KOD NO	g	mm		FİYAT/TL
R15-HTM	1600	425-680	12	

R15-NTM

Teleskopik Mıknatıslı Parça Yakalama (Silecek İğneli)



Ulaşılması zor yerlerdeki küçük metal parçaları yakalamak için, güçlü mıknatıs, silecek ayarı için iğne, teleskopik gövde, klipsli

KOD NO	mm		FİYAT/TL
R15-NTM	150-675	25	

R16-700

Mıknatıslı Makinist Parmağı (Esnek Gövde)



Ulaşılması zor yerlerdeki metal ve metal olmayan parçaları yakalamak için, mıknatıslı ve açılıp kapanabilen kışkaç ucu, esnek şaftlı gövde

KOD NO	g	mm		FİYAT/TL
R16-700	500	700	25	

R20R

Teleskopik Yuvarlak Ayna (L)



Metal çerçeveli cam ayna, oynar başlık, paslanmaz çelik teleskopik gövde, açık pozisyonda 900 mm uzunluk

KOD NO	mm	mm		FİYAT/TL
R20R	50	250-900	25	

R20RS

Teleskopik Yuvarlak Ayna (M)



Metal çerçeveli cam ayna, oynar başlık, paslanmaz çelik teleskopik gövde, açık pozisyonda 520 mm uzunluk

KOD NO	mm	mm		FİYAT/TL
R20RS	32	180-520	25	

R20S

Teleskopik Kare Ayna



Metal tabanlı ayna, oynar başlık, paslanmaz çelik teleskopik gövde, açık pozisyonda 725 mm uzunluk

KOD NO	G x Y mm	mm		FİYAT/TL
R20S	45x63	230-725	25	

R20RP

İzoleli Yuvarlak Ayna



Metal çerçeveli cam ayna, 45° açılı sabit başlık, izoleli paslanmaz çelik gövde

KOD NO	mm	mm		FİYAT/TL
R20RP	30	175	12	

R21P

Cep Büyütücü (3 Kademe)

yeni



KOD NO	GxYxD mm		FİYAT/TL
R21P	66 x39x18	1	

R08-500

Gres Pompası (El Tipi-Metal Uçlu)



400 bar basınç, metal borulu, elektrostatik mat toz boyalı çelik sac gövde

KOD NO	CC	mm		FİYAT/TL
R08-500	500	300	1	

R08-500SN

Gres Pompası Ucu (R08-500 için)



4 kışkaçlı konnektör, M10 x 1.0 mm bağlantı dişli

KOD NO	mm		FİYAT/TL
R08-500SN	38	6•	

R08-FS Serisi

Yedek Hortum Uçları (R08-500 için)



250 bar basınca dayanıklı esnek hortum, uçlar M10 x 1.0 mm bağlantı dişli

KOD NO	mm		FİYAT/TL
R08-FSN	330	6•	
R08-FSY	300	6•	

R05 Serisi

Metal Yağdanlıklar (Metal Uçlu)



Metal borulu, elektrostatik mat toz boyalı çelik sac gövde

KOD NO	CC		FİYAT/TL
R05-200	200	12 •	
R05-300	300	12 •	
R05-500	500	12 •	
R05-1000	1000	6 •	

R18S

Manyetik Parça Kabı (Dikdörtgen)



Paslanmaz Çelik



Vida, pul gibi parçaların montaj esnasında kaybolmaması için, güçlü mıknatıslı taban, paslanmaz çelik dikdörtgen gövde

KOD NO	GxYxD mm		FİYAT/TL
R18S	240x140x40	1	

R18R

Manyetik Parça Kabı (Yuvarlak)



Paslanmaz Çelik



Vida, pul gibi parçaların montaj esnasında kaybolmaması için, güçlü mıknatıslı taban, paslanmaz çelik yuvarlak gövde

KOD NO	Ø mm		FİYAT/TL
R18R	150	1	

R28-P0524





24 Parça M5 C-Coil Hasarlı Dış Onarım Takımı

KUTU GxYxD (mm)
245X125X40

M5

Hasarlı ve yıpranmış dişler için tamir seti (M5 dişler için)

KOD NO		FİYAT/TL
R28-P0524	1	

	M5x0.8		No. 8
	5.2 mm		No. 8
	M5x0.8 (20 ad.)		

R28-P1214





14 Parça M12 C-Coil Hasarlı Dış Onarım Takımı

KUTU GxYxD (mm)
245X125X40

M12

Hasarlı ve yıpranmış dişler için tamir seti (M12 dişler için)

KOD NO		FİYAT/TL
R28-P1214	1	







	M12x1.75		No.15
	12.4 mm		No.15
	M12x1.75 (10 ad.)		

R28S-P142020 Parça M14 C-Coil Hasarlı Dış Onarım Takımı
(Buji Yuvası için)KUTU GxYxD (mm)
245X125X40

M14

Hasarlı veya yıpranmış buji dişlerinin onarımı için kit, patentli yerleştirme tırnağı, yüksek kaliteli Krom Nikel paslanmaz çelik diş dişler, HSS matkap kılavuzu

KOD NO		FİYAT/TL
R28S-P1420	1	

	M14x1.25		
	No. 8 - 3 parça montaj		
	2 mm L Allen Anahtar		
	R28-SC14/1 M14x1.25 h: 7.7 mm (5 pc)		
	R28-SC14/2 M14x1.25 h: 11.0 mm (5 pc)		
	R28-SC14/3 M14x1.25 h: 15.0 mm (5 pc)		

R28-SC Serisi

C-Coil Hasarlı Dış Onarım Yayı - 10'lü Paket

Yüksek kalite Krom Nikel paslanmaz çelik malzemeden üretilmiştir, aşınma ve paslanmaya karşı yüksek dayanım
Belirtilen fiyatlar 10'lü paket fiyatlarıdır

KOD NO	M	h mm		FİYAT/TL
R28-SC08	M8	1.25	1 pk.	
R28-SC14/1	M14	1.25	7.7	1 pk.

R25-P05

5 Parça Ters Kılavuz Takımı



Kırılmış civata ve vidaların sökümü için, özel sol helisel kılavuz takımı, Krom Molibden çeliği

KOD NO		FİYAT/TL
R25-P05	6	

5 PC: 7/64" (3-6 mm), 9/64" (6-8 mm), 5/32" (8-11 mm), 1/4" (11-14 mm), 19/64" (14-18 mm)

R26A-B05

5 Parça Kırık Civata Çıkarma Takımı - SAE



Kırılmış civata ve vidaların sökümü için, kılavuz tutucu veya anahtar ile kullanılır

KOD NO		FİYAT/TL
R26A-B05	1	

5 PC: 1/8, 3/16, 15/64, 5/16, 3/8 inch

14 Genel Bakım ve Atölye Aletleri

R26-M25

25 Parça Kırık Cıvata Çıkarma Kiti

Yeni
tasarım

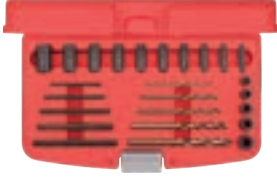

KUTU BxYxD (mm)
245X129X40

Kırılmış cıvata ve vidaların sökümü için komple takım, HSS uçlar, özel alet çeliğinden üretilmiş yardımcı parçalar



YouTube Clip

Uygulama:

M5, M6, M7, M8 (2 pc.), M9, M10, M11, M12, M14, M16 cıvatalar için

KOD NO	FİYAT/TL
R26-M25	1

R30 Serisi

1/2" Saplama Sökme Lokmaları



12.5
1/2"

Sağ ve sol dişli saplamaların sökülüp takılması için, silindirik tipi

KOD NO	M	mm	FİYAT/TL
R30-06	M6	60	25
R30-08	M8	60	25
R30-10	M10	69	25
R30-12	M12	69	25

R30-R04

4 Parça 1/2" Saplama Sökme Lokma Takımı



KOD NO	FİYAT/TL
R30-R04	6

4 PC: M6, M8, M10, M12

R21-P19

19 Parça HSS Matkap Ucu Takımı



Yüksek kaliteli HSS matkap uçları, 118° standart uç açısı

KOD NO	FİYAT/TL
R21-P19	1

19 PC: 1.0, 1.5, 2.0, 2.5, 3.0, 3.5, 4.0, 4.5, 5.0, 5.5, 6.0, 6.5, 7.0, 7.5, 8.0, 8.5, 9.0, 9.5, 10.0 mm

R32 Serisi

Spiral Lokma Anahtarlar (Aşınmış Cıvatalar İçin)



Ciddi derecede aşınmış cıvataların bile sökülmesine imkan veren özel lokma, spiral lokma profili

10
3/8" 8-19 mm
12.5
1/2" 21-27 mm



YouTube Clip

KOD NO	Ømm	mm	FİYAT/TL
R32-08	8	27.5	12
R32-10	10	27.5	12
R32-11	11	27.5	12
R32-12	12	27.5	12
R32-13	13	27.5	12
R32-14	14	27.5	12
R32-15	15	27.5	12
R32-16	16	27.5	12
R32-17	17	27.5	12
R32-18	18	27.5	12
R32-19	19	27.5	12
R32-21	21	27.5	12
R32-22	22	27.5	12
R32-24	24	27.5	12
R32-27	27	27.5	12

R32-P11

11 Parça 3/8" Spiral Lokma Takımı (Aşınmış Cıvatalar İçin)



10
3/8"

KOD NO	FİYAT/TL
R32-P11	6



9 PC: R32 (8, 10, 11, 12, 13, 14, 16, 17, 19 mm)

Pim

BT/7020 3/8"x 50 mm

R36-1

Düz Uçlu Biz



Paslanmaz Çelik

KOD NO	mm	FİYAT/TL
R36-1	80	6•

R36-2

Açılı Uçlu Biz



Paslanmaz Çelik

KOD NO	mm	FİYAT/TL
R36-2	80	6•

R36-3

90° Uçlu Biz



Paslanmaz Çelik

KOD NO	mm	FİYAT/TL
R36-3	80	6•

R36-4

Kanca Uçlu Biz



Paslanmaz Çelik

KOD NO	mm	FİYAT/TL
R36-4	80	6•

R36-B04

4 Parça Biz Takımı



Paslanmaz Çelik

KOD NO	FİYAT/TL
R36-B04	1



R36-1

R36-2



R36-3

R36-4

R37-25

Conta Kazıma Aleti



KOD NO	mm	mm		FİYAT/TL
R37-25	25	150	6	

CM-B0

Şişe Açacağı



KOD NO	mm		FİYAT/TL
CM-B0	145	12	

R35DE

Çift Uçlu Metal Çizecek



KOD NO	mm		FİYAT/TL
R35DE	235	1	

R35CT

Karbür Uçlu Metal Çizecek



KOD NO	mm		FİYAT/TL
R35CT	145	20	

R40-4

Plastik Saplı Tel Fırça (4 Sıra Telli)



KOD NO	mm		FİYAT/TL
R40-4	275	12 •	

R41-1

Plastik Saplı Tel Fırça



KOD NO	mm		FİYAT/TL
R41-1	245	12 •	

15 Teşhir Üniteleri

KOD NO / ÜRÜN TANIMI	FİYAT/TL
SK10-1-54 54 Parça C-PLUS T Saplı Allen Anahtar Teşhir Standı	
SC22H-1-184 184 Parça 1/2" 6 Köşe Lokma Anahtar Teşhir Standı	
SF10-1-067 67 Parça C-PLUS Tornavida Teşhir Standı (Düz/PH/PZ)	
SF10-1-067P 67 Parça C-PLUS Tornavida Teşhir Standı (Düz/PZ/PH)	
SF18-1-071 71 Parça C-PLUS Tornavida Teşhir Standı (TORX)	
S4000M-1-067 67 Parça TOREX Tornavida Teşhir Standı (Düz/PH/PZ)	
S4000M-1-067P 67 Parça TOREX Tornavida Teşhir Standı (Düz/PZ/PH)	
SCB-1-1008 1008 Parça Bits Uç Teşhir Standı (Düz/PH/PZ/TORX)	
SE11-1-040 40 Parça Pense Teşhir Standı (Parlak Kromlu/DuoTech Sap)	
SE41-1-040 40 Parça Pense Teşhir Standı (Polisajlı/DuoTech Sap)	
SE43-1-040 40 Parça Pense Teşhir Standı (Polisajlı/UniGrip Sap)	

KOD NO / ÜRÜN TANIMI	FİYAT/TL
SG01-1-067 67 Parça C-PLUS VDE 1000V Tornavida Teşhir Standı (Düz/PH/PZ)	
SG01-1-067P 67 Parça C-PLUS VDE 1000V Tornavida Teşhir Standı (Düz/PZ/PH)	
SG18-1-040 40 Parça VDE 1000V İzoleli Pense Teşhir Standı	
SH99-1-080 80 Parça Elektronikçi Tornavida Teşhir Standı (Düz/PH/TORX)	
SH20-1-040 40 Parça Elektronikçi Pense Teşhir Standı	
SJ72-1-60 60 Parça Eğe Teşhir Standı	
SP05-0316-180 180 Parça Kompakt Şerit Metre Teşhir Ünitesi (P05-0316)	
SP05-0516-120 120 Parça Kompakt Şerit Metre Teşhir Ünitesi (P05-0516)	
SP05-0519-120 120 Parça Kompakt Şerit Metre Teşhir Ünitesi (P05-0519)	
SP05-0525-108 108 Parça Kompakt Şerit Metre Teşhir Ünitesi (P05-0525)	
SP21-54 54 Parça Alüminyum Su Terazisi Teşhir Standı	

Yeni Mağazacılık Programı Kataloğu

- Ocak 2024'ten itibaren



Katalogumuzun 15. bölümünü oluşturan Teşhir Üniteleri bu katalogtan çıkarılmıştır ve yakında ayrı bir katalog olarak sunulacaktır.

Yeni mağazacılık katalogumuzda yer alacak çarpıcı tasarımı yeni teşhir üniteleri, müşterilerimizin satış noktalarının bir çekim merkezi haline getirilmesini sağlayacaktır.

STOKTAN KALKAN	2023-1 FİYAT TL	YERİNE GEÇEN	SAYFA NO
B10-0810		B09-0810	39
C01-60S		C01-60	53
C22A-B09/2		İPTAL	-
C31-14		C31-12-2	69
C52-H08		İPTAL	-
C62-B30		İPTAL	-
F23-100-150		İPTAL	-
BT/01TM		BT/01QH	96
F26/SGBT		F26/LBT	97
E50-16-0140		E50-140-2	104
E50-16-0190		E50-190-2	104
E53-16-0280		E53-280-2	104
N14-01S27		İPTAL	-
N23-0811G		N23-0812G	155
R15-MPL		İPTAL	-
R28-SC05		İPTAL	-
R28-SC06		İPTAL	-
R28-SC10		İPTAL	-
R28-SC12		İPTAL	-

KOD DEĞİŞİKLİKLERİ		
ESKİ KOD	YENİ KOD	SAYFA NO
C40-15MH2	C40-15MB2	70
F13-040-025	F10-040-025	77
F13-055-025	F10-055-025	77
F13-065-025	F10-065-025	77
F16-001-025	F14-001-025	77
F16-002-025	F14-002-025	77
R10-MAX1	R10-MAX01	165
R10-MAX2	R10-MAX02	165

ÜRETİMDEN KALKAN ÜRÜNLERE AİT YEDEK PARÇALAR		
YEDEK PARÇA	AÇIKLAMA	FİYAT
C01-14R	C01-14 için	
C11-14R	C11-14 için	
C21-14R	C21-14 için	
C31-12R	C31-12 için	
C31-14R	C31-14 için	
D02F-01R	D02F-0125 için	
D02F-11R	D02F-11 Serisi için	
D02F-21R	D02F-21 Serisi için	
E62-250R2	E62-250 için	
E62-280R2	E62-280 için	
I21-63R	I21-63 için	

YERİNE GEÇEN

TAVSİYE EDİLENLER



CETA FORM
QUALITY



İNDEKS

ÜRÜN KODU	FIYAT TL	SAYFA NO	ÜRÜN KODU	FIYAT TL	SAYFA NO	ÜRÜN KODU	FIYAT TL	SAYFA NO	ÜRÜN KODU	FIYAT TL	SAYFA NO	ÜRÜN KODU	FIYAT TL	SAYFA NO
705	45		1304M	82		4400/T27M	82		A01M-08	4		AS0CR-350A01T	32	
706	45		1305M	82		4400/T30M	82		A01M-08J	4		AS0CR-350T	32	
707	45		1306M	82		4400/T40M	82		A01M-CH	6		AS0EV-132	34	
708	45		1307M	82		4400M/6ST1	83		A01M-DH	7		AS0EV-132A01	34	
709	45		1308M	82		4400M-E701	24		A01M-LD	6		AS0EV-132A01M	34	
710	45		1309M	82		6105CP	111		A01M-PR	6		AS0M-43	11	
715	45		1310M	82		6106CP	111		A01-PL	6		AS0M-43A25	11	
720	45		1311M	82		6106EX	111		A01-PM	6		AS0M-43A27	11	
725	45		1312M	82		705L	45		A01-PM/J	7		AS0M-43A32	11	
727	45		1313M	82		706L	45		A01-PM/S	7		AS0M-43A32H	11	
730	45		1314M	82		707L	45		A01-PM/W	7		AS0M-80PH4	11	
740	45		1355M	82		708L	45		A01-PM/XL	7		AS0M-98A07	10	
745	45		29100D	163		709B	46		A01-PS	6		AS0MB-319A01MT	33	
750	45		3100/BT1	96		709IPR	46		A02-04	5		AS0MB-319A01T	33	
802	43		3100/BT6A	96		709L	45		A02-05	5		AS0MB-319T	33	
803	43		3100/TF2	84		709TL	46		A02-06	5		AS0TK-121A01T	27	
804	43		4000M/4ST4	82		710B	46		A02-ID	5		AS0TK-121A02T	27	
805	43		4000M/5ST1	82		710IPR	46		A03-SD	5		AS0TK-121T	27	
806	43		4000M/5ST3	82		710L	45		A06-04	8		AS0TK-123A01T	27	
807	43		4000M/6ST1	83		710TL	46		A06-04JS	8		AS0TK-123A02T	27	
808	43		4000M/6ST2	83		715B	46		A06-08JX	8		AS0TK-123T	27	
810	43		4000M/7ST1	83		715IPR	46		A06-CT	8		AS0TK-164A01T	28	
812	43		4000M/7ST2	83		715L	45		A07-02	8		AS0TK-164A02T	28	
814	43		4000M/9ST1	83		715TL	46		A07-03	8		AS0TK-164T	28	
815	43		4000M-E701	24		720B	46		A07-0301	8		AS0TK-230	29	
817	43		4100/107M	82		720IPR	46		A17D-G	5		AS0TK-230A01	29	
819	43		4100/21M	82		720L	45		A17D-GP	5		AS0TK-230A01M	29	
825	43		4100/31M	82		720TL	46		A17D-S	5		AS0TK-230A02	29	
835	43		4100/32M	82		725B	46		A17D-SP	5		AS0TK-232/1A01MT	28	
902	43		4100/35M	82		725IPR	46		A17D-W	5		AS0TK-232/1A01T	28	
903	43		4100/41M	82		725L	45		A17D-WP	5		AS0TK-232/1A02T	28	
904	43		4100/42M	82		725TL	46		A17H-D50	6		AS0TK-232/1T	28	
905	43		4100/43M	82		727B	46		A17H-S25	6		AS0TK-232/2	29	
906	43		4100/44M	82		727IPR	46		A17H-S50	6		AS0TK-232/2A01	29	
907	43		4100/52M	82		727L	45		A17L-NG	5		AS0TK-232/2A01M	29	
908	43		4100/53M	82		727TL	46		A17L-NS	5		AS0TK-232/2A02	29	
910	43		4100/54M	82		730B	46		A17L-NW	5		AS0TK-275A01MT	30	
912	43		4100/56M	82		730IPR	46		A20-100	6		AS0TK-275A01T	30	
915	43		4100/62M	82		730L	45		A20-110SH	6		AS0TK-275T	30	
925	43		4100/63M	82		730TL	46		A20-170	6		AS0TK-343A01MT	30	
935	43		4100/64M	82		740/M05	46		A20-200SH	5		AS0TK-343A01T	30	
6105	111		4100/66M	82		740/M06	46		A25-5	8		AS0TK-343T	30	
6106	111		4100/74M	82		740/M08	46		A25-5L	8		AS0VW-292	32	
29110	163		4100/75M	82		740/M10	46		A26-BP01	9		AS0VW-292A01	32	
29120	163		4100/86M	82		740/M12	46		A26-ET01	9		AS0VW-292A01M	32	
80050	44		4100/87M	82		740/M14	46		A26-IT01	9		AE00	26	
80104	44		4100/TP40M	82		740B	46		A26-PB01	9		A-SH	7	
80108	44		4100/TP55M	82		740IPR	46		A26-TB12	9		A-SL	7	
80116	44		4100/TP65M	82		740L	45		A26-TB19	9		A-STR-4045	7	
80308	44		4200/106M	82		740TL	46		A27-16PL	8		A-SW100	7	
80316	44		4200/30M	82		745L	45		A27-19PL	8		A-SW100F	7	
80332	44		4200/31M	82		8000/PH3	84		A27-22PL	8		A-SW100S	7	
80516	44		4200/51M	82		8000Q/M15	84		A27J-28	9		A-SW100SB	7	
80532	44		4200/52M	82		8002QH	84		A32	9		A-SW125	7	
80564	44		4200/53M	82		8101Q	84		A32/T	9		A-SW125F	7	
80732	44		4200/56M	82		8102Q	84		A32H	9		A-SW125S	7	
80764	44		4200/62M	82		8246Q	84		A50AS-159A07	10		A-SW125SB	7	
80964	44		4200/63M	82		8312Q	84		A50AS-197	31		A-SWJ-01M	7	
90050	45		4200/64M	82		8412Q	84		A50AS-197A01	31		A-SWS-01M	7	
90104	45		4200/66M	82		8515Q	84		A50AS-197A01M	31		B01-05/2	36	
90108	45		4200/84M	82		8525Q	84		A50BMW-321A01MT	33		B01-06	36	
90116	45		4200/TP1M	82		A01-06	4		A50BMW-321A01T	33		B01-07	36	
90308	45		4200/TP2M	82		A01-06W	4		A50BMW-321T	33		B01-08	36	
90316	45		4300/30M	82		A01-06WW	4		A50BR-153	35		B01-09	36	
90332	45		4300/51M	82		A01-07	4		A50BR-153A01	35		B01-10	36	
90516	45		4300/62M	82		A01-07J	4		A50BR-153A01M	35		B01-11	36	
90532	45		4300/84M	82		A01-08	4		A50BR-84	34		B01-12	36	
90564	45		4300/TP1M	82		A01-08J	4		A50BR-84A01	34		B01-13	36	
90732	45		4300/TP2M	82		A01-11	4		A50BR-84A01M	34		B01-14	36	
90764	45		4400/T10M	82		A01-11W	4		A50CR-293	31		B01-15	36	
90964	45		4400/T15M	82		A01M-06	4		A50CR-293A01	31		B01-16	36	
1300M/5ST1	83		4400/T20M	82		A01M-07	4		A50CR-293A01M	31		B01-17	36	
1300M-ES01	25		4400/T25M	82		A01M-07J	4		A50CR-350A01MT	32		B01-18	36	

İNDEKS

ÜRÜN KODU	FİYAT TL	SAYFA NO	ÜRÜN KODU	FİYAT TL	SAYFA NO	ÜRÜN KODU	FİYAT TL	SAYFA NO	ÜRÜN KODU	FİYAT TL	SAYFA NO	
B01-19	36		B05-17	37		B09-1617	39		B10-3032	38	B23-55	41
B01-20	36		B05-18	37		B09-1719	39		B10-B06	38	B23-60	41
B01-21	36		B05-19	37		B09-1819	39		B10-B08	38	B23-65	41
B01-22	36		B05-21	37		B09-1922	39		B10-B10	38	B23-70	41
B01-23	36		B05-22	37		B09-2022	39		B10-B10/2	38	B23-75	41
B01-24	36		B05-24	37		B09-2123	39		B10-B12	38	B23-80	41
B01-25	36		B05-27	37		B09-2224	39		B10-E08	21	B23-85	41
B01-26	36		B05-30	37		B09-2426	39		B10-E12	21	B23-90	41
B01-27	36		B05-32	37		B09-2427	39		B10-P12	39	B23-95	41
B01-28	36		B05-36	37		B09-2528	39		B10-R08	38	B24-100	41
B01-30	36		B05-38S	38		B09-2732	39		B10-R12	38	B24-24	41
B01-32	36		B05AR-0102	38		B09-3032	39		B14-0607	40	B24-27	41
B01-34	36		B05AR-0104	38		B09-3236	39		B14-0809	40	B24-30	41
B01-36	36		B05AR-0304	38		B09-3336	39		B14-1011	40	B24-32	41
B01-38	36		B05AR-0308	38		B09-3641	39		B14-1213	40	B24-36	41
B01-41	36		B05AR-0508	38		B09-4146	39		B14-1415	40	B24-41	41
B01-46	36		B05AR-0516	38		B09-4650	39		B14-1617	40	B24-46	41
B01-50	36		B05AR-0716	38		B09A-0102	39		B14-1819	40	B24-50	41
B01A-00102	37		B05AR-0732	38		B09A-0203	39		B14-2022	40	B24-55	41
B01A-00104	37		B05AR-0916	38		B09A-0304	39		B14-2123	40	B24-60	41
B01A-00304	37		B05AR-0932	38		B09A-0405	39		B14-2426	40	B24-65	41
B01A-00308	37		B05AR-1116	38		B09A-0506	39		B14-2427	40	B24-70	41
B01A-00508	37		B05AR-1132	38		B09A-0607	39		B14-2528	40	B24-75	41
B01A-00516	37		B05-E12	21		B09A-0708	39		B14-3032	40	B24-80	41
B01A-00708	37		B05-P12	37		B09A-0709	39		B14-3641	40	B24-90	41
B01A-00716	37		B05-R05	37		B09A-0809	39		B14-B06	40	B24-95	41
B01A-00916	37		B05R-09	37		B09A-0810	39		B14-B08	40	B27-2022	41
B01A-00932	37		B05R-11	37		B09A-0911	39		B14-B10/2	40	B27-2123	41
B01A-01116	37		B05-R12	37		B09A-1011	39		B14-B12	40	B27-2224	41
B01A-01132	37		B05R-12	37		B09A-1213	39		B14-E08	21	B27-2426	41
B01A-01316	37		B05R-14	37		B09A-1315	39		B14-R08	40	B27-2427	41
B01A-01516	37		B05R-15	37		B09A-1415	39		B14-R12	40	B27-2528	41
B01A-10000	37		B05R-16	37		B09A-1417	39		B17-0608	40	B27-2B	41
B01A-10102	37		B05R-18	37		B09A-R10	39		B17-1012	40	B27-3032	41
B01A-10104	37		B05-S04	38		B09-B06	39		B17-1418	40	B27T-0607	41
B01A-10108	37		B06-08	37		B09-B08	39		B17-2024	40	B27T-06B	41
B01A-10116	37		B06-09	37		B09-B10	39		B17-B04	40	B27T-0809	41
B01A-10308	37		B06-10	37		B09-B10/2	39		B17-E18	21	B27T-08B	41
B01A-10316	37		B06-11	37		B09-B12	39		B19-0810	40	B27T-1011	41
B01A-E14	21		B06-12	37		B09-E08	21		B19-0911	40	B27T-10B	41
B01A-R09	37		B06-13	37		B09-E12	21		B19-1011	40	B27T-1213	41
B01A-R14	37		B06-14	37		B09-P12	39		B19-1113	40	B27T-12B	41
B01A-R16	37		B06-15	37		B09-R08	39		B19-1214	40	B27T-1415	41
B01AS-00108	36		B06-16	37		B09-R12	39		B19-1719	40	B27T-14B	41
B01AS-00316	36		B06-17	37		B09SA-0102	39		B19-1922	40	B27T-1617	41
B01AS-00532	36		B06-18	37		B09SA-0104	39		B19-2427	40	B27T-16B	41
B01AS-00732	36		B06-19	37		B09SA-0308	39		B19-B06	40	B27T-1819	41
B01AS-00732B	36		B06-E12	21		B09SA-0516	39		B20-1012	40	B27T-2022	41
B01-B08	36		B06-R05	37		B09SA-0716	39		B20-1113	40	B27T-2123	41
B01-B12	36		B06-R12	37		B09SA-0732	39		B20-1315	40	B27T-2426	41
B01-B12/2	36		B07A-0102	38		B09SA-0916	39		B20-1317	40	B27T-2528	41
B01-B17	36		B07A-0203	38		B09SA-0932	39		B20-1417	40	B27T-3032	41
B01-B21	36		B07A-0304	38		B09SA-1132	39		B20-1922	40	B27T-B08	41
B01-B25	36		B07A-0506	38		B09SA-1564	39		B21-150B	41	B27T-B12	41
B01-E12	21		B07A-B04	38		B09SA-R09	39		B21-150C	41	B28-06	42
B01-E16	21		B07AO-0102	38		B10-0607	38		B21-200B	41	B28-07	42
B01-E21/2	13		B07AO-0203	38		B10-0809	38		B21-200C	41	B28-08	42
B01-P12	36		B07AO-0304	38		B10-1011	38		B21-250B	41	B28-09	42
B01-R12	36		B07AO-0506	38		B10-1013	38		B21-250C	41	B28-10	42
B01-R13	36		B07AO-B04	38		B10-1213	38		B21-300B	41	B28-11	42
B01-R21	36		B07-B01	37		B10-1317	38		B21-300C	41	B28-12	42
B05-08	37		B09-0555	39		B10-1415	38		B21-375B	41	B28-13	42
B05-09	37		B09-0607	39		B10-1617	38		B21-375C	41	B28-14	42
B05-10	37		B09-0809	39		B10-1719	38		B21W-200B	41	B28-15	42
B05-11	37		B09-0810	39		B10-1819	38		B23-100	41	B28-16	42
B05-12	37		B09-1011	39		B10-1922	38		B23-24	41	B28-17	42
B05-12S	38		B09-1012	39		B10-2022	38		B23-27	41	B28-18	42
B05-13	37		B09-1013	39		B10-2123	38		B23-30	41	B28-19	42
B05-14	37		B09-1213	39		B10-2224	38		B23-32	41	B28-22	42
B05-14B	38		B09-1214	39		B10-2426	38		B23-36	41	B28-B08	42
B05-14S	38		B09-1317	39		B10-2427	38		B23-41	41	B28-E08	21
B05-15	37		B09-1415	39		B10-2528	38		B23-46	41	B30-0810	42
B05-16	37		B09-1417	39		B10-2732	38		B23-50	41	B30-1011	42

İNDEKS

ÜRÜN KODU	FIYAT TL	SAYFA NO	ÜRÜN KODU	FIYAT TL	SAYFA NO	ÜRÜN KODU	FIYAT TL	SAYFA NO	ÜRÜN KODU	FIYAT TL	SAYFA NO	ÜRÜN KODU	FIYAT TL	SAYFA NO
B30-1213	42		BTA/010245	92		C02A-H0316	49		C08AS-H0108	51		C11-20	58	
B30-1415	42		BTA/010442	92		C02A-H0532	49		C08AS-H0116	51		C11-20S	58	
B30-1617	42		BTA/051642	92		C02A-RB10	49		C08AS-H0316	51		C11-36MR	58	
B30-1819	42		BTD/08	92		C02A-S0104	49		C08AS-H0332	51		C11-40	58	
B32-06	42		BTD/10	92		C02A-S0308	49		C08AS-H0516	51		C11-50MR	58	
B32-07	42		BTD/13	92		C02A-S0316	49		C08AS-H0532	51		C11-60	58	
B32-08	42		C00-15RH4	54		C02A-S0516	49		C08AS-H0564	51		C11-60S	59	
B32-09	42		C00-18PH2	55		C02A-S0716	49		C08AS-H0732	51		C11-72	59	
B32-10	42		C00-25RH4	54		C02A-S0732	49		C08AS-H0764	51		C11-72W	59	
B32-11	42		C00-27PH5	54		C02A-S0932	49		C08AS-H0964	51		C11-75	59	
B32-12	42		C00-46PH2	55		C02A-S1132	49		C08AS-RHX11	51		C11-75W	59	
B32-13	42		C00-61PH2	55		C02-H040	49		C08S-H25	51		C11-76F	59	
B32-14	42		C00A-15PBT	55		C02-H045	49		C08S-H30	51		C11-77	59	
B32-15	42		C00A-60PM2	55		C02-H050	49		C08S-H40	51		C11-78	59	
B32-16	42		C00A-E15BT	22		C02-H055	49		C08S-H50	51		C11-79	59	
B32-16S	146		C00A-E25BT	22		C02-H060	49		C08S-H60	51		C11-80	59	
B32-17	42		C00A-E39BT	23		C02-H070	49		C08S-H70	51		C11-91	59	
B32-18	42		C00C-E45BHT	23		C02-H080	49		C08S-H80	51		C11-92	59	
B32-19	42		C00-E26H2	22		C02-H090	49		C08S-IPR10	51		C11-92S	59	
B32-21S	146		C00-E52H2	22		C02-H100	49		C08S-IPR15	51		C11-C	59	
B99A-E26	13		C01-11	52		C02-H110	49		C08S-IPR20	51		C11-T90	58	
B99A-E31	13		C01-11R	53		C02-H120	49		C08S-IPR25	51		C11-T90R	58	
B99-E20T	20		C01-12	52		C02-H130	49		C08S-IPR27	51		C12A-B0102	56	
B99-E24T	13		C01-12R	53		C02-H140	49		C08S-IPR30	51		C12A-B0104	56	
B99-E24T	13		C01-14N	52		C02-H150	49		C08S-IPR40	51		C12A-B0304	56	
B99-E32T	13		C01-14NR	53		C02-RH13	49		C08S-PH1	50		C12A-B0308	56	
B99-E41T	12		C01-15	52		C02UA-0102	50		C08S-PH2	50		C12A-B0508	56	
BC-E08	13		C01-20	53		C02UA-0104	50		C08S-PH3	50		C12A-B0516	56	
BC-E081	13		C01-20F	53		C02UA-0308	50		C08S-PZ1	50		C12A-B0708	56	
BC-E40	14		C01-20S	53		C02UA-0516	50		C08S-PZ2	50		C12A-B0716	56	
BT/01DUO	96		C012-16	54		C02UA-0716	50		C08S-PZ3	50		C12A-B0916	56	
BT/01QH	96		C012-16	59		C02UA-0732	50		C08S-RHX7	51		C12A-B1000	56	
BT/01SL2	96		C012-16	65		C02UA-0916	50		C08S-RTP7	51		C12A-B1116	56	
BT/01XF	97		C012-19	54		C02UA-0932	50		C08S-RTR7	51		C12A-B1316	56	
BT/02	96		C012-19	59		C02UA-1132	50		C08S-RTX7	51		C12A-B1516	56	
BT/03	96		C012-19	65		C02UA-RB09	50		C08S-S40	50		C12A-RB13	56	
BT/05	96		C012-26	54		C04-10PH0	55		C08S-S55	50		C12A-S0102	56	
BT/0542	92		C012-26	59		C04A-B0102	50		C08S-S65	50		C12A-S0308	56	
BT/0642	92		C012-26	65		C04A-B0104	50		C08S-T06	51		C12A-S0508	56	
BT/0665	92		C012-34	54		C04A-B0308	50		C08S-T07	51		C12A-S0716	56	
BT/0742	92		C012-34	59		C04A-B0316	50		C08S-T08	51		C12A-S0916	56	
BT/0765	92		C012-34	65		C04A-B0516	50		C08S-T09	51		C12A-S1532	56	
BT/08	96		C01-35MR	53		C04A-B0716	50		C08S-T10	51		C12A-S1932	56	
BT/0842	92		C01-40	53		C04A-B0732	50		C08S-T15	51		C12-H06	56	
BT/0865	92		C01-50MR	53		C04A-B0916	50		C08S-T20	51		C12-H07	56	
BT/0865TM	85		C01-60	53		C04A-B0932	50		C08S-T25	51		C12-H08	56	
BT/1045	92		C01-71	54		C04A-B1132	50		C08S-T27	51		C12-H09	56	
BT/1065	92		C01-72	54		C04A-RB10	50		C08S-T30	51		C12-H10	56	
BT/1065TM	85		C01-73	54		C04-B08	50		C08S-T40	51		C12-H11	56	
BT/1165	92		C01-73W	54		C04-B10	50		C08S-TR08	51		C12-H12	56	
BT/1265	92		C01-75	54		C04-B13	50		C08S-TR09	51		C12-H13	56	
BT/1365	92		C01-75F	54		C04-H040	49		C08S-TR10	51		C12-H14	56	
BT/1365TM	85		C01-77	54		C04-H045	49		C08S-TR15	51		C12-H15	56	
BT/1465	92		C01-78	54		C04-H050	49		C08S-TR20	51		C12-H16	56	
BT/1765	92		C01-80	54		C04-H055	49		C08S-TR25	51		C12-H17	56	
BT/7000S3	95		C01-92	54		C04-H060	49		C08S-TR27	51		C12-H18	56	
BT/7010	95		C01-C	54		C04-H070	49		C08S-TR30	51		C12-H19	56	
BT/7015	95		C01-HLOK	52		C04-H080	49		C08S-TR40	51		C12-H20	56	
BT/7017M	95		C01-T90	52		C04-H090	49		C10-15PG1	59		C12-H21	56	
BT/7018	95		C01-T90L	52		C04-H100	49		C10-18PH4	60		C12-H22	56	
BT/7020	95		C01-T90LR	53		C04-H110	49		C10-20PH2	60		C12-RH10	56	
BT/7027	95		C01-T90R	53		C04-H120	49		C10-60PH2	60		C12U-RB10	57	
BT/7028	95		C02A-B0102	49		C04-H130	49		C10A-17PBT	60		C14A-B0102	56	
BT/7030	95		C02A-B0104	49		C04-H140	49		C10A-41PM2	60		C14A-B0104	56	
BT/8001	54		C02A-B0308	49		C04-RH08	50		C10A-E17BT	23		C14A-B0304	56	
BT/8003	59		C02A-B0316	49		C06-04	50		C10A-E30BT	23		C14A-B0308	56	
BT/8004	59		C02A-B0516	49		C06-05	50		C10-E18H2	23		C14A-B0508	56	
BT/8005	59		C02A-B0716	49		C06-06	50		C11-11	58		C14A-B0516	56	
BT/8007	65		C02A-B0732	49		C06-07	50		C11-11R	58		C14A-B0708	56	
BT/8007QR	73		C02A-B0916	49		C06-08	50		C11-12	58		C14A-B0716	56	
BT/8008	65		C02A-B0932	49		C06-10	50		C11-12R	58		C14A-B0916	56	
BT/8008QR	73		C02A-B1132	49		C06-R06	50		C11-14N	58		C14A-B1000	56	
BT/ST061	92		C02A-H0108	49		C08AS-H0104	51		C11-14NR	58		C14A-B1116	56	

İNDEKS

ÜRÜN KODU	FIYAT TL	SAYFA NO	ÜRÜN KODU	FIYAT TL	SAYFA NO	ÜRÜN KODU	FIYAT TL	SAYFA NO	ÜRÜN KODU	FIYAT TL	SAYFA NO			
C14A-B1316	56		C20A-E20BT		24	C22-H08		60	C26-24		61	C28S-T40L		62
C14A-B1516	56		C20-E23H2		23	C22-H09		60	C26-R08		61	C28S-T45		62
C14A-RB13	56		C21-11		64	C22-H10		60	C27-R16		146	C28S-T45L		62
C14-H08	56		C21-11R		64	C22-H11		60	C27-R16M		146	C28S-T50		62
C14-H09	56		C21-12		64	C22-H12		60	C27-R21		146	C28S-T50L		62
C14-H10	56		C21-12R		64	C22-H13		60	C27-R21M		146	C28S-T55		62
C14-H11	56		C21-14N		64	C22-H14		60	C28AS-H0102		63	C28S-T55L		62
C14-H12	56		C21-14NR		64	C22-H15		60	C28AS-H0104		63	C28S-T60		62
C14-H13	56		C21-20		64	C22-H16		60	C28AS-H0308		63	C28S-T60L		62
C14-H14	56		C21-38MR		64	C22-H17		60	C28AS-H0316		63	C28S-T70		62
C14-H15	56		C21-39MR		64	C22-H18		60	C28AS-H0508		63	C28S-T70L		62
C14-H16	56		C21-40		65	C22-H19		60	C28AS-H0516		63	C28S-TR30		62
C14-H17	56		C21-40L		65	C22-H20		60	C28AS-H0532		63	C28S-TR30XL		62
C14-H18	56		C21-50		65	C22-H21		60	C28AS-H0732		63	C28S-TR40		62
C14-H19	56		C21-60		65	C22-H22		60	C28AS-H0916		63	C28S-TR45		62
C14-RB10	56		C21-60S		65	C22-H23		60	C28AS-RH9		63	C28S-TR50		62
C14-RH10	56		C21-71W		65	C22-H24		60	C28S-17PTH		64	C28S-TR55		62
C15-RH10	57		C21-72		65	C22-H25		60	C28S-E14H		23	C28S-X05		63
C16-04	57		C21-74		65	C22-H26		60	C28S-E29		23	C28S-X06		63
C16-05	57		C21-74W		65	C22-H27		60	C28S-H04		62	C28S-X06L		63
C16-06	57		C21-77		65	C22-H28		60	C28S-H05		62	C28S-X08		63
C16-07	57		C21-77W		65	C22-H29		60	C28S-H05L		62	C28S-X08L		63
C16-08	57		C21-79W		65	C22-H30		60	C28S-H06		62	C28S-X10		63
C16-10	57		C21-80		65	C22-H32		60	C28S-H06L		62	C28S-X10L		63
C16-11	57		C21-90KIT15		66	C22-RB11		61	C28S-H06XL		62	C28S-X10XL		63
C16-12	57		C21-90KIT6		66	C22-RH11		61	C28S-H06XL2		62	C28S-X12		63
C16-14	57		C21-91		65	C24-B08		61	C28S-H07		62	C28S-X12L		63
C16-16	57		C21-91S		65	C24-B10		61	C28S-H07L		62	C28S-X12XL		63
C16-18	57		C21-92		65	C24-B11		61	C28S-H08		62	C28S-X14		63
C16-20	57		C21-C		65	C24-B12		61	C28S-H08L		62	C28S-X14L		63
C16D-08	57		C21-T90		64	C24-B13		61	C28S-H09		62	C28S-X16		63
C16D-10	57		C21-T90R		64	C24-B14		61	C28S-H09L		62	C30-14MB2		70
C16D-12	57		C22A-B03		61	C24-B15		61	C28S-H10		62	C30-14MH2		70
C16D-14	57		C22A-B04		61	C24-B16		61	C28S-H10L		62	C31-12-2		69
C16-R10	57		C22A-B05		61	C24-B17		61	C28S-H10XL		62	C31-12-2R		69
C17-R14C	146		C22A-B06		61	C24-B18		61	C28S-H11L		62	C31-40		69
C17-R14CF	146		C22A-B06/2		61	C24-B19		61	C28S-H12		62	C31-73		69
C17-R14ML	146		C22A-B07		61	C24-B20		61	C28S-H12L		62	C31-76		69
C17-R16	146		C22A-B08		61	C24-B21		61	C28S-H12XL		62	C31-78		69
C17-R18	146		C22A-B09		61	C24-B22		61	C28S-H13L		62	C31-91		69
C17-R21	146		C22A-B10		61	C24-B24		61	C28S-H14		62	C31-92		69
C18S-H03	57		C22A-B11		61	C24-B27		61	C28S-H14L		62	C32A-B11		69
C18S-H04	57		C22A-B12		61	C24-B30		61	C28S-H17		62	C32A-B12		69
C18S-H05	57		C22A-B13		61	C24-B32		61	C28S-H19		62	C32A-B13		69
C18S-H06	57		C22A-B14		61	C24-E13H		23	C28S-HB05XL		63	C32A-B14		69
C18S-H07	57		C22A-B15		61	C24-H08		61	C28S-HB06XL		63	C32A-B15		69
C18S-H08	57		C22A-B16		61	C24-H10		61	C28S-HB07XL		63	C32A-B17		69
C18S-H09	57		C22A-B17		61	C24-H11		61	C28S-HB08XL		63	C32A-B27		69
C18S-H10	57		C22A-RB11		61	C24-H12		61	C28S-HB10XL		63	C32-B22		69
C18S-RH08	57		C22-B08		60	C24-H13		61	C28S-R05L		63	C32-B24		69
C18S-RT09	57		C22-B09		60	C24-H14		61	C28S-R06L		63	C32-B27		69
C18S-T10	57		C22-B10		60	C24-H15		61	C28S-R08L		63	C32-B30		69
C18S-T15	57		C22-B11		60	C24-H16		61	C28S-R10L		63	C32-B32		69
C18S-T20	57		C22-B12		60	C24-H17		61	C28S-R12L		63	C32-B36		69
C18S-T25	57		C22-B13		60	C24-H18		61	C28S-R14L		63	C32-B38		69
C18S-T27	57		C22-B14		60	C24-H19		61	C28S-RH9		62	C32-B41		69
C18S-T30	57		C22-B15		60	C24-H20		61	C28S-RR6L		63	C32-B46		69
C18S-T40	57		C22-B16		60	C24-H21		61	C28S-RT9		62	C32-B50		69
C18S-T45	57		C22-B17		60	C24-H22		61	C28S-RX5L		63	C32-H19		69
C18S-T50	57		C22-B18		60	C24-H24		61	C28S-RX6		63	C32-H21		69
C18S-T55	57		C22-B19		60	C24-H27		61	C28-S540		64	C32-H22		69
C20-180PH2	68		C22-B20		60	C24-H30		61	C28-SSE40		24	C32-H24		69
C20-18PH2	66		C22-B21		60	C24-H32		61	C28S-T20		62	C32-H27		69
C20-18PTX	64		C22-B22		60	C24-RB09		61	C28S-T20L		62	C32-H30		69
C20-23PH4	66		C22-B23		60	C24-RH09		61	C28S-T25		62	C32-H32		69
C20-25PB2	66		C22-B24		60	C26-10		61	C28S-T25L		62	C32-H33		69
C20-25PH2	66		C22-B25		60	C26-11		61	C28S-T27		62	C32-H34		69
C20-35PH4	67		C22-B26		60	C26-12		61	C28S-T27L		62	C32-H36		69
C20-49PH2	67		C22-B27		60	C26-14		61	C28S-T30		62	C32-H38		69
C20-56PH2	67		C22-B28		60	C26-16		61	C28S-T30L		62	C32-H41		69
C20-96PH2	68		C22-B29		60	C26-18		61	C28S-T35		62	C32-H46		69
C20A-20PBT	67		C22-B30		60	C26-20		61	C28S-T35L		62	C32-H50		69
C20A-34PM2	67		C22-B32		60	C26-22		61	C28S-T40		62	C32-H55		69

İNDEKS

ÜRÜN KODU	FİYAT TL	SAYFA NO	ÜRÜN KODU	FİYAT TL	SAYFA NO	ÜRÜN KODU	FİYAT TL	SAYFA NO	ÜRÜN KODU	FİYAT TL	SAYFA NO	
C32-H60	69		C62-H32	71		C72-H21	73		C99-E79H2	16	CB/2106G	95
C385-H14	69		C62-H36	71		C72-H22	73		C99-E95H2	15	CB/2107G	95
C385-H17	69		C62-RH09	71		C72-H24	73		C99-E99H2	15	CB/2108G	95
C385-H19	69		C64-E10/2	24		C72-H27	73		CB/1020G	95	CB/2110G	95
C385-H22	69		C64F-1819	154		C72-H30	73		CB/1025G	95	CB/2112G	95
C40-15MB2	70		C64-H10	72		C72-H32	73		CB/1027G	95	CB/250	87
C41-12	70		C64-H11	72		C72-H33	73		CB/1030G	95	CB/251	87
C41-12/H	70		C64-H12	72		C72-H34	73		CB/1040G	95	CB/251B	87
C41-12/T	70		C64-H13	72		C72-H36	73		CB/1045G	95	CB/251TC	86
C41-12R	70		C64-H14	72		C72-H38	73		CB/1050G	95	CB/251TM	85
C41-40	70		C64-H15	72		C72-H41	73		CB/1055G	95	CB/251X	87
C41-40R	70		C64-H16	72		C72-H46	73		CB/1101	90	CB/252	87
C41-76	70		C64-H17	72		C72-H50	73		CB/1102	90	CB/252B	87
C41-78	70		C64-H17MB	154		C72-H55	73		CB/1103	90	CB/252BD	87
C41-91	70		C64-H18	72		C72-H60	73		CB/1120G	95	CB/252D	87
C42-B32	70		C64-H19	72		C74-H17	73		CB/1125G	95	CB/252DB	87
C42-B36	70		C64-H20	72		C74-H19	73		CB/1127G	95	CB/252TC	86
C42-B41	70		C64-H21	72		C74-H21	73		CB/1130G	95	CB/252TM	85
C42-B46	70		C64-H22	72		C74-H22	73		CB/1140G	95	CB/252X	87
C42-B50	70		C64-H23	72		C74-H24	73		CB/1145G	95	CB/253	87
C42-B55	70		C64-H24	72		C74-H27	73		CB/1150G	95	CB/253B	87
C42-B60	70		C64-H27	72		C74-H30	73		CB/1155G	95	CB/253TC	86
C42-B65	70		C64-H30	72		C74-H32	73		CB/1271	90	CB/253TM	85
C42-B70	70		C64-H32	72		C74-H33	73		CB/1272	90	CB/253X	87
C42-B75	70		C64-RH09	72		C74-H34	73		CB/1273	90	CB/254	87
C42-B80	70		C64W-H17	154		C74-H36	73		CB/1521	90	CB/262	87
C51R-72	71		C64W-H19	154		C74-H38	73		CB/1522	90	CB/3005G	95
C51R-80	71		C64W-H21	154		C74-H41	73		CB/1523	90	CB/3006G	95
C51R-91	71		C64W-P03	154		C74-H46	73		CB/180104	89	CB/3008G	95
C51R-92	71		C66-E10	72		C74-H50	73		CB/180108	89	CB/3010G	95
C52-H06	71		C66-E12	72		C81-75	74		CB/180316	89	CB/3012G	95
C52-H07	71		C66-E14	72		C81-77	74		CB/180332	89	CB/3105G	95
C52-H13	71		C66-E16	72		C81-91	74		CB/180532	89	CB/3106G	95
C52R-H08	71		C66-E18	72		C82-H24	74		CB/180732	89	CB/3108G	95
C52R-H10	71		C66-E20	72		C82-H27	74		CB/180964	89	CB/3110G	95
C52R-H11	71		C66-E22	72		C82-H30	74		CB/1810	89	CB/3112G	95
C52R-H12	71		C66-E24	72		C82-H32	74		CB/1815	89	CB/350	87
C52R-H13	71		C66-R08	72		C82-H33	74		CB/1815TC	86	CB/351	87
C52R-H14	71		C68-H05	72		C82-H34	74		CB/1820	89	CB/351B	88
C52R-H15	71		C68-H06	72		C82-H36	74		CB/1820TC	86	CB/351TC	86
C52R-H16	71		C68-H07	72		C82-H38	74		CB/1825	89	CB/351TM	85
C52R-H17	71		C68-H08	72		C82-H41	74		CB/1825TC	86	CB/351X	87
C52R-H18	71		C68-H10	72		C82-H46	74		CB/1830	89	CB/352	87
C52R-H19	71		C68-H12	72		C82-H50	74		CB/1830TC	86	CB/352B	88
C52R-RH10	71		C68-H14	72		C82-H55	74		CB/1835	89	CB/352BD	88
C61-72	73		C68-H17	72		C82-H60	74		CB/1840	89	CB/352D	87
C61-74	73		C68-H19	72		C82-H65	74		CB/1840TC	86	CB/352TC	86
C61-80	73		C68-RH07	72		C82-H70	74		CB/1850	89	CB/352TM	85
C61-90KIT7	73		C68-RT07	72		C82-H75	74		CB/1850TC	86	CB/352X	87
C61-91	73		C68-RX07	73		C82-H80	74		CB/1860	89	CB/353	87
C61-92	73		C68-T30	72		C84-H24	74		CB/1860TC	86	CB/353B	88
C62-B24	72		C68-T40	72		C84-H27	74		CB/1880	89	CB/353TC	86
C62-B32	72		C68-T45	72		C84-H30	74		CB/190316	92	CB/353TM	85
C62-B34	72		C68-T50	72		C84-H32	74		CB/190332	92	CB/353X	87
C62-B36	72		C68-T55	72		C84-H33	74		CB/190532	92	CB/354	87
C62-E10	24		C68-T60	72		C84-H34	74		CB/1915	92	CB/491	90
C62-H10	71		C68-T70	72		C84-H36	74		CB/1920	92	CB/491B	90
C62-H11	71		C68-T80	72		C84-H38	74		CB/1925	92	CB/491TC	86
C62-H12	71		C68-X06	73		C84-H41	74		CB/1930	92	CB/491TM	85
C62-H13	71		C68-X08	73		C84-H46	74		CB/1940	92	CB/491X	90
C62-H14	71		C68-X10	73		C84-H50	74		CB/1950	92	CB/492	90
C62-H15	71		C68-X12	73		C84-H55	74		CB/1960	92	CB/492B	90
C62-H16	71		C68-X14	73		C84-H60	74		CB/1980	92	CB/492BD	90
C62-H17	71		C68-X16	73		C84-H65	74		CB/2004G	95	CB/492D	90
C62-H18	71		C68-X18	73		C84-H70	74		CB/2005G	95	CB/492TC	86
C62-H19	71		C71-75	74		C84-H75	74		CB/2006G	95	CB/492TM	85
C62-H20	71		C71-77	74		C84-H80	74		CB/2007G	95	CB/492X	90
C62-H21	71		C71-80	74		C99A-E115BMR	17		CB/2008G	95	CB/493	90
C62-H22	71		C71-91	74		C99A-E96BMR	14		CB/2010G	95	CB/493B	90
C62-H23	71		C71-91R	74		C99-E114H2	16		CB/2012G	95	CB/493TC	86
C62-H24	71		C71-92	74		C99-E115H2	15		CB/2022	90	CB/493TM	85
C62-H27	71		C72-H17	73		C99-E68H2	14		CB/2104G	95	CB/493X	90
C62-H30	71		C72-H19	73		C99-E77H2	16		CB/2105G	95	CB/516HX05	94

İNDEKS

ÜRÜN KODU	FIYAT TL	SAYFA NO	ÜRÜN KODU	FIYAT TL	SAYFA NO	ÜRÜN KODU	FIYAT TL	SAYFA NO	ÜRÜN KODU	FIYAT TL	SAYFA NO	
CB/516HX06	94		CB/806IP	88		CB/826TM	85		CB/PH2M5	95	D02E-0E1415	76
CB/516HX07	94		CB/806IPR	88		CB/826X	91		CB/PH30H4	93	D02E-0E1416	76
CB/516HX08	94		CB/806T	88		CB/827	91		CB/PL02H4	94	D02E-0E1417	76
CB/516HX10	94		CB/806TC	86		CB/827B	91		CB/PL05H4	94	D02E-0E1418	76
CB/516HX12	94		CB/806TM	85		CB/827BD	91		CB/PL06H4	94	D02E-0E1419	76
CB/516HX14	94		CB/806X	88		CB/827TM	85		CB/P22M5	95	D02E-0E1421	76
CB/516PH2	94		CB/807	88		CB/827X	91		CB/SL10H4	93	D02E-0E1422	76
CB/516PH3	94		CB/807IP	88		CB/828	91		CB/SL15H4	93	D02E-0E1424	76
CB/516PH4	94		CB/807IPR	88		CB/829	91		CB/SL20H4	93	D02E-0E1427	76
CB/516PZ2	94		CB/807T	88		CB/829B	91		CB/SL25H4	93	D02E-0E1430	76
CB/516PZ3	94		CB/807TC	86		CB/829BD	91		CB/SL30H4	93	D02E-0E1432	76
CB/516PZ4	94		CB/807TM	85		CB/829TM	85		CB/SL35H4	93	D02E-RE0908	76
CB/516SL08	94		CB/807X	88		CB/829X	91		CB/SL40H4	93	D02E-RE0910	76
CB/516SL10	94		CB/808	88		CB/830	91		CB/SP04	89	D02E-RE0911	76
CB/516SL12	94		CB/808B	88		CB/830TM	85		CB/SP06	89	D02E-RE0912	76
CB/516TX20	94		CB/808BD	88		CB/830X	91		CB/SP06H4	94	D02E-RE0913	76
CB/516TX25	94		CB/808IP	88		CB/841	89		CB/SP08	89	D02E-RE0914	76
CB/516TX30	94		CB/808IPR	88		CB/842	89		CB/SP08H4	94	D02E-RE0915	76
CB/516TX40	94		CB/808T	88		CB/843	89		CB/SP10	89	D02E-RE0916	76
CB/516TX45	94		CB/808TC	86		CB/854	89		CB/ST111	98	D02E-RE0917	76
CB/516TX50	94		CB/808TM	85		CB/855	89		CB/ST112	98	D02E-RE0918	76
CB/516TX55	94		CB/808X	88		CB/856	89		CB/ST113	98	D02E-RE0919	76
CB/516XZ06	94		CB/809	88		CB/858	89		CB/ST113T	98	D02E-RE0922	76
CB/591	90		CB/8094	91		CB/860	89		CB/ST114	98	D02E-RE1413	76
CB/591B	91		CB/8095	91		CB/860300	89		CB/ST25	97	D02E-RE1414	76
CB/591TC	86		CB/8096	91		CB/860301	89		CB/ST31	97	D02E-RE1415	76
CB/591TM	85		CB/8097	91		CB/860302	89		CB/ST31TC	86	D02E-RE1416	76
CB/591X	90		CB/8099	91		CB/860303	89		CB/ST32	98	D02E-RE1417	76
CB/592	90		CB/809B	88		CB/860304	89		CB/ST56	98	D02E-RE1418	76
CB/592B	91		CB/809BD	88		CB/860305	89		CB/ST61	98	D02E-RE1419	76
CB/592BD	91		CB/809IP	88		CB/860306	89		CB/SVB25	89	D02E-RE1421	76
CB/592D	90		CB/809IPR	88		CB/860308	89		CB/T25M5	95	D02E-RE1422	76
CB/592TC	86		CB/809T	88		CB/860310	89		CB/T30M5	95	D02E-RE1424	76
CB/592TM	85		CB/809TC	86		CB/860314	89		CB/TH05H4	93	D02E-RE1427	76
CB/592X	90		CB/809TM	85		CB/860510	89		CB/TH06H4	93	D02E-RE1430	76
CB/593	90		CB/809X	88		CB/861	89		CB/TH07H4	93	D02E-RE1432	76
CB/593B	91		CB/810	88		CB/861314	89		CB/TH08H4	93	D02E-RH0912	76
CB/593TC	86		CB/810IPR	88		CB/861351	89		CB/TH09H4	93	D02E-RH0938	76
CB/593TM	85		CB/810T	88		CB/862	89		CB/TH10H4	93	D02E-RH1412	76
CB/593X	90		CB/811	88		CB/863	89		CB/TH15H4	93	D02F2-0125	75
CB/610	88		CB/811B	88		CB/864	89		CB/TH20H4	93	D02F2-01R	75
CB/611	88		CB/811BD	88		CB/865	89		CB/TR20H4	94	D02F2-1105	75
CB/611TC	86		CB/811IP	88		CB/866	89		CB/TR23H4	94	D02F2-1110	75
CB/612	88		CB/811IPR	88		CB/867	89		CB/TR30H4	94	D02F2-11R	75
CB/612TC	86		CB/811T	88		CB/868	89		CB/TX02H4	93	D02F2-2110	75
CB/613	88		CB/811TC	86		CB/869	89		CB/TX03H4	93	D02F2-2120	75
CB/613TC	86		CB/811TM	85		CB/871	89		CB/TX04H4	93	D02F2-2130	75
CB/619	91		CB/811X	88		CB/872	89		CB/TY01H4	94	D02F2-21R/1	75
CB/620	91		CB/812	88		CB/873	89		CB/TY10H4	94	D02F2-21R/2	75
CB/621	91		CB/812IP	88		CB/874	89		CB/TY20H4	94	D03-2114	75
CB/622	91		CB/812IPR	88		CB/875	89		CB/TY30H4	94	D03-2123	75
CB/660P154	88		CB/812T	88		CB/8806	92		CB4/EST28	93	D03-2133	75
CB/660P255	88		CB/812TC	86		CB/8807	92		CB4/ST25	93	D03-21R	75
CB/660S6H6	88		CB/812TM	85		CB/901	90		CB4/ST49	93	D03F2-0125	75
CB/660T2T3	88		CB/812X	88		CB/902	90		CF-E105	12	D03F2-1112	75
CB/660Z1H4	88		CB/813	88		CB/902TM	85		CF-E108	17	D03F2-2122	75
CB/660Z2H5	88		CB/814	88		CB/903	90		CM-B0	179	D03F2-2133	75
CB/662TM	90		CB/8156	91		CB/911	91		D02E-0910	76	D03F-3110	75
CB/690	91		CB/8157	91		CB/912	91		D02E-1420	76	D03F-3155	75
CB/701	90		CB/8159	91		CB/912TM	85		D02E-1430	76	D03F-3175	75
CB/702	90		CB/820	91		CB/913	91		D02E-0E0908	76	D03F-31R	75
CB/702TM	85		CB/821	91		CB/HX07H4	94		D02E-0E0910	76	D06-21	76
CB/703	90		CB/822	91		CB/HX09H4	94		D02E-0E0911	76	D06-31	76
CB/711	91		CB/823	91		CB/HX13H4	94		D02E-0E0912	76	D20HR-300	76
CB/712	91		CB/824	91		CB/HX15H4	94		D02E-0E0913	76	D20HR-450	76
CB/712TM	85		CB/824TM	85		CB/HX20H4	94		D02E-0E0914	76	D20-P2131	76
CB/713	91		CB/824X	91		CB/HX25H4	94		D02E-0E0915	76	D20-P3141	76
CB/801	88		CB/825	91		CB/HX30H4	94		D02E-0E0916	76	D32-14B012	75
CB/802	88		CB/825TM	85		CB/HX40H4	94		D02E-0E0917	76	D32-14B060	75
CB/803	88		CB/825X	91		CB/PH01H4	93		D02E-0E0918	76	E01-11-0160	99
CB/804	88		CB/826	91		CB/PH02H4	93		D02E-0E0919	76	E01-11-0180	99
CB/805	88		CB/826B	91		CB/PH10H4	93		D02E-0E1413	76	E01-11-0200	99
CB/806	88		CB/826BD	91		CB/PH20H4	93		D02E-0E1414	76	E01-41-0160	99

İNDEKS

ÜRÜN KODU	FIYAT TL	SAYFA NO	ÜRÜN KODU	FIYAT TL	SAYFA NO	ÜRÜN KODU	FIYAT TL	SAYFA NO	ÜRÜN KODU	FIYAT TL	SAYFA NO	
E01-41-0180	99		E36-54-0280D	103		E69-T046	107		F14-001-025	77	F20-130-125	78
E01-41-0200	99		E36-56-0225	103		E69-T468	107		F14-001-080	77	F20-140-125	78
E01-43-0160	99		E36-56-0250	103		E69-YT1	107		F14-001-100	77	F20A-0102	78
E01-43-0180	99		E36-56-0280	103		E70-225-2	106		F14-001-125	77	F20A-0104	78
E01-43-0200	99		E36-56-0280D	103		E75-081	116		F14-001-200	77	F20A-0308	78
E05-44-0160	100		E37-54-0160	104		E80-230	108		F14-001-300	77	F20A-0516	78
E06-11-0140	99		E37-54-0180	104		E80-230R	108		F14-001-500	77	F20-B05	80
E06-11-0160	99		E38-54-0200	104		E80-280R	108		F14-002-025	77	F21-050-150	78
E06-11-0180	99		E50-140-2	104		E81-180	108		F14-002-100	77	F21-060-150	78
E06-41-0140	99		E50-190-2	104		E82-190	108		F14-002-125	77	F21-070-150	78
E06-41-0160	99		E50-240-2	104		E99-41-02A	100		F14-002-150	77	F21-080-150	78
E06-41-0180	99		E50-300-2	104		E99-41-03A	100		F14-002-200	77	F21-100-150	78
E06-43-0140	99		E50-E16	19		E99-41-03B	100		F14-002-300	77	F22-020-060	78
E06-43-0160	99		E50L-170-2	104		E99-41-E0103	25		F14-002-500	77	F22-025-080	78
E06-43-0180	99		E50L-230-2	104		E99-41-W09PH	100		F14-003-150	77	F22-030-080	78
E08-11-0180	99		E50MIC	105		E99-41-W09PZ	100		F14-004-200	77	F22-040-100	78
E08-11-0200	99		E50-R03	104		E99-44-E0404	25		F14C-001-080	81	F22-050-100	78
E08-41-0180	99		E51-190-2	104		E99-CP04A	108		F14C-002-100	81	F22-060-125	78
E08-41-0200	99		E51-240-2	104		E99-CP04A/2	108		F14C-003-150	81	F22-080-150	78
E09-44-0140	99		E52-16-0240	105		E99-E0502	25		F14D-001-080	81	F22-100-150	78
E09-44-0160	99		E52-240-2	104		E99-E10	18		F14D-002-025	81	F22A-0108	78
E15-11-0160	101		E52S-240-2	104		EF-E27	17		F14D-002-100	81	F22A-0116	78
E15-11-0200	101		E53-280-2	104		EF-E34	18		F14D-003-150	81	F22A-0316	78
E15-41-0160	101		E54-200-2	104		EF-E72	18		F17-000-060	78	F22A-0332	78
E15-41-0200	101		E55-16-0290	105		EJ-E07	20		F17-001-025	78	F22A-0532	78
E15-43-0160	101		E55-280-2	104		EL-E28	18		F17-001-080	78	F22A-0564	78
E15-43-0200	101		E55-470-2	104		EL-E34	12		F17-001-300	78	F22A-0764	78
E15XL-340	101		E55-E07	19		ENJ-E21	20		F17-002-025	78	F22A-0964	78
E16-11-0160	101		E55P-180-2	105		F10-025-075	77		F17-002-100	78	F23-020-100	78
E16-11-0200	101		E55P-300-2	105		F10-030-075	77		F17-002-300	78	F23-025-100	78
E16-41-0160	101		E55T-390-2	105		F10-030-100	77		F17-003-150	78	F23-030-100	78
E16-41-0200	101		E55T-500-2	105		F10-035-100	77		F17-004-200	78	F23-040-100	78
E16-43-0160	101		E56-J1	105		F10-040-025	77		F17C-001-080	81	F23-050-100	78
E16-43-0200	101		E56-J2	105		F10-040-075	77		F17C-002-100	81	F23-060-125	78
E16XL-340	101		E56-L1	105		F10-040-100	77		F17C-003-150	81	F23-080-150	78
E17-11-0160	101		E56-L2	105		F10-040-125	77		F17D-001-080	81	F23A-0104	78
E17-41-0160	101		E56-W1	105		F10-040-150	77		F17D-002-025	81	F23A-0308	78
E18-11-0160	101		E60-41-0160	106		F10-040-300	77		F17D-002-100	81	F23A-0316	78
E18-41-0160	101		E60-41-0200	106		F10-045-100	77		F17D-003-150	81	F23A-0516	78
E19D-200	100		E60-44-0160	106		F10-055-025	77		F18-005-060	78	F23A-0532	78
E25-11-0160	102		E60-44-0200	106		F10-055-100	77		F18-006-060	78	F23A-0732	78
E25-41-0160	102		E60-51-0170	106		F10-055-125	77		F18-007-060	78	F24-001-080	79
E25-AS06	102		E60-54-0170	106		F10-055-150	77		F18-008-060	78	F24-002-100	79
E25-AT1	102		E61-K1160	130		F10-055-200	77		F18-009-060	78	F24-003-150	79
E25-BSA22	102		E62-32	106		F10-055-300	77		F18-010-080	78	F25-002-080	79
E25-BSA22R	102		E62-32R	106		F10-060-150	77		F18-015-080	78	F25-003-080	79
E25-BSM20	102		E62-52	106		F10-065-025	77		F18-015-300	78	F25-004-100	79
E25-BSM20R	102		E62-52R	106		F10-065-100	77		F18-020-100	78	F25-005-100	79
E25-CK28	102		E64-44-0190	106		F10-065-125	77		F18-020-300	78	F26/AG	97
E25-CK28H	102		E64-54-0200	106		F10-065-150	77		F18-025-100	78	F26/AG-2	97
E25-CK28R	102		E65-44-0140	108		F10-065-200	77		F18-025-300	78	F26/BDS	96
E25-COS	102		E65-44-0180	108		F10-065-300	77		F18-027-115	78	F26/BR	97
E25-MIC	102		E65-44-0225	108		F10-080-150	77		F18-030-115	78	F26/BR2	97
E25-MMAX	102		E65-44-0310	108		F10-080-175	77		F18-030-300	78	F26/BR3	97
E25-MULTI1	102		E66-44-0140	108		F10-100-200	77		F18-040-130	78	F26/BT	96
E26-11-0160	102		E66-44-0180	108		F10-100-250	77		F18-045-130	78	F26/BTL	96
E26-41-0160	102		E66-44-0225	108		F10-120-250	77		F19-010-080	78	F26/FBT	97
E29-54-0250	103		E66-44-0310	108		F10C-045-100	81		F19-015-080	78	F26/LBT	97
E30-51-0250	103		E67-44-0140	108		F10C-055-100	81		F19-020-100	78	F26/RDF90	96
E30-54-0250	103		E67-44-0180	108		F10C-065-125	81		F19-025-100	78	F26/RDS	96
E30-54-0300	103		E67-44-0225	108		F10C-080-150	81		F19-027-115	78	F26/RDS90	96
E30Q-54-0180	103		E67-44-0310	108		F10C-100-175	81		F19-030-115	78	F26/SBT	97
E30Q-54-0250	103		E68-44-0140	108		F10C-120-200	81		F19-040-130	78	F26/TBT	97
E30Q-54-0300	103		E68-44-0180	108		F10D-030-075	81		F20-040-125	78	F26A/BT4	93
E30W-54-0250	103		E68-44-0225	108		F10D-040-100	81		F20-050-125	78	F28/BT	94
E34-250	103		E68-44-0310	108		F10D-055-125	81		F20-055-125	78	F28-P12	94
E34-250R	103		E69-ES1	107		F10D-065-025	81		F20-060-125	78	F37-06	48
E35-54-0160	103		E69-ESSQ	107		F10D-065-150	81		F20-070-125	78	F37-07	48
E35-54-0180	103		E69-ESSQ/2	107		F10D-080-150	81		F20-080-125	78	F37-08	48
E35-54-0200	103		E69F-ES2	106		F10M-045-100	77		F20-090-125	78	F37-09	48
E36-54-0225	103		E69F-SL	106		F10M-060-150	77		F20-100-125	78	F37-10	48
E36-54-0250	103		E69-NT1	107		F14-000-060	77		F20-110-125	78	F37-15	48
E36-54-0280	103		E69Q-P04	107		F14-000-080	77		F20-120-125	78	F37-20	48

İNDEKS

ÜRÜN KODU	FIYAT TL	SAYFA NO	ÜRÜN KODU	FIYAT TL	SAYFA NO	ÜRÜN KODU	FIYAT TL	SAYFA NO	ÜRÜN KODU	FIYAT TL	SAYFA NO
F37-IP08	48		G05-001-080		109	G99-7025		111	GC185-X10		115
F37-IP09	48		G05-002-100		109	G99-901		110	GC20-19PH2		116
F37-IP10	48		G05-B02		110	G99-BP04		116	GC21-12		115
F37-IP15	48		G05S-002-100		111	G99-BP06		116	GC21-40		115
F37-P06	48		G06-030-080		109	G99-E701		25	GC21-74		115
F99-201	79		G06-040-080		109	G99-P26		117	GC21-77		115
F99-201P	79		G06-050-080		109	GB09-05/2		114	GC22-H10		115
F99-202	79		G06-060-100		109	GB09-06		114	GC22-H11		115
F99-202P	79		G07-050-125		109	GB09-07		114	GC22-H12		115
F99-403	79		G07-055-125		109	GB09-08		114	GC22-H13		115
F99-403P	79		G07-060-125		109	GB09-09		114	GC22-H14		115
F99-405	79		G07-070-125		109	GB09-10		114	GC22-H15		115
F99-501	79		G07-080-125		109	GB09-11		114	GC22-H16		115
F99-501P	79		G07-090-125		109	GB09-12		114	GC22-H17		115
F99-502	79		G07-100-125		109	GB09-13		114	GC22-H18		115
F99-601	80		G07-110-125		109	GB09-14		114	GC22-H19		115
F99-601V	80		G07-120-125		109	GB09-15		114	GC22-H20		115
F99-602	80		G07-130-125		109	GB09-16		114	GC22-H21		115
F99-602V	80		G07-B05		110	GB09-17		114	GC22-H22		115
F99-605	79		G09-11		160	GB09-18		114	GC22-H24		115
F99-606	79		G09-16		160	GB09-19		114	GC22-H27		115
F99-701	80		G09-NC1		111	GB09-22		114	GC22-H30		115
F99-702	80		G10-18-0160		112	GB09-24		114	GC22-H32		115
F99-901	80		G10-18-0180		112	GB09-R06		114	GC28S-H04L		115
F99A-E80	17		G10-18-0200		112	GB14-10		114	GC28S-H05L		115
F99C-601	81		G10H-18-0180		112	GB14-11		114	GC28S-H06L		115
F99C-602	81		G10H-18-0200		112	GB14-12		114	GC28S-H08L		115
F99D-601	81		G12-18-0140		112	GB14-13		114	GC28S-H10L		115
F99D-602	81		G12-18-0160		112	GB14-14		114	GD02-1105		116
F99-E0507	25		G12-18-0180		112	GB14-15		114	GD02-1125		116
F99-E0705	24		G14-18-0180		112	GB14-16		114	GD02-2110		116
F99-E0706	24		G14-18-0200		112	GB14-17		114	GE99-E08		19
F99-E3901	24		G15-18-0160		113	GB14-18		114	GF99-E52		19
F99-E3902	24		G15-18-0200		113	GB14-19		114	GJ36-150		116
F99-E701	24		G16-18-0160		113	GB14-22		114	GK10-030		114
F99-E79	18		G16-18-0200		113	GB14-24		114	GK10-040		114
F99-E81	17		G17-18-0160		113	GB14-R06		114	GK10-050		114
F99-E95	12		G18-18-0160		113	GB21-250		114	GK10-060		114
F99-P41	80		G20-18-0160		113	GB99-E20		19	GK10-080		114
FLR-E36	18		G20-MMAX		112	GC10-19PH2		115	GRT-M35		111
FX-MD	84		G21-18-0160		113	GC10-E52H2		19	GRT-M40		111
G01-025-075	109		G25-58-0250		113	GC11-12		115	H01-12-040		120
G01-030-100	109		G26/BT		109	GC11-40		115	H01-15-040		120
G01-035-100	109		G30-48-0160		113	GC11-72		115	H01-18-060		120
G01-040-100	109		G30-48-0200		113	GC11-75		115	H01-20-060		120
G01-045-125	109		G30-58-0170		113	GC12-H06		114	H01-20-100		120
G01-055-125	109		G40-48-0145		106	GC12-H07		114	H01-25-080		120
G01-065-150	109		G80-AAC1		118	GC12-H08		114	H01-25-100		120
G01-080-175	109		G80-AAC2		118	GC12-H09		114	H01-30-080		120
G01S-035-100	111		G80-MDC2		118	GC12-H10		114	H01-30-100		120
G01S-040-100	111		G85-AAC1		119	GC12-H11		114	H01-30-150		120
G01S-055-125	111		G85-ADC1		119	GC12-H12		114	H01-35-080		120
G01S-065-150	111		G90-IR550		119	GC12-H13		114	H01-40-080		120
G02-000-060	109		G90-IR750		119	GC12-H14		114	H01-40-100		120
G02-001-080	109		G99-0431		117	GC12-H15		114	H01-40-150		120
G02-002-100	109		G99-0431A26		117	GC12-H16		114	H02-00-060		120
G02-002-150	109		G99-0431A27		117	GC12-H17		114	H02-0-060		120
G02-003-150	109		G99-0431A32		117	GC12-H18		114	H02-1-080		120
G02S-001-080	111		G99-0431A32H		117	GC12-H19		114	H03-0-060		120
G02S-002-100	111		G99-18-02A		112	GC12-H20		114	H03-1-080		120
G03-000-060	109		G99-18-03A		112	GC12-H21		114	H04-04-040		120
G03-001-080	109		G99-18-05PH		112	GC12-H22		114	H04-05-040		120
G03-002-100	109		G99-18-05PZ		112	GC18S-H04		114	H04-06-040		120
G03-002-150	109		G99-18-E0103		25	GC18S-H05		114	H04-07-040		120
G03-003-150	109		G99-18-W09PH		116	GC18S-H06		114	H04-08-040		120
G03S-001-080	111		G99-18-W09PZ		116	GC18S-H08		114	H04-09-060		120
G03S-002-100	111		G99-18-W12PH		116	GC18S-T20		114	H04-10-060		120
G04-010-100	109		G99-18-W12PZ		116	GC18S-T25		114	H04-15-060		120
G04-015-100	109		G99-401		110	GC18S-T27		114	H04-20-060		120
G04-020-100	109		G99-402		110	GC18S-T30		114	H05-02-040		120
G04-025-125	109		G99-701		110	GC18S-T40		114	H05-05-040		120
G04-027-150	109		G99-701S		111	GC18S-T45		114	H06-15-040		120
G04-030-150	109		G99-702		110	GC18S-X08		115	H06-20-060		120
									H06-25-080		120
									H06-30-080		120
									H06A-0050		120
									H06A-0116		120
									H06A-0332		120
									H06A-0764		120
									H20C-118SB		121
									H20S-120FL		121
									H20S-120SB		121
									H20T-120SB		121
									H20-W04		122
									H20-W06		122
									H21N-120SB		121
									H21S-125SB		121
									H22-130		121
									H23F-130		122
									H23S-130		121
									H24-130		122
									H25-155		122
									H26-130		122
									H27-130		122
									H30C-105SB		122
									H30S-110FL		122
									H30S-110SB		122
									H30T-110SB		122
									H30-W04		123
									H30-W06		123
									H30-W10		123
									H31N-120SB		123
									H31S-120SB		123
									H33F-120		123
									H33S-120		123
									H34S-115		123
									H35S-140		123
									H36-120		123
									H37-120		123
									H40-00-SA		124
									H40-1-SA		124
									H40-2A-SA		124
									H40-3C-SA		124
									H40-5-SA		124
									H40-7-SA		124
									H40-AA-SA		124
									H40-R04		124
									H43-120-SA		124
									H43-125B-SA		124
									H43-140-SA		124
									H43G-150B-SA		124
									H43G-150-SA		124
									H44-160B-SA		124
									H44-160-SA		124
									H44T-160-SA		124
									H45D-150B-SA		124
									H45D-150-SA		124
									H55		125
									H55-SC010		125
									H57-1516		125
									H59AL		125
									H60-3		125
									H62-YC		125
									H63		125
									H64		125
									H65-10		125
									H99-04-06		121
									H99-06-06		121
									H99-12-06		120
									H99-31-E0310		25
									H99-E06		25
									H99-JK-05		121
									H99-JK-06		121
									H99-N80		126
									H99-N80A3		

İNDEKS

ÜRÜN KODU	FIYAT TL	SAYFA NO	ÜRÜN KODU	FIYAT TL	SAYFA NO	ÜRÜN KODU	FIYAT TL	SAYFA NO	ÜRÜN KODU	FIYAT TL	SAYFA NO	ÜRÜN KODU	FIYAT TL	SAYFA NO
HLD-0564		52	J19-220		130	J40J-WC100		133	J56-106		136	J64-206H		137
I01-10		127	J22-215C		130	J40J-WF100		132	J56-106H		136	J64-208		137
I01-10/A		127	J22-215CR		130	J40J-WF100C		133	J56-108		136	J64-208H		137
I01-15		127	J22-215P		130	J40-P13		132	J56-108H		136	J64-210		137
I01-15/A		127	J22-215PR		130	J40-PD1		132	J56-110		136	J64-210H		137
I01-20		127	J22-215R		130	J40-PD2		132	J56-110H		136	J64-212		137
I01-20/A		127	J22-215RR		130	J40R-DH225		132	J56-112		136	J64-212H		137
I02-10		127	J22A-200		131	J40R-DH225B		132	J56-112H		136	J65-106		137
I02-15		127	J22A-200R		131	J40R-MB150		132	J56-206		136	J65-106H		137
I02-20		127	J23-190		131	J40R-MB225		132	J56-206H		136	J65-107		137
I06-10-2		127	J30-300		131	J40R-MB225B		132	J56-208		136	J65-107H		137
I06-10-2/A		127	J32-300		131	J40R-ME150		132	J56-208H		136	J65-108		137
I06-10-2/B		127	J35-188		131	J40R-PV210F		132	J56-210		136	J65-108H		137
I06-12-2		127	J35-24B		131	J40R-PV210FB		132	J56-210H		136	J65-204		137
I06-12-2/A		127	J36-150		131	J40R-WL240		132	J56-212		136	J65-205		137
I06-12-2/B		127	J36-R		131	J44-067		131	J56-212H		136	J65-206		137
I06-14-2		127	J40-014		131	J45C		133	J56-306		136	J65-245		137
I06-14-2/A		127	J40-016		131	J45C/D		133	J56-306H		136	J65D-207		137
I06-14-2/B		127	J40-017		131	J45C/T		133	J56-308		136	J66-640		137
I06-18-2		127	J40-019		131	J45CM		133	J56-308H		136	J66-848		137
I06-18-2/A		127	J40-020		131	J45CP		133	J56-310		136	J66-855		137
I06-18-2/B		127	J40-021		131	J45CPM		133	J56-310H		136	J67-108		138
I06-24-2		127	J40-022		131	J45-R		134	J56-312		136	J67-108H		138
I06-24-2/A		127	J40-024		131	J45-RDM		134	J56-312H		136	J67-110		138
I06-24-2/B		127	J40-025		131	J46C		134	J57-106		136	J67-110H		138
I06-36-2		127	J40-027		131	J46CPM		134	J57-106H		136	J68-108		138
I06-36-2/A		127	J40-029		131	J46-R		134	J57-108		136	J68-108H		138
I06-36-2/B		127	J40-030		131	J46-R/30		134	J57-108H		136	J68-110		138
I11-40		127	J40-032		131	J46SL		134	J57-110		136	J68-110H		138
I11-40R		127	J40-033		131	J47C-S		134	J57-110H		136	J68-112		138
I11-60		127	J40-035		131	J47-R		134	J57-112		136	J68-112H		138
I11-60R		127	J40-037		131	J47-RH		134	J57-112H		136	J70-108		138
I12-40		127	J40-038		131	J47-RS		134	J57-206		136	J70-108H		138
I12-40R		127	J40-040		131	J47SPQ		133	J57-206H		136	J70-110		138
I20-190		128	J40-041		131	J47TK		133	J57-208		136	J70-110H		138
I20-190R		128	J40-043		131	J47TK-S		133	J57-208H		136	J70-112		138
I21-42-2		128	J40-044		131	J49		166	J57-210		136	J70-112H		138
I21-42-2R		128	J40-046		131	J49M		134	J57-210H		136	J71-03		138
I30-2		128	J40-048		131	J49-R		134	J57-212		136	J71-04		138
I30-2R		128	J40-051		131	J55-106		135	J57-212H		136	J71-05		138
I32-2		128	J40-052		131	J55-106H		135	J58-106		136	J71-06		138
I32-2R		128	J40-054		131	J55-108		135	J58-106H		136	J72-0851A		137
I32-2R		128	J40-057		131	J55-108H		135	J58-108		136	J72-0851B		137
I34		128	J40-060		131	J55-110		135	J58-108H		136	J72-0852B		137
I34-2R		128	J40-064		131	J55-110H		135	J58-110		136	J72-1051A		137
I38-2		128	J40-065		131	J55-112		135	J58-110H		136	J72-E0811		25
I50		128	J40-067		131	J55-112H		135	J58-112		136	J75-B26		139
J01-250L		129	J40-068		131	J55-206		135	J58-112H		136	J75-C26		139
J01-250R		129	J40-070		131	J55-206H		135	J58-206		136	J75-F26		139
J04-250L		129	J40-073		131	J55-208		135	J58-206H		136	J75-H26		139
J04-250R		129	J40-076		131	J55-208H		135	J58-208		136	J75-HR26		139
J04-250S		129	J40-079		131	J55-210		135	J58-208H		136	J75-K26		139
J04-300S		129	J40-083		131	J55-210H		135	J58-210		136	J75M-R05		139
J04H-250L		129	J40-086		131	J55-212		135	J58-210H		136	J75-O26		139
J04H-250R		129	J40-089		131	J55-212H		135	J58-212		136	J75-R06		139
J04-R03		129	J40-092		131	J55-306		135	J58-212H		136	J75-R12		139
J06-200-2		129	J40-095		131	J55-306H		135	J59-106		137	J75-R26		139
J06-250-2		129	J40-098		131	J55-308		135	J59-106H		137	J75-S26		139
J06-300-2		129	J40-102		131	J55-308H		135	J59-108		137	J75-TS26		139
J10-450		130	J40-105		131	J55-310		135	J59-108H		137	J76-R06		139
J10-450R		130	J40-111		131	J55-310H		135	J59-110		137	J80-200		134
J10-600		130	J40-114		131	J55-312		135	J59-110H		137	J81-200		134
J10-600R		130	J40-121		131	J55-312H		135	J59-112		137	J82-150		134
J10-750		130	J40-127		131	J55F-206		135	J59-112H		137	J82-200		134
J10-750R		130	J40-140		131	J55F-206H		135	J59-206		137	J83-200		134
J10-900		130	J40-152		131	J55F-208		135	J59-206H		137	JL-E53		19
J10-900R		130	J40-A1		132	J55F-208H		135	J59-208		137	JLR-E62		12
J16-180B		130	J40-A2		132	J55F-210		135	J59-208H		137	JP99-E06		25
J16-180S		130	J40-A3		132	J55F-210H		135	J59-210		137	K10-020-100		47
J17-190		130	J40-A4		132	J55F-212		135	J59-210H		137	K10-025-100		47
J17-190B		130	J40J-A100		133	J55F-212H		135	J59-212		137	K10-030-100		47
J18-230		130	J40J-MB075		133	J55W-206		135	J59-212H		137	K10-040-150		47
J18-250		130	J40J-WB100		132	J55W-206H		135	J64-206		137	K10-050-150		47

İNDEKS

ÜRÜN KODU	FIYAT TL	SAYFA NO	ÜRÜN KODU	FIYAT TL	SAYFA NO	ÜRÜN KODU	FIYAT TL	SAYFA NO	ÜRÜN KODU	FIYAT TL	SAYFA NO			
K10-060-200		47	L/0050		44	L12-R40		140	L50-W6-2		142	N12-P1630		145
K10-070-200		47	L/0102		44	L12-R50S		140	L99-E02		26	N12-P1660		145
K10-080-200		47	L/0104		44	L16-30		141	L99-E08		26	N12-P16KIT		145
K10-100-200		47	L/0108		44	L16-40		141	LPR-E17		20	N13-10P03		146
K10A-0104		47	L/0116		44	L16-50		141	LT/12		43	N13-PC14		146
K10A-0108		47	L/0304		44	L17-40		141	LT/12D		43	N14-016514		147
K10A-0308		47	L/0308		44	L18-1000		141	LT/13AF		44	N14-016606		147
K10A-0316		47	L/0316		44	L18-1500		141	LT/7		42	N14-017612		147
K10A-0332		47	L/0332		44	L18-750		141	LT/700		45	N14-017614		147
K10A-0516		47	L/0364		44	L20-0401		142	LT/700B		46	N14-018616		147
K10A-0532		47	L/0508		44	L20-0403		142	LT/700IPR		46	N14-019515		147
K10A-0564		47	L/0516		44	L20-04SW		142	LT/700L		45	N14-01K09		147
K10A-0732		47	L/0532		44	L20-120		142	LT/700TL		46	N14-01532		147
K10A-0764		47	L/0564		44	L25-150-2		141	LT/740		46	N14-01536		147
K10A-0964		47	L/0716		44	L25-200-2		141	LT/800		43	N14-027414		147
K10T-030		47	L/0732		44	L25-250-2		141	LT/800AF		44	N14-029215		147
K10T-040		47	L/0764		44	L25-250G-2		141	LT/800CP		46	N14-031		147
K10T-050		47	L/0916		44	L25-300-2		141	LT/800D		43	N14-031SQ		147
K10T-060		47	L/0964		44	L25-300G-2		141	LT/9		43	N14-032		147
K11-020-100		47	L/1.3		42	L27-125		141	LT/900		44	N14-032SQ		147
K11-025-100		47	L/1.5		42	L27-150		141	LT/900AF		45	N14-033		147
K11-030-100		47	L/10		42	L27-175		141	LT/900C		44	N14-0451		147
K11-040-150		47	L/11		42	L28-125		141	LT/900CP		46	N14-0452		147
K11-050-150		47	L/12		42	L28-150		141	LT/900D		44	N14-0453		147
K11-060-200		47	L/13		42	L29-3		141	LT/9AF		44	N14-051		147
K11-080-200		47	L/14		42	L29-4		141	LT/9CP		46	N14-051R		147
K11-100-200		47	L/16		42	L29-5		141	LT/9D		43	N14-052		147
K12-009-100		48	L/17		42	L29AT		141	LT12/800		43	N14-052R		147
K12-010-100		48	L/19		42	L29ATR		141	LT12/900		44	N14-061S		147
K12-015-100		48	L/2		42	L30-2		141	LT13/700		45	N14-06R		147
K12-020-150		48	L/2.5		42	L30-3		141	LT13/700L		45	N14-071		148
K12-025-150		48	L/2.5B		42	L30-4		141	LT13/800AF		44	N14-072		148
K12-027-150		48	L/22		42	L30-5		141	LT13/900AF		45	N14-07DSG1		148
K12-030-150		48	L/24		42	L30-6		141	LT27/800CP		47	N14-07DSG2		148
K12-040-150		48	L/27		42	L31-10		141	LT27/900CP		47	N14-081		148
K20-06		42	L/3		42	L31-2		141	LT7/800		43	N14-10		148
K20-07		42	L/3.5		42	L31-3		141	LT7/900		43	N14-12F10		148
K20-08		42	L/32		42	L31-4		141	M01-0810		174	N14-12P14		148
K20-08L		42	L/4		42	L31-5		141	M01-1310		174	N14-12R09		148
K20-09		42	L/4.5		42	L31-6		141	M01-1615		174	N14-12S08		148
K20-10		42	L/5		42	L31-8		141	M01-2015		174	N14-12S10		148
K20-10L		42	L/6		42	L35-61		141	M01-2520		174	N14-12S12		148
K20-11		42	L/7		42	L35-62		141	M01-3520		174	N14-12VAG.B		148
K20-12		42	L/8		42	L35A-11		142	M01-S05		174	N14-12X16		148
K20-13		42	L/9		42	L35A-51		142	M05-1010		174	N14-E11		26
K20-13L		42	L01-100		140	L40G		142	M05-1616		174	N15-K1BMW		150
K20-B06		42	L01-1000		140	L40P-03		142	M10S-0460		174	N15-K1FIA		150
K99-10-06		47	L01-1500		140	L40P-04		142	M10S-0680		174	N15-K1FIA/3		150
K99-10A-E06		22	L01-200		140	L40P-05		142	M10S-1011		174	N15-K1VAG		149
K99-10A-E15		22	L01-2000		140	L40P-06		142	M20-KIT1		174	N15-K2BMW		150
K99-10A-M10		47	L01-300		140	L40P-08		142	N11-02A		143	N15-K2REN		151
K99-10A-ME		47	L01-500		140	L40P-10		142	N11-02A/4		143	N15-K2VAG.12		149
K99-10-E06		22	L01-H1000		140	L40P-12		142	N11-02A-2		143	N15-K2VAG.U		149
K99-10-E15		22	L01-H1500		140	L40-P14		142	N11-02B-2		143	N15-K3BMW		150
K99-10-M08		47	L01-H2000		140	L40P-14		142	N11-03		143	N15-K3FIA		150
K99-10-ME		47	L01-H300		140	L40P-16		142	N11-04		143	N15-K3REN		151
K99-10-ME		47	L01-H500		140	L40P-18		142	N11-05		144	N15-K3REN/3		151
K99-11-M08		47	L02-08		140	L40P-20		142	N11-06		144	N15-K3VAG		149
K99-12-06		48	L02-12		140	L40P-22		142	N11-20		144	N15-K4VAG		149
K99-12-E06		22	L02-16		140	L40P-25		142	N12-01		144	N15-M1FRD		151
K99-12-E14		22	L02-24		140	L40P-30		142	N12-01B		144	N15-M1REN		151
K99-12-M07		48	L02-32		140	L50-06-2		142	N12-04AB		144	N15-M1VAG		150
K99-12-ME		48	L02F-12		140	L50-08-2		142	N12-05		144	N15-T1BMW		150
K99-F1		48	L07F-16		140	L50-10-2		142	N12-05P		144	N15-T1PE		149
K99-F2		48	L12-30		140	L50-12-2		142	N12-10		145	N15-T1REN		151
K99-F2M		48	L12-40		140	L50-14-2		142	N12-10HEN		145	N15-T2UNI		149
K99-F2M/2		48	L12-50		140	L50-16-2		142	N12-10L		145	N15-T3UNI		149
K99-F3		48	L12C-35		140	L50-18-2		142	N12-12		145	N16-0101		151
KNR-E37		12	L12C-35R		140	L50-20-2		142	N12-12HD		145	N16-06		151
L/0028		42	L12DB-35		140	L50-22-2		142	N12-13		145	N16-07		151
L/0028		44	L12DB-45		140	L50-25-2		142	N12-1625		145	N16-1001		151
L/0035		42	L12DB-50		140	L50-30-2		142	N12-25AT		145	N16-1002		151
L/0035		44	L12-R30		140	L50-B4-2		142	N12-P1615		145	N16-1003		151

İNDEKS

ÜRÜN KODU	FIYAT TL	SAYFA NO	ÜRÜN KODU	FIYAT TL	SAYFA NO	ÜRÜN KODU	FIYAT TL	SAYFA NO	ÜRÜN KODU	FIYAT TL	SAYFA NO
N16-1004		151	N33-01BPF		157	P07-20		163	R05-1000		177
N16-1005		151	N33-01SPF		157	P07-30		163	R05-200		177
N16-1110		152	N33-02CW		158	P07-50		163	R05-300		177
N16-1116		152	N33-02DE		158	P10-10		163	R05-500		177
N17-052208		152	N33-02HE		158	P10-20		163	R08-500		176
N17-052211		152	N33-02PW		158	P10-30		163	R08-500SN		176
N17-052708		152	N33-02PWC		158	P15-015		164	R08-FSN		176
N17-05L14		152	N33-02TO		158	P15-030		164	R08-FSY		176
N17-05L17		152	N33-02UA		157	P15-050		164	R09B-125		174
N17-05L19		152	N33-03DS		158	P15-100		164	R09B-150		174
N17-E09		26	N33-03SL		158	P17-B03		163	R09B-200		174
N18-1522S		152	N33-03SS		158	P21-012M		164	R10-CLR		167
N18-1522SL		152	N33-04		158	P21-030		164	R10-COM1		169
N18-CC		152	N33-04F		158	P21-040		164	R10F-SLIM1		168
N18-CCR		152	N33-04R		158	P21-050		164	R10F-SLIM2		168
N21-0101		152	N33-04RTC		158	P21-060		164	R10-MAX01		165
N21-0102		152	N33-04R1D		158	P21-060M		164	R10-MAX02		165
N21-0302		153	N33-04R2C		158	P21-070		164	R10-MIDI		166
N21-04P12		153	N33-04R2D		158	P21-080		164	R10-MIDI/UV		167
N21-04P21		153	N33-04R3D		158	P21-080M		164	R10-MINI1		166
N21-05		153	N33-05C		159	P21-100		164	R11-MINI		173
N21-10		153	N36-1002		159	P21-100M		164	R11-PEN		173
N21-20BC		153	N36-CS0722		159	P21-120		164	R11-PRO		173
N21-20BCW		153	N36-E04		26	P21-150		164	R12-BAT1		169
N21-30DST		153	N36-WH2		159	P24M-022		164	R12-PRO1		169
N22-01K05		153	N36-WRT		159	P26-BE1		164	R14-CF10		170
N22-0202		153	N37-02AJ1		159	P26-BH1		164	R14-CF20		170
N23-011		155	N37-02FR1		159	P26-BV1		164	R15-0500		175
N23-032038		155	N37-02HD1		159	P26-BV2		164	R15-1000		175
N23-03K1AU		154	N37-02S11		159	P26-SH1		164	R15-1800		175
N23-03K1BMW		154	N37-02SM1		159	P26-SH2		164	R15-3000		175
N23-03K1VW		154	N37-02SM2		159	P45A		163	R15-HTM		176
N23-03K2BMW		154	N41-10		160	P45D		163	R15-NTM		176
N23-03K2VW		154	N42-01K13		160	P47-025		163	R15-TM10		176
N23-0525		155	N42-01M10		160	P47-050		163	R16-700		176
N23-0604		155	N42-01T50		160	P47-075		163	R18R		177
N23-0750		155	N43-01K1UNI		160	P47-100		163	R18S		177
N23-0811D		155	N43-01K1VAG		160	P54-20S		164	R20R		176
N23-0812G		155	N43-01T01		161	P54A-25S		164	R20RP		176
N23-0825		155	N43-01T01S		161	P55-52MW		164	R20RS		176
N23-0831		155	N43-01T02		161	R.L7R		172	R20S		176
N23-0832		155	N43-01T02S		161	R.P5R		171	R21P		176
N23-08MC		155	N43-01T04		161	R.P6		171	R21-P19		178
N23-08TD		155	N43-01T04S		161	R.P7		171	R25-P05		177
N23-08VCT		156	N43-01T10		161	R.P7R		172	R26A-B05		177
N23-10		156	N43-01T11		161	R.P-BP		172	R26-M25		178
N23-11		156	N43-01T12		161	R01-AS1		175	R28-P0524		177
N23-1218		156	N43-01T13		161	R01-E05		26	R28-P1214		177
N23-1225		156	N43-01T14		161	R01-STD		175	R28-SC08		177
N23-1230		156	N43-01T15		161	R02-280		175	R28-SC14/1		177
N23-1240		156	N43-01T20		161	R03K-M03		175	R28S-P1420		177
N23-1246		156	N43-01T30		161	R03K-M04		175	R30-06		178
N23-1418		156	N43-01T31		161	R03K-M05		175	R30-08		178
N23-1424		156	N43-01T32		161	R03K-M06		175	R30-10		178
N23-15C		156	N43-1020		160	R03K-NRC		174	R30-12		178
N23-15P		156	N43-E09		26	R03K-PT		175	R30-R04		178
N23-1850		156	P01-0522		162	R03K-RTC		175	R32-08		178
N23-1855		156	P01-0527		162	R03K-S03		175	R32-10		178
N23-19DH		156	P01-0827		162	R03K-S04		175	R32-11		178
N23-38		157	P03-0316		162	R03K-S05		175	R32-12		178
N23-39		157	P03-0519		162	R03K-S06		175	R32-13		178
N23-42		156	P03-0525		162	R04K		174	R32-14		178
N23-E05		26	P05-0316		162	R04K-AS		175	R32-15		178
N30-E05		20	P05-0516		162	R04K-M04		175	R32-16		178
N30-E09		20	P05-0519		162	R04K-M05		175	R32-17		178
N30-E10		20	P05-0525		162	R04K-M06		175	R32-18		178
N30-E12		20	P05-1025		162	R04K-M08		175	R32-19		178
N31-1105		157	P05A-0316		162	R04K-M10		175	R32-21		178
N31-12		157	P05A-0519		162	R04K-S04		175	R32-22		178
N31-13		157	P05-AD2		163	R04K-S05		175	R32-24		178
N31-14		157	P05B-0519		162	R04K-S06		175	R32-27		178
N31-APW2		157	P05B-1025		162	R04K-S08		175	R32-P11		178
N33-01BMC2/MS		157	P05S-0519		162	R04K-S10		175	R35CT		179
									R35DE		179
									R36-1		178
									R36-2		178
									R36-3		178
									R36-4		178
									R36-B04		178
									R37-25		179
									R40-4		179
									R41-1		179
									R99-E24		26
									R99-E32		26
									S4000M/6ST1		83
									S4000M/6ST2		83
									S4000M/7ST1		83
									S4000M/7ST2		83
									S4000M-1-067		180
									S4000M-1-067P		180
									SC22H-1-184		180
									SCB-1-1008		180
									SE11-1-040		180
									SE11-24		100
									SE41-1-040		180
									SE41-24		100
									SE43-1-040		180
									SE43-24		100
									SF10-1-067		180
									SF10-1-067P		180
									SF18-1-071		180
									SF99-601		80
									SF99-601V		80
									SF99-602		80
									SF99-602V		80
									SF99-701		80
									SF99-702		80
									SG01-1-067		180
									SG01-1-067P		180
									SG18-1-040		180
									SG18-24		112
									SG99-701		110
									SG99-702		110
									SH20-1-040		180
									SH99-1-080		180
									SJ72-1-60		180
									SK10-1-54		180
									SP05-0316-180		180
									SP05-0516-120		180
									SP05-0519-120		180
									SP05-0525-108		180
									SP21-54		180
									Z/12		84
									Z/40		84
									Z/55		84

Ceta Form Garantisi

Ceta Form ürünleri hammadde ve üretimden kaynaklanabilecek hatalara karşı tam garantilidir. Bu garanti hatalı ürünün tamiri veya yerine yenisinin verilmesini kapsar.

Amaç dışı kullanım veya kullanıcı hatası sonucu hasar görmüş ürünler garanti kapsamına girmez. Aletin makul kullanım ömrü içerisinde uğrayacağı aşınma da garanti kapsamı içinde değildir.

Bilgilendirme

Katalogta yer alan ürünler ve ürünlerin görsellerine ait tüm haklar firmamıza aittir. Ürün ve ürün görselleri CETA FORM EL ALETLERİ SAN VE TİC A.Ş.'nin izni dışında üretilemez, kısmen ya da tamamen kopyalanamaz, dağıtılamaz, kullanılamaz ve kayda alınmaz. Ürün iyileştirme faaliyetlerimiz doğrultusunda gerçekleştirdiğimiz tasarım ve ölçü değişiklikleri, ürün iptalleri ve ilgili standart değişiklikleri ile basımdan kaynaklı hatalar firmamız sorumluluğunda değildir.

İstisnai Durumlar

Takım dolapları, takım çantaları, tork anahtarları, makaslar, metreler, maket bıçakları ve aydınlatma ürünlerinde garanti süresi 2 yıldır.

Bits uçlar, pançlar, eğeler, maket bıçağı yedekleri, testere yedekleri, dekapaj uçları, plastik çekiç kafaları ve perçin pensi yedek parçaları gibi sarf malzemelerinde garanti uygulaması yoktur.

Yanlış Kullanım Örnekleri

Aşağıda belirtilen kullanım talimatlarına uymaz, aletlerinizin size uzun yıllar boyunca hizmet etmesini ve garanti sürelerimizden tam anlamıyla faydalanmanızı sağlayacaktır. Ürünlerin hatalı kullanımından doğan ve aşağıdaki kullanım hatalarını içeren her türlü hasar gerek bayimiz gerekse firmamızda tespit edildiğinde ürün garanti kapsamına girmeyecektir.

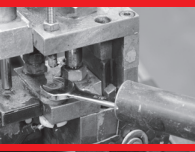

Anahtarları uzatma kolları ile birlikte kullanarak gereğinden fazla güç uygulamayınız.



Cırcırlı kombine anahtar serilerinin cırcır kısmını boşluk almada kullanınız, boşluk alma işleminden sonraki son sıkma işlemini sabit çene ile gerçekleştiriniz.



Tork anahtarları serilerimiz ayarladığınız sıkma değerine geldiğinde klik sesi çıkarmakta ve kısa mesafeli boşluk hissedilmektedir. Bundan sonra uygulanacak yük yay ve dişli mekanizmasını bozacaktır.



Manuel kullanım lokmaları kesinlikle havalı aletlerde kullanmayınız. Havalı aletlerde kullanılan modeller siyah tip lokma serileridir.



Tornavidaları keski, çekiç ve levyelerin yapacağı işlerde kullanmayınız. Ayrıca tornavida sapındaki delikler askı amaçlı açıldığından dolayı güç almak amaçlı kullanmayınız.



Tornavida ve bits uç seçiminde kullanmış olduğunuz vidaya uygun ağızlı ürün seçilmelidir. Vida ölçülerine göre büyük veya küçük seçilmiş tornavida ve bitsler, uçlara ve vidaya zarar verecektir. Ayrıca pozitrev ve yıldız uçlu vida ayırma dikkat edilmesi ve seçimin buna göre yapılması gerekmektedir.



Penseler kesme kapasitelerinin üzerindeki malzemeleri kesmek için kullanılmamalıdır. Elektrik üzerinde çalışırken ark yaptırmamaya dikkat edilmelidir.



Kablo kesicileri bakır malzeme dışında ve kesme kapasitesi değerlerinin haricinde kullanmayınız.



Çekiçleri kendisinden daha sert malzemeye vurmuyunuz. (50-58 Hrc).



Şerit metrelerin bir ölçü aleti hassasiyetinde kullanılması gerekmektedir. Tozlu ve harçlı ortamlarda kullanım durumunda şeritlerin sarma aşamasında temiz kalmasına dikkat edilmelidir. Ayrıca sulu ve nemli ortamlardan uzak tutulmalıdır.



Çekiçler dışındaki aletler çekiç yerine kullanılmamalıdır.



Aletlerinizi değişik amaçlarla kullanmak için şeklini ve ölçülerini değiştirmeyiniz.



form	H	M
	2.5	3.0

CAPACITİ

OPER CODE (i.)

Lütfen aletlerinizi katalog değerlerinde belirtilen kapasitelere uyarak kullanınız.



Özel amaç için tasarlanmış topbaşı allen anahtarların döndürme momentleri, normal allen anahtarlara göre daha düşüktür. Lütfen bunu göz önünde bulundurarak kullanınız.

CETA FORM

Fiyatlarımıza KDV dahil değildir.



CETA FORM EL ALETLERİ SANAYİ VE TİCARET A.Ş.
Mermerciler Sanayi Sitesi 3.Cadde No: 3
34520 Beylikdüzü / İstanbul
Tel : +90 212 876 46 41 (pbx)
Fax : +90 212 876 46 40
satisdestek@cetaform.com
www.cetaform.com



CETA FORM Limited
5,04 Windsor House Cornwall Road Harrogate
North Yorkshire HG1 2PW United Kingdom
Tel : +44 (0)845 308 1440
uksales@cetaform.com

www.cetaform.co.uk